

SOUTH SIDE

HSS5"x5"x5/16" FABRICATE (1)

94/ST704

COLUMN S5

SCALE: 1/2"=1'-0"



MARK ON COLUMN

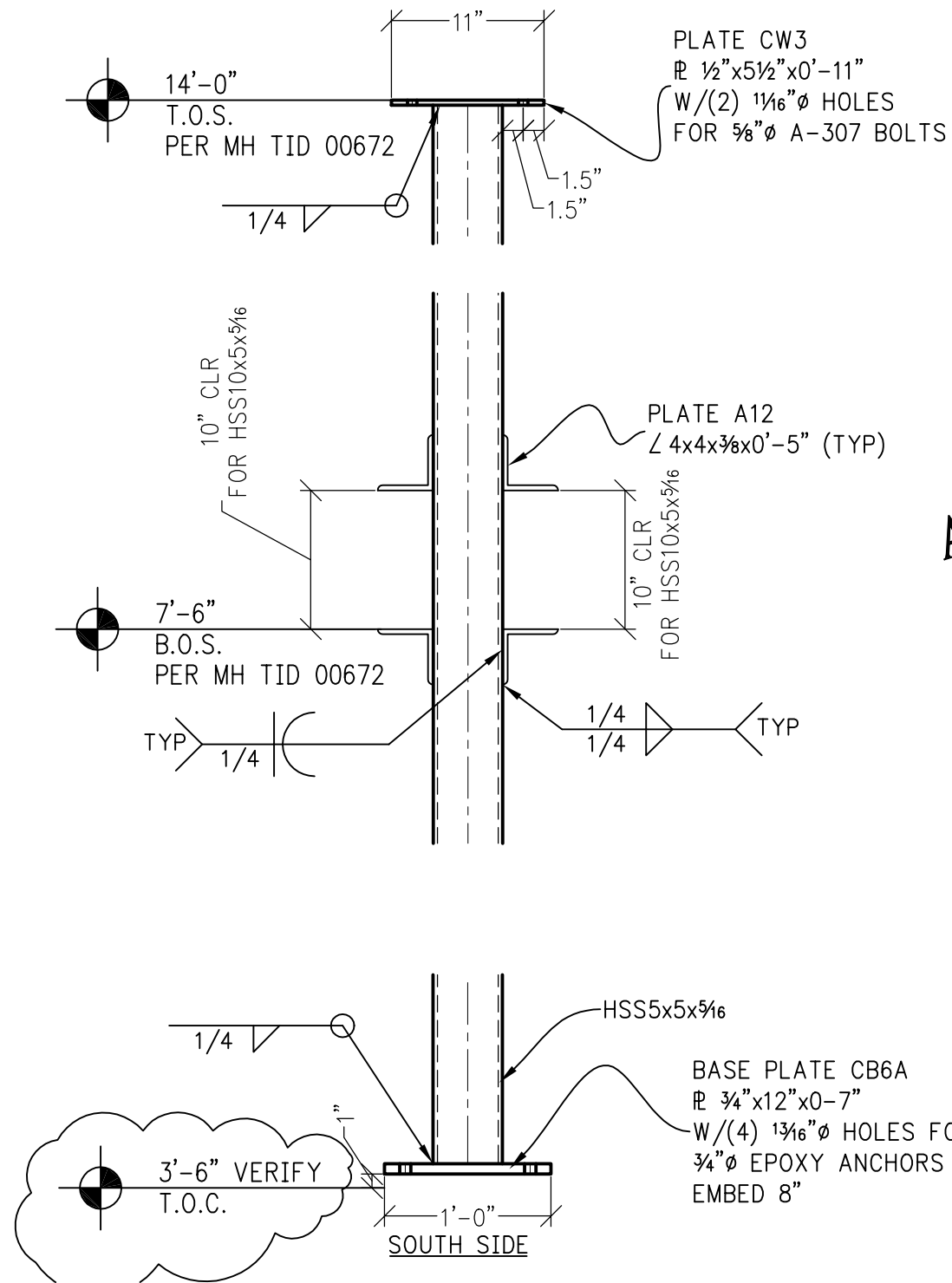

APPROVED FOR FABRICATION

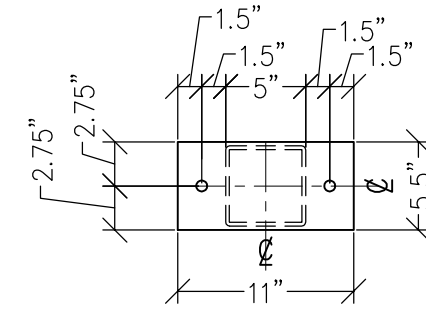
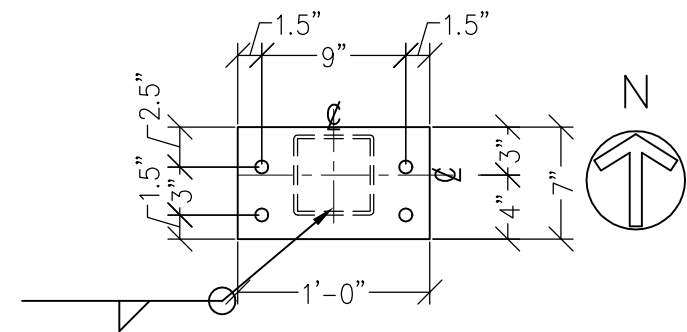

STEEL - U.N.O.

TYPE OF MEMBER	ASTM SPEC.	F _y
WIDE FLANGE SHAPES	A992	50 KSI
ALL OTHER SHAPES	A36	36 KSI
PLATE	A36 OR A572	36 KSI (MIN)
PIPE SECTIONS	A500 (GRADE B)	42 KSI
STRUCTURAL TUBING (SQ. OR RECT.)	A500 (GRADE B)	46 KSI
CONN. BOLTS	A307	36 KSI
HEADED SHEAR STUDS	A108	49 KSI
THREADED RODS	A36	36 KSI

Paradise Ventures, Inc.

P.O. Box 2441
Wenatchee, WA 98807
509.670.9375 - FAX 881.2720

SHOP DRAWINGS
WENATCHEE QUALITY WELDING
MOSES LAKE CIVIC CENTER

DWG: MOSES LAKE CIVIC CENTER.DWG

COLUMN

DRAWN BY: COOKE
CHECKED BY:

DATE: 01-03-2011

S5