

In State Communication Techniques for ARES

By

Eldon Peterson, MSEE

W5UHQ

September 13 , 2014

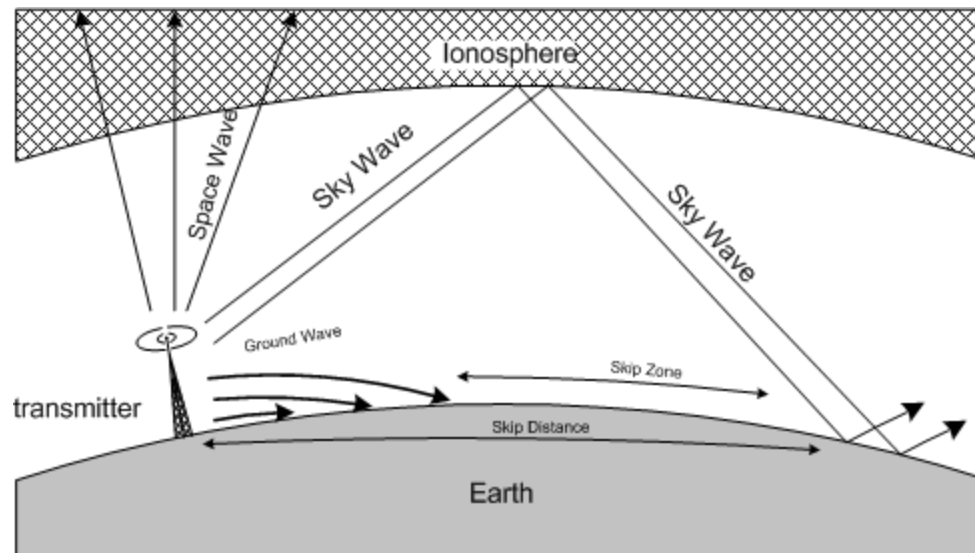

In State Communication Techniques Overview

- Purpose
- Scope
- Comparison of candidate Methods
- Theory Framework of methods.
- Historical Review
- Practical Hints and antennas
- Summary

In State Communications Techniques Overview

- Purpose - The purpose of this presentation is to review technology supporting short range (within the state of Ohio) communications. This technology is often opposite what of what hams think about in terms of working the world.
- How can we as amateurs lay down a system to support such a system.

In State Communications Technique Overview

- Scope - This presentation is limited to a quick overview of potential technology and is targeted for high reliability and availability needed for the ARES “when all else fails” mission which we have yet to demonstrate in Ohio.
- The purpose of the amateur communication link(s) would be to supplement or replace links taken out by loss of POTS, Cellular, Internet, and/or the MARCs radio system after a major disaster or infrastructure upset.
- We are also limiting this presentation to the ranges and associated topography unique to Ohio.

In State Communication Techniques Overview

- Comparison of candidate Methods should be made using Metrics
- Each candidate method evaluated against several metrics:

(m) Description

1. Range - Ideal system would blanket the state border to border
2. Reliability - Ideal system would be 99% reliable and periodically verified.
3. Security - Ideal system would avoid the use of vulnerable sites .
4. Self Reliance - Ideal system would not rely on other links or infrastructure
5. Circuit Availability – The system should be available at least 99% 7x24 x 365 days a year.
6. Cost – The capital and maintenance expense should be low.
7. Complexity – KISS principle applies here.
8. Maturity of the technology – Demonstrated systems are lower risk.
9. Manpower and Training Requirements – System should fit into general ARES training objectives and not require specialized support.
10. Capacity and Bandwidth– Does method support adequate bandwidth and independent channels for the ARES requirement.

In State Communication Techniques Overview

- Possible Candidate Methods :
 - Tropo Scatter on microwave bands
 - Satellite Relay
 - 2.4 GHz or 5 GHz Mesh networks
 - 70 cm, 2, or 6 meter Simplex LOS SSB
 - Statewide FM Super 6 Meter Repeater in Columbus
 - VHF/UHF Repeater Linking including D-Star
 - 2 meter Packet - Using Digipeaters
 - LF (137 Khz) Ground Wave using slow digital rates.
 - HF Ground Wave
 - HF Skywave using NVIS Technology

Method Evaluated for this presentation

HF using NVIS
Skywave Propagation

Scoring per metrics against other methods
will be left to a later date.

HF using Ground Wave & NVIS Skywave Propagation

- Other methods have their merits, but this presentation will home in on HF bands

and take a new look at the pros and cons objectively so we can evaluate it fairly.

- We will take a new look at HF with the objective for in state communications and leave the DX uses aside.
- No approach is perfect, so understanding the limiting factors allows us to optimize the method.

Counties

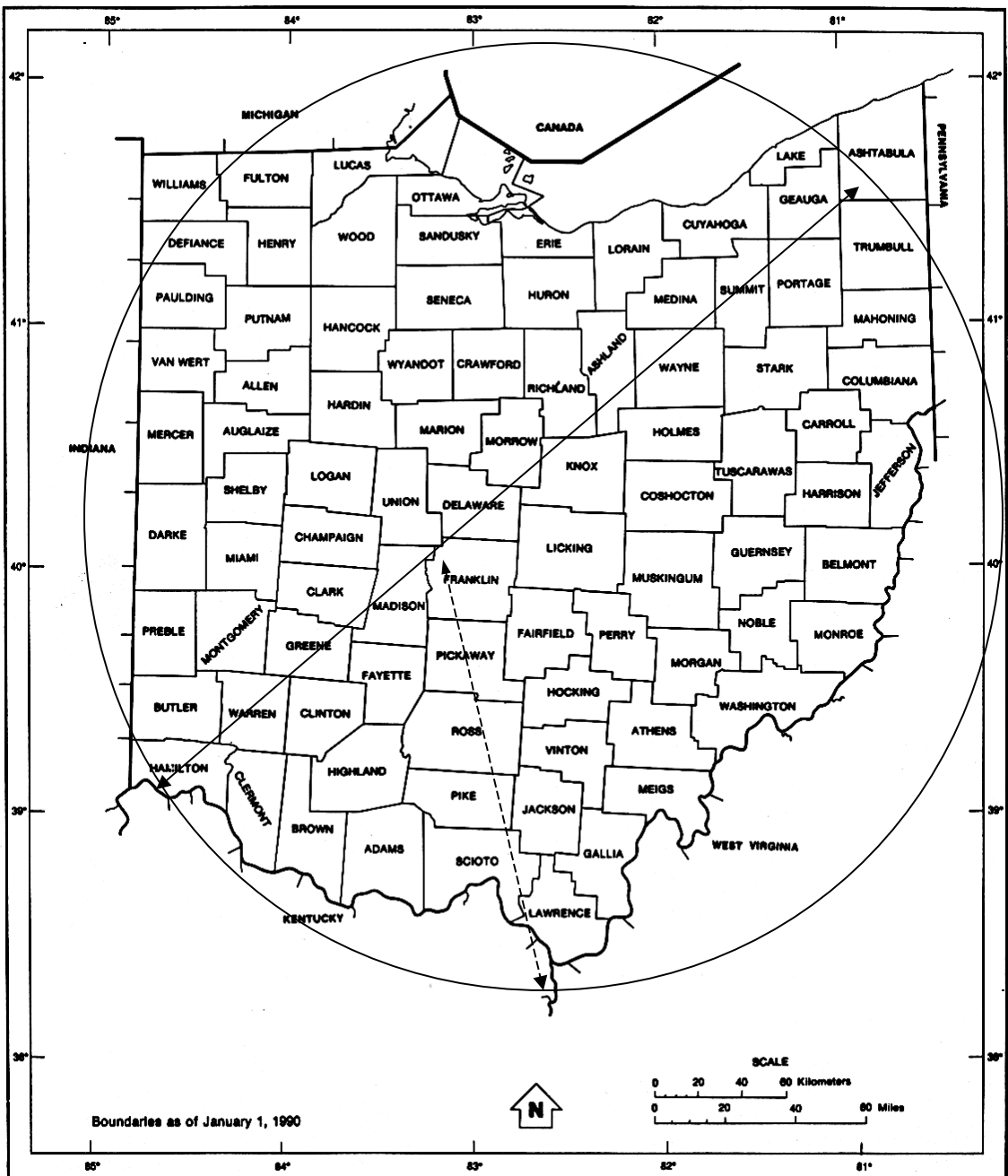

Geographic Facts
Driving Requirement:

Maximum Range
 ~ 240 miles Hamilton to Ashtabula County

Ohio EOC (NW Franklin County) to furthest County (Lawrence)
 ~145 miles

Approach should provide reliable communications at 0-150 miles minimum
 And 0-240 miles ideally.

Note; All distances are approximate interpolated from map.

HF using NVIS

Skywave Propagation

- Important note before we start:
- *“NVIS” is not just an antenna type or a propagation mode — it is a tactical communications system that was designed by military radio operators in the field. The NVIS antenna is only part of that system. The other part is the knowledge and cooperation of the operators, which must be accurately applied to achieve the best results — particularly when results are a life-and-death matter. Emergency communications should be driven by clearly written procedures that have been well-designed and tested. The procedures should be drilled on a regular schedule, and the drills should be followed by debriefings attended by everyone, so that all can learn to avoid mistakes. Suitable procedures are available in books, Field Manuals, and on the web. Look for ARES and RACES web sites and capture their procedural documents. Other excellent sources are FEMA and MARS sites.”*

Copyright © 2002-2011 by Harold Melton, KV5R.

- We are not there yet in Ohio. We have a lot of work to do.

HF using NVIS
Skywave Propagation

Many pieces to the NVIS Puzzle

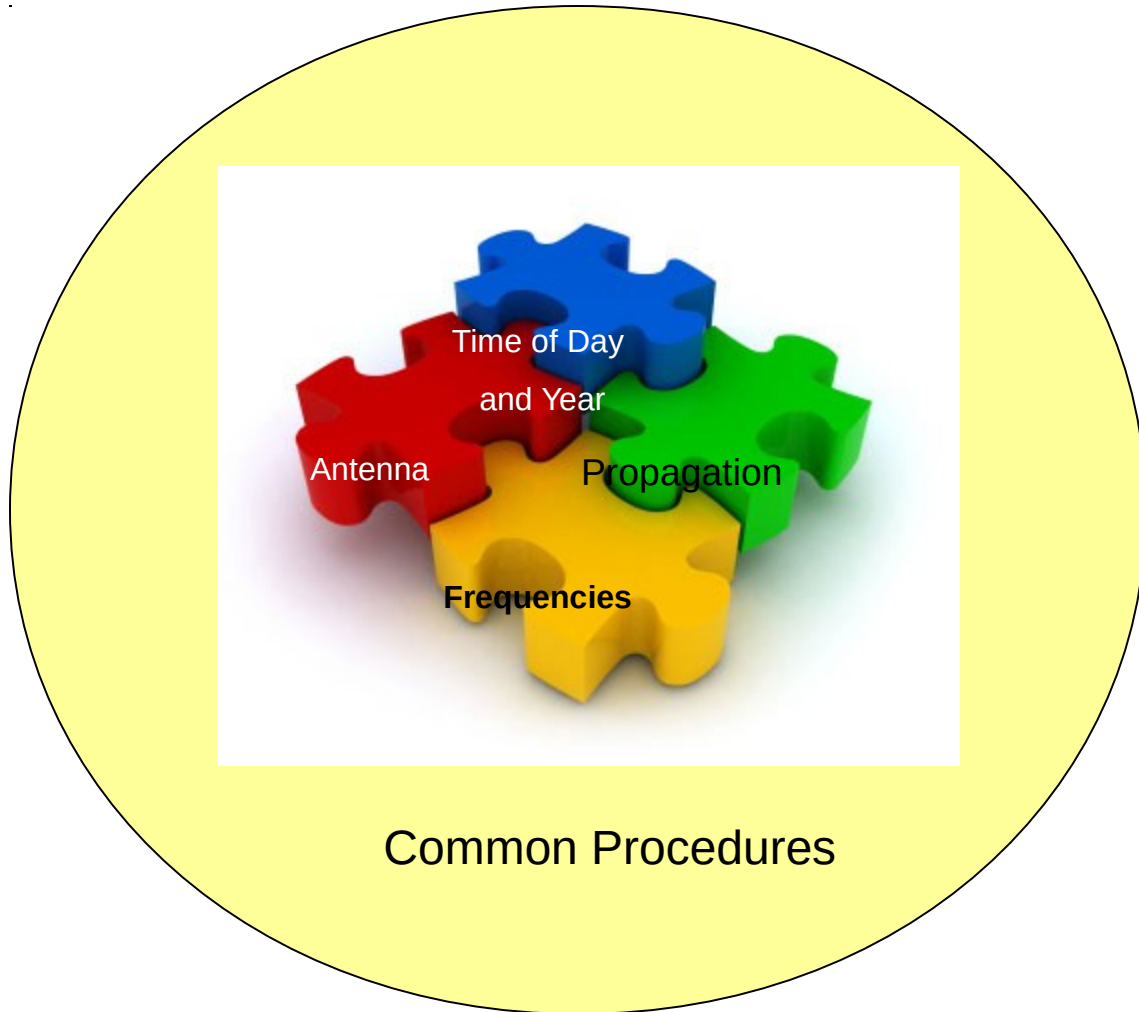



Common Procedures

HF using VIS Skywave Propagation

First

Let's take a look at how a HF signal frequency propagates over these ranges.

HF using VIS Skywave Propagation

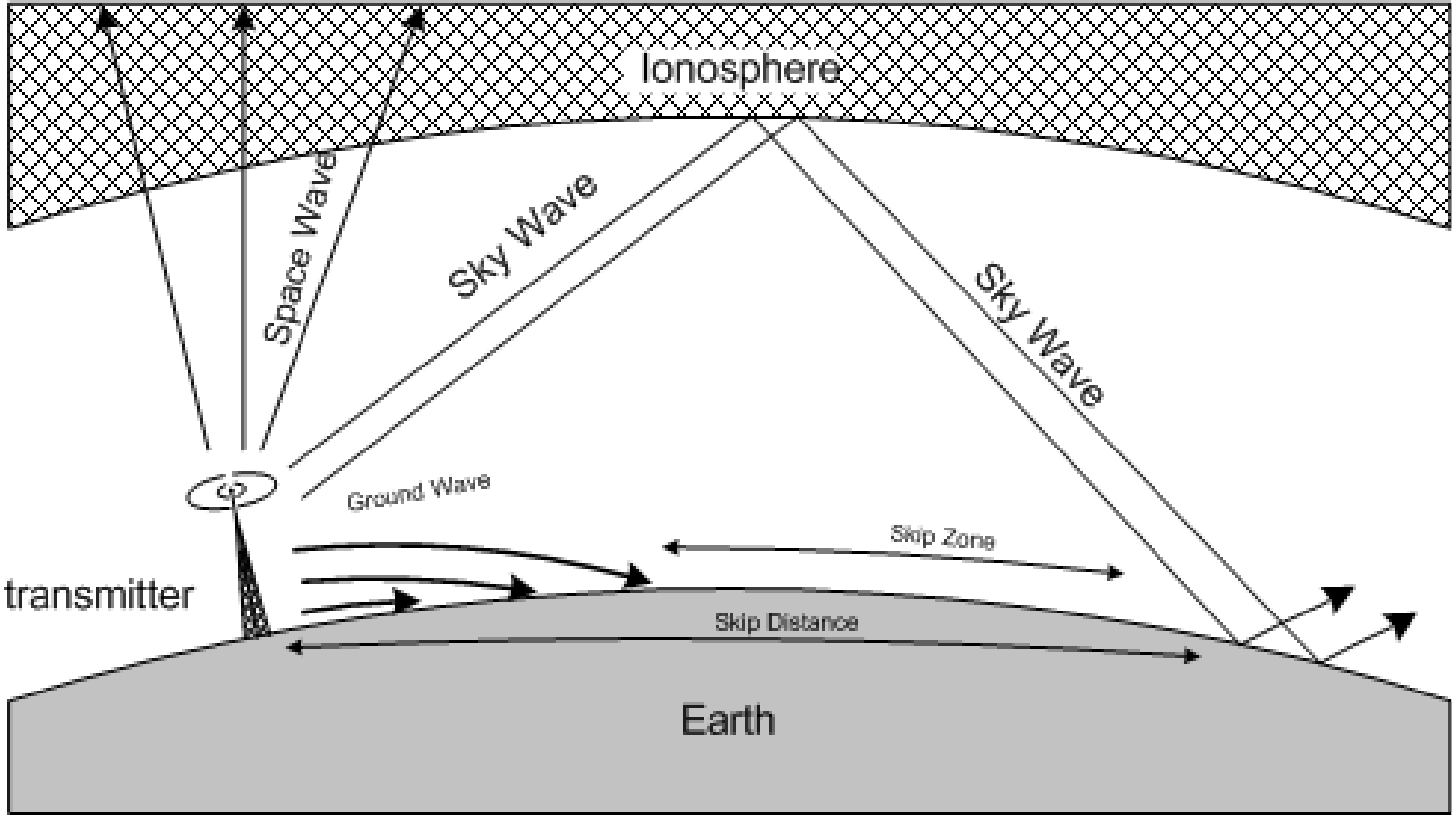

Ground Wave can be ruled out

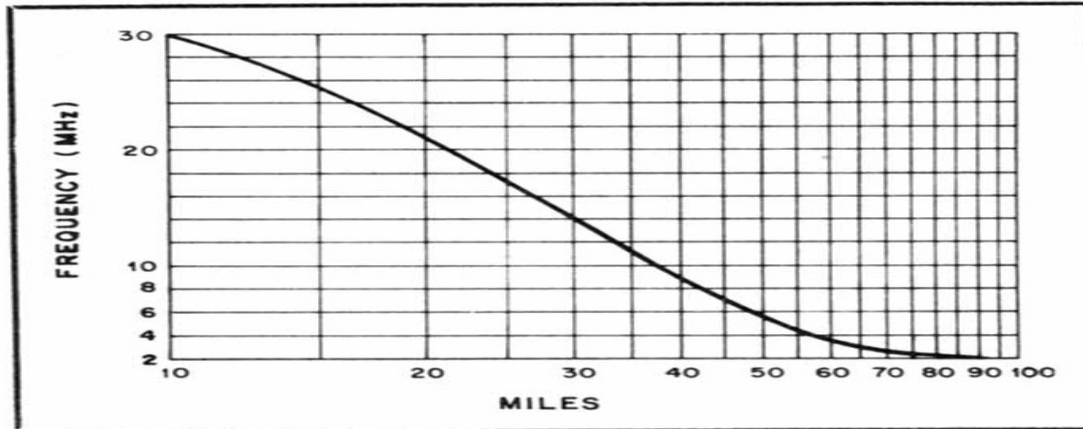
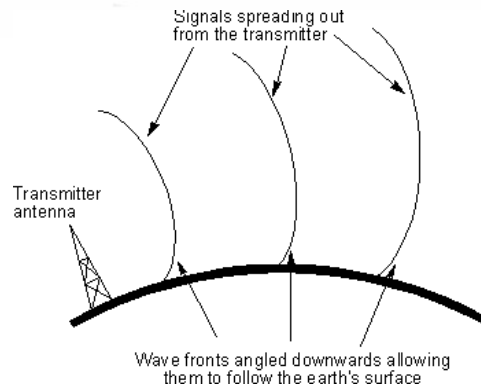

Fig. 1 — Typical high-frequency range, in miles, for ground waves compared to frequency. $\text{km} = \text{mi} \times 1.609$.



Many hams confuse ground wave with NVIS propagation. A strong ground wave signal can actually interfere with NVIS operation.

Line of Site could be used (almost)

- <http://www.hamuniverse.com/lineofsightcalculator.html> can be used to estimate Line of site distances with different variables.
- Many factors come into play on distances to count on for various stations. Here is one set of data from K4MSG for a 2 meter LOS SSB scenario with top of the line 2 meter amateur stations.

TABLE 3. 2 meter SSB Range In Miles @ 99% Reliability

	Antenna Gain and Height							
Antenna Gain	6 dB		9 dB		12 dB		15 dB	
Configuration	30'	60'	30'	60'	30'	60'	30'	60'
25W, No Preamp	63	80	75	100	93	215	175	272
80W With Preamp	80	130	100	245	215	280	272	310
160W With Preamp	90	200	160	268	252	295	285	325

- As we shall see later, both Ground Wave and LOS methods can fill in gaps when using NVIS

Antennas (signal launchers) are biggest factor

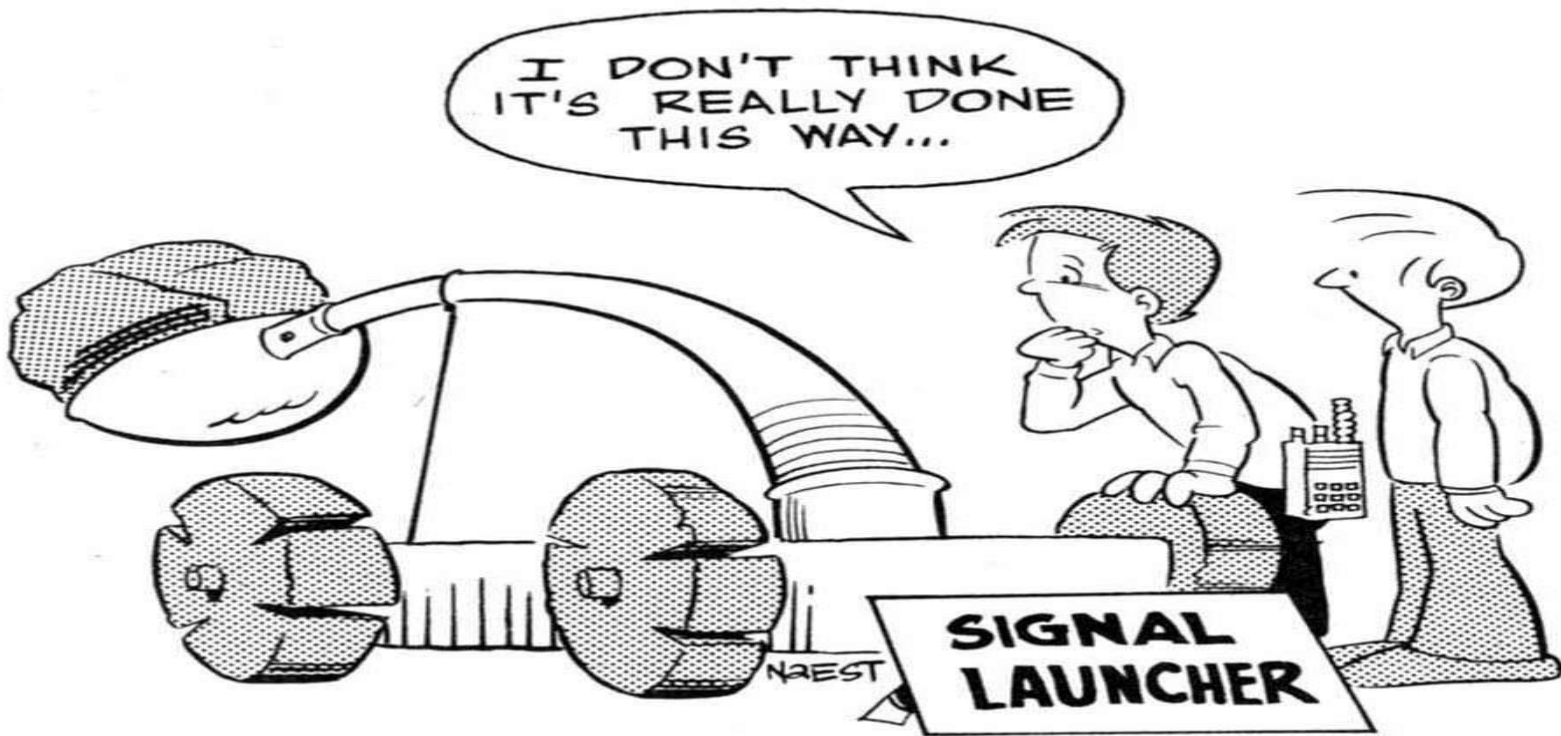

HF using NVIS

Skywave Propagation Antennas

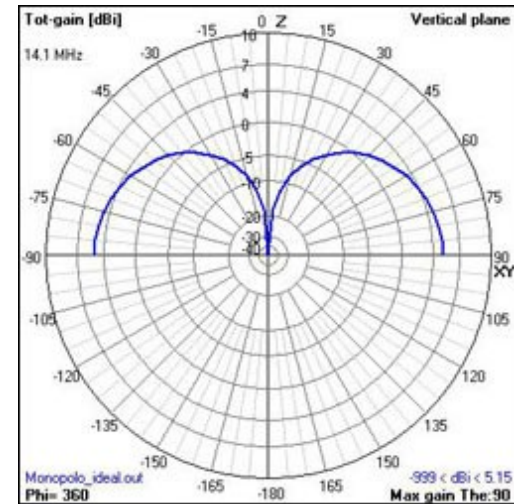
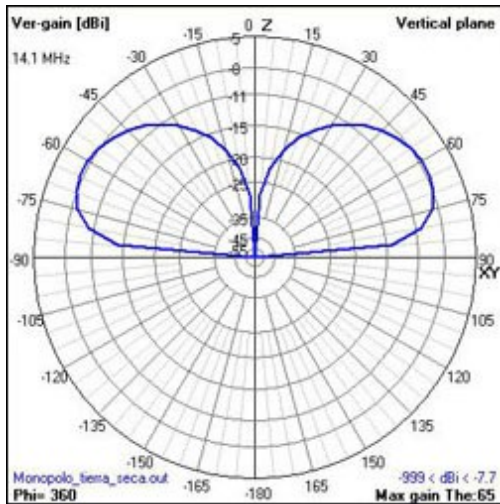

World's Worst NVIS Antenna
Guess what it is?

World's Next Worst NVIS Antenna
Guess what it is?

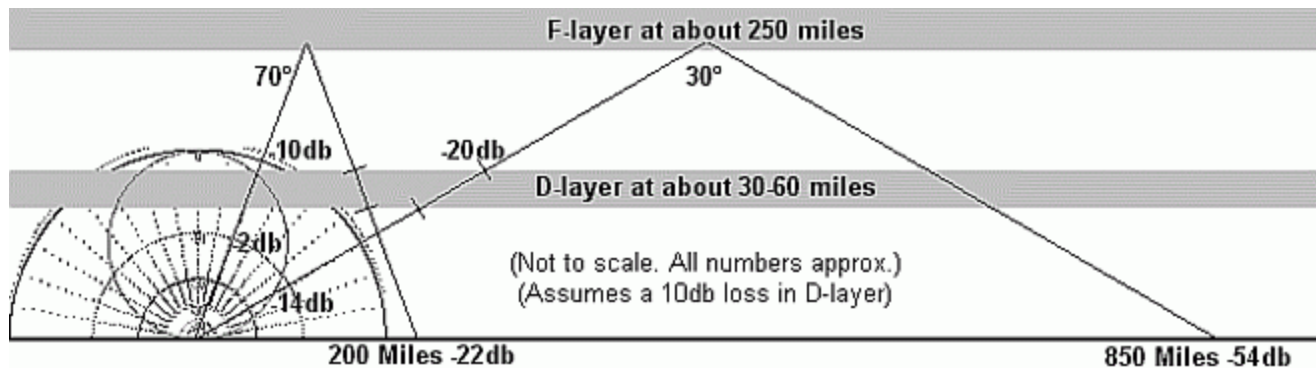

HF using NVIS Skywave Propagation Antennas

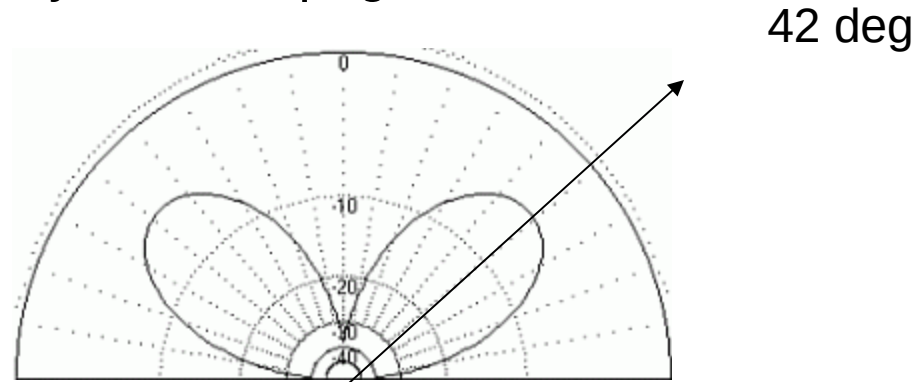

World's almost Worst NVIS

Vertical Axis Radiation Pattern of dipole at 120 ft. $\frac{1}{2}$ wave high
Ineffective for communications $>$ GW and $<$ skip zone.

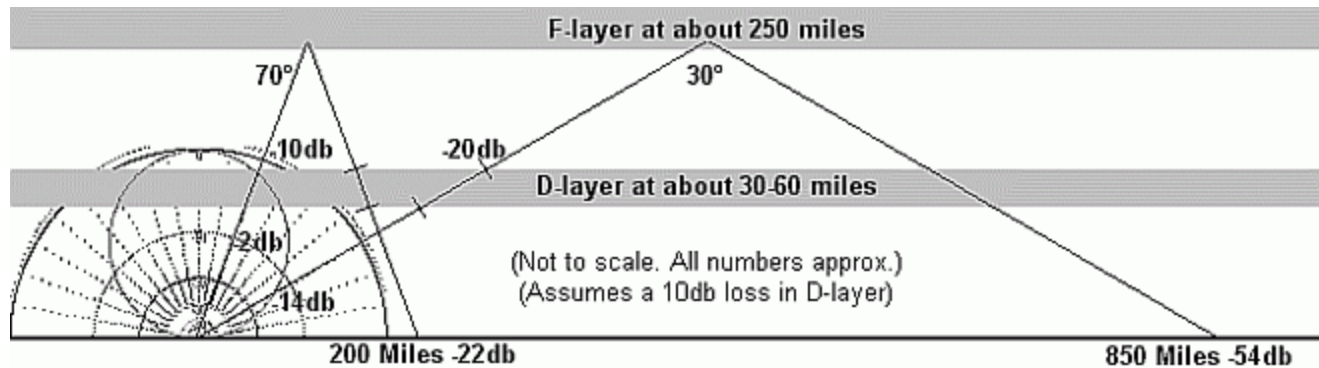

HF using NVIS

Skywave Propagation Antennas

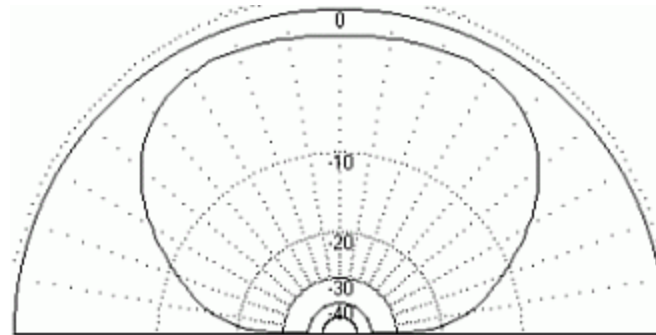

Vertical Axis Radiation Pattern of dipole at 90 ft. 3/8 wave
Ideal Height for NVIS 75 meter antenna

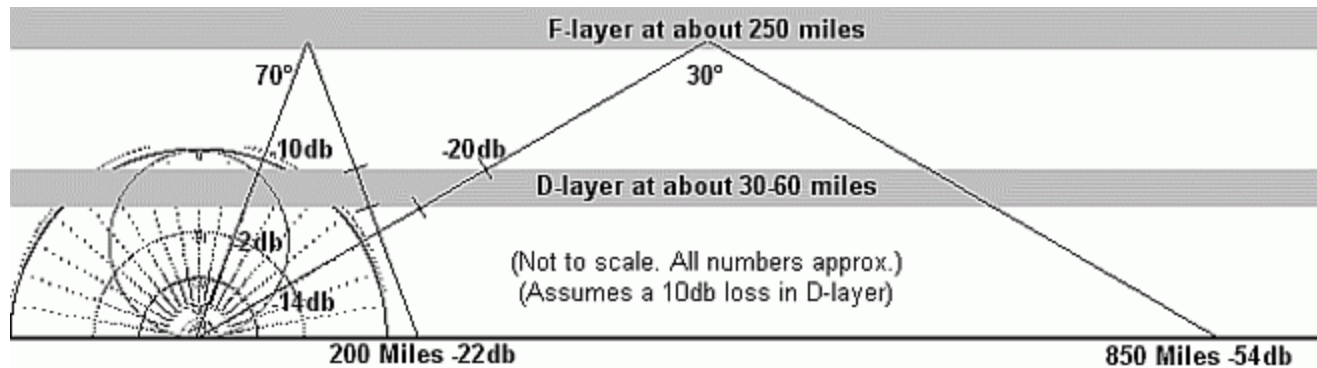

HF using NVIS Skywave Propagation Antennas

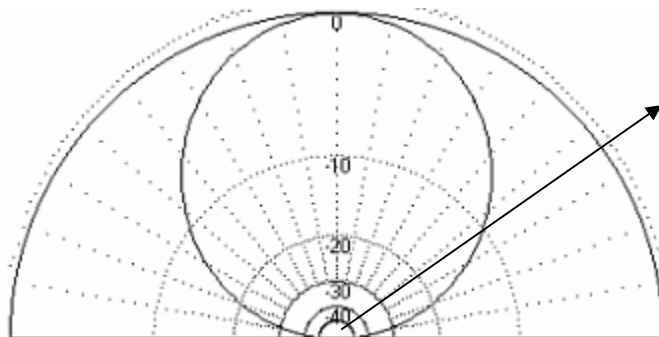

38 deg

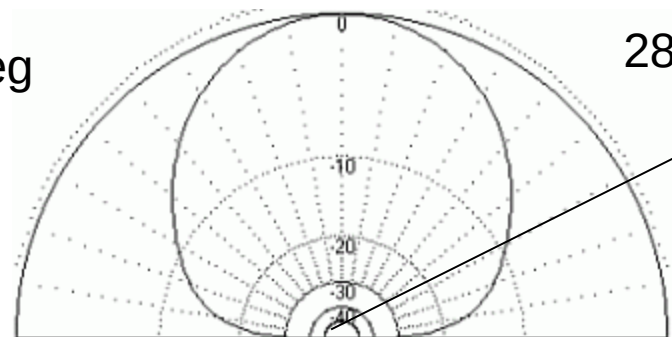

28 deg

Vertical Axis Radiation Patterns of 75 m dipole at 20 ft. $\frac{3}{8}$ wave
And 67 ft, $\frac{1}{4}$ wave

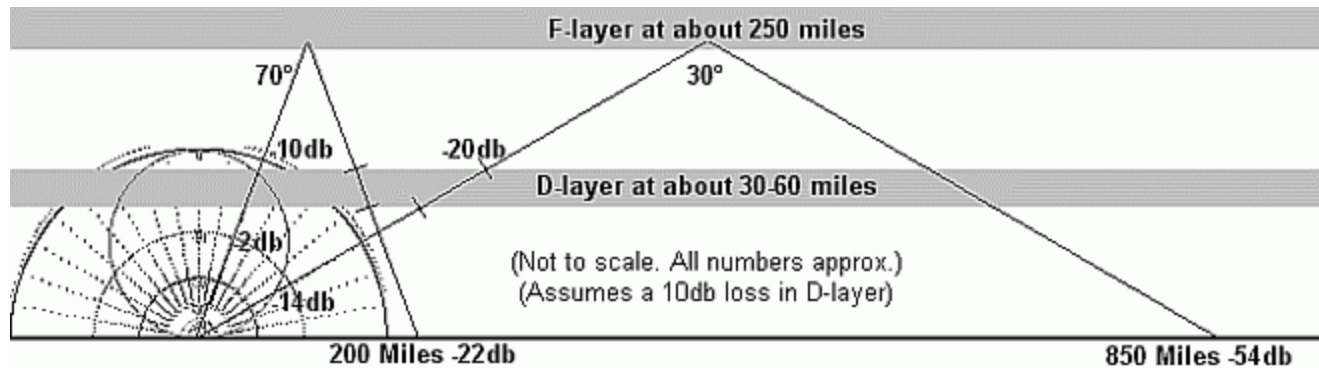

HF using NVIS

Skywave Propagation Antennas

Half Wave Dipoles at various HAT



$1/8\lambda$ high



$1/4\lambda$ high



$1/2\lambda$ high



$5/8\lambda$ high



$7/8\lambda$ high



1λ high



1.25λ high



1.5λ high



2λ high

HF using NVIS

Skywave Propagation Antennas

Raising the 75 meter NVIS antenna from 20 feet to 90 feet will add about 8db to the signal ray at 30 degrees, which is considerable, but usually not a sufficient justification for adding two 90-foot supports to the antenna farm. It would be ideal if W8SGT would install their antennas at this height.

The rule here is simple: If you want a reliable range of, say, 300 miles, use a real low antenna. If you want a little better morning/evening coverage, go to 90 feet as the optimum height. Raising the antenna from 20' to 90' simply gives you a little more power at lower angles (200-300 miles). Part of this extra power comes in part from the top of the lobe, and in part from reduced ground absorption.

Best vertical gain (about 7dbi) is achieved at .15 to .2 wave high, but the 20-foot high antenna will still have a gain of about 5.

The best possible 50 ohm SWR may be achieved at about 41 feet, over average ground although NVIS antennas should never be designed for minimum VSWR at 50 ohms..

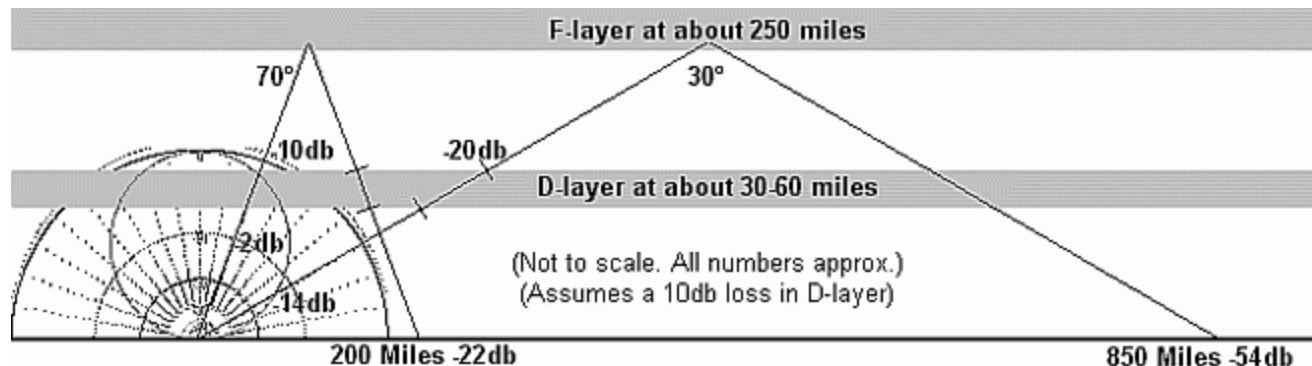

Real Data from Viet Nam era on optimum heights for NVIS antenna

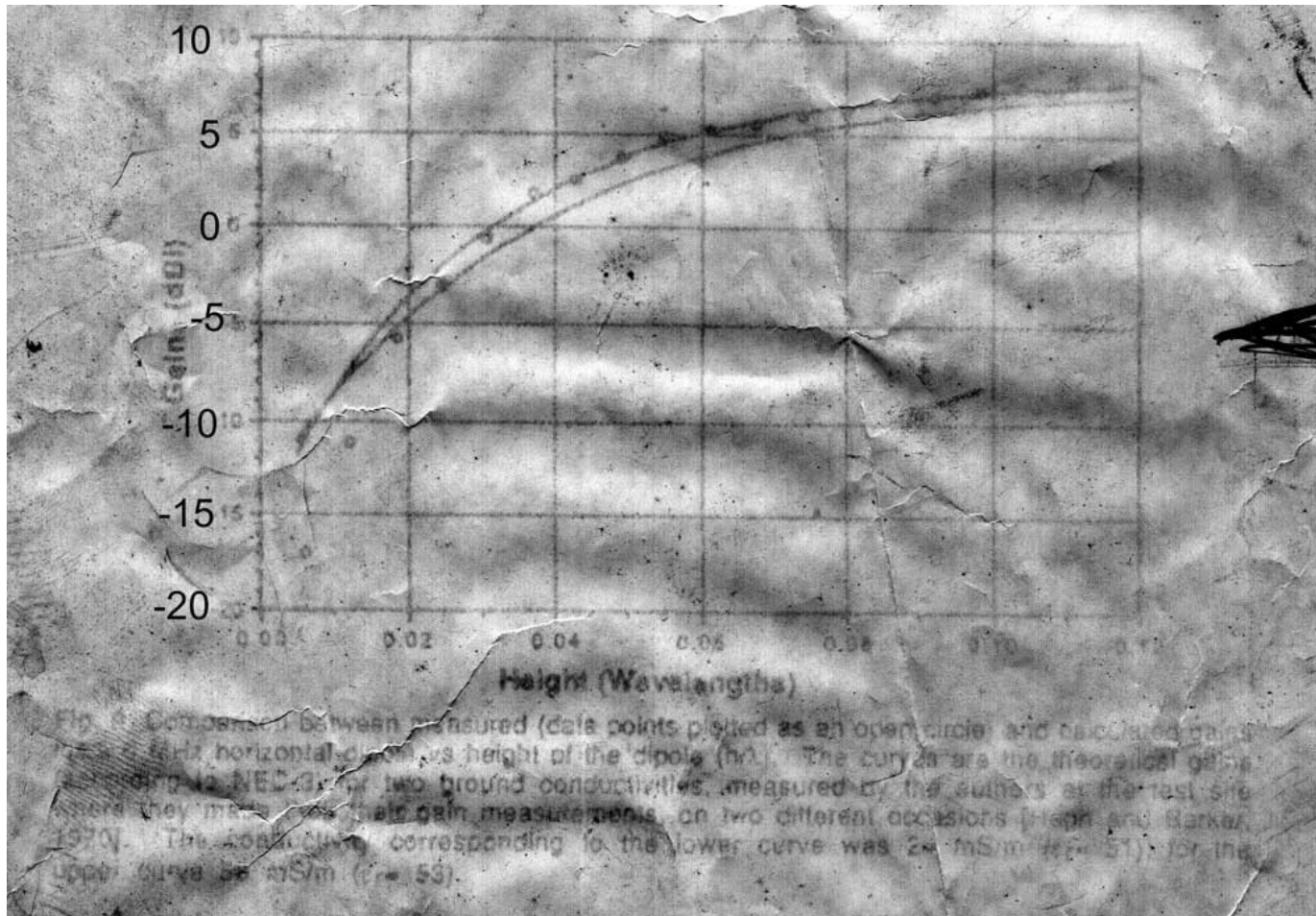

HF using NVIS

Skywave Propagation Antennas

Practical NVIS Antenna designs must not forget how the dipole height effects feed point impedance.

Meters	Feet	Ohms
4	13	8
6	20	15
8	26	25
10	32	35
12	40	46
14	46	57

If we mount our dipole at 20 feet as the previous slide recommends, we need to match 15 ohms not 50. Four 50 ohm coax cables in parallel or a high current ladder line is recommended together with a tuner at radio that can match 12 ohms.

HF using NVIS

Skywave Propagation Antennas

Some hams argue that a horizontal loop is the best NVIS antenna. The answer is yes and no.

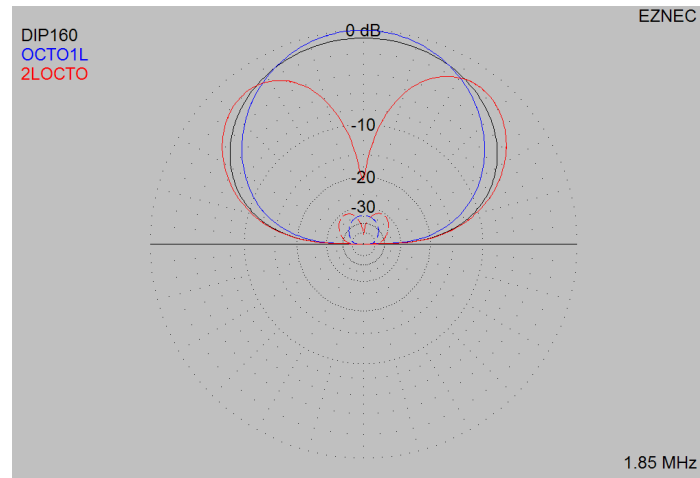

Beware when using horizontal Loops which are notoriously labeled sky warmers.

The black trace is at cut frequency 160 m

The red trace is 2nd harmonic i.e. 80 meters

There is no significant advantage over dipoles in using horizontal loops for NVIS and they

Should not be higher than $.2 \lambda$ at Highest Frequency used.

A half loop is the only effective Mobile NVIS Antenna and they require significant ground planes and tuning magic on vehicle.

ref ST940B

Folded back whips suffer from ground effects – They worked in Viet Nam jungles but not Iraq!!

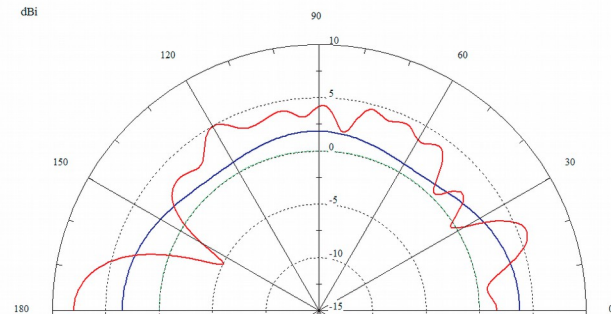
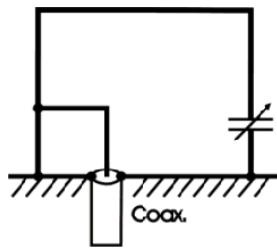

Commercial and Military Versions of the half loop !



Some Practical NVIS Antennas

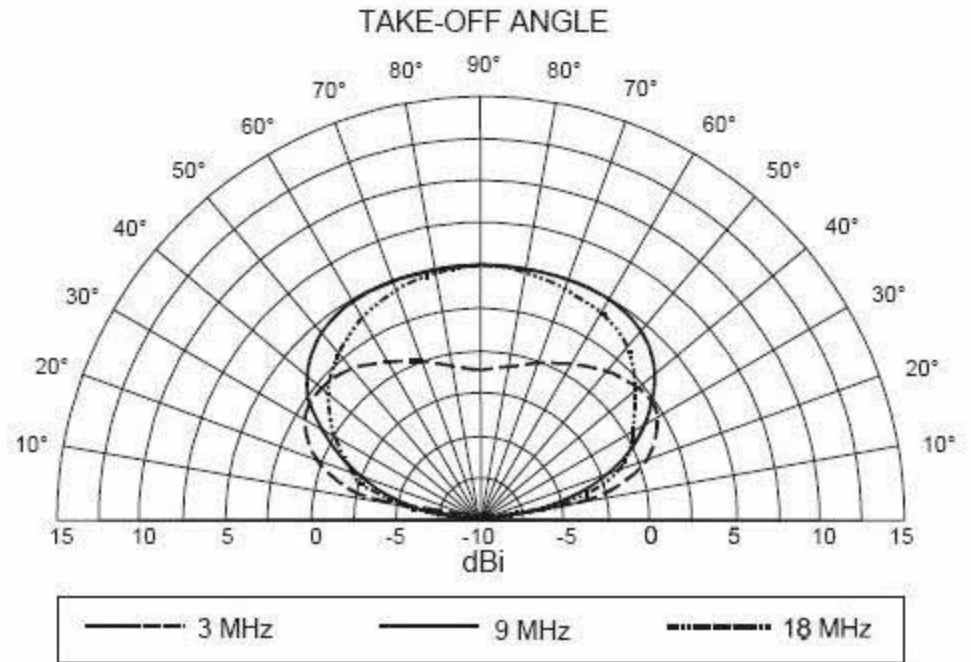

AS-2259 Vertical Radiation Pattern

This military surplus antenna can still be found at hamfests and E-bay.

Some Practical 80-40 M NVIS Antennas DX-Engineering

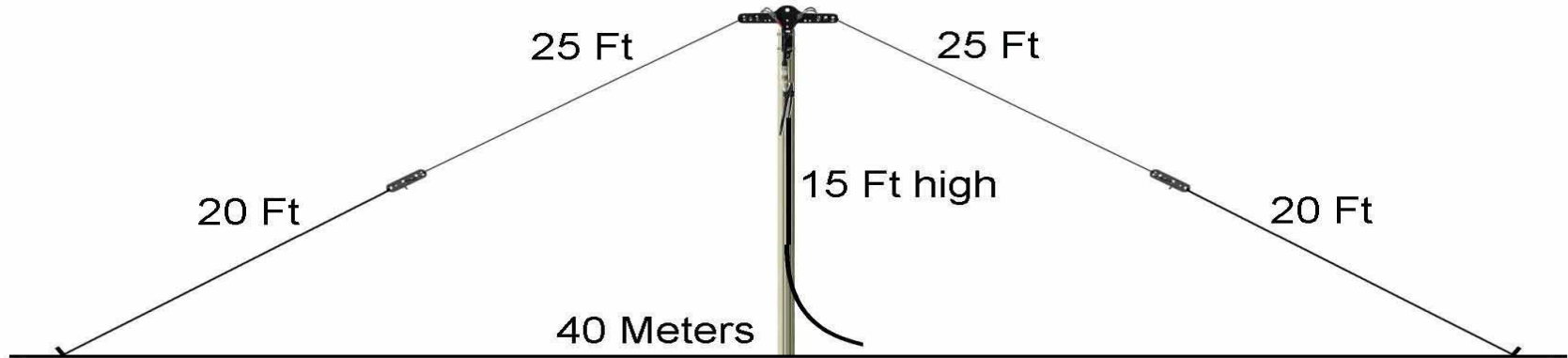

Side Views

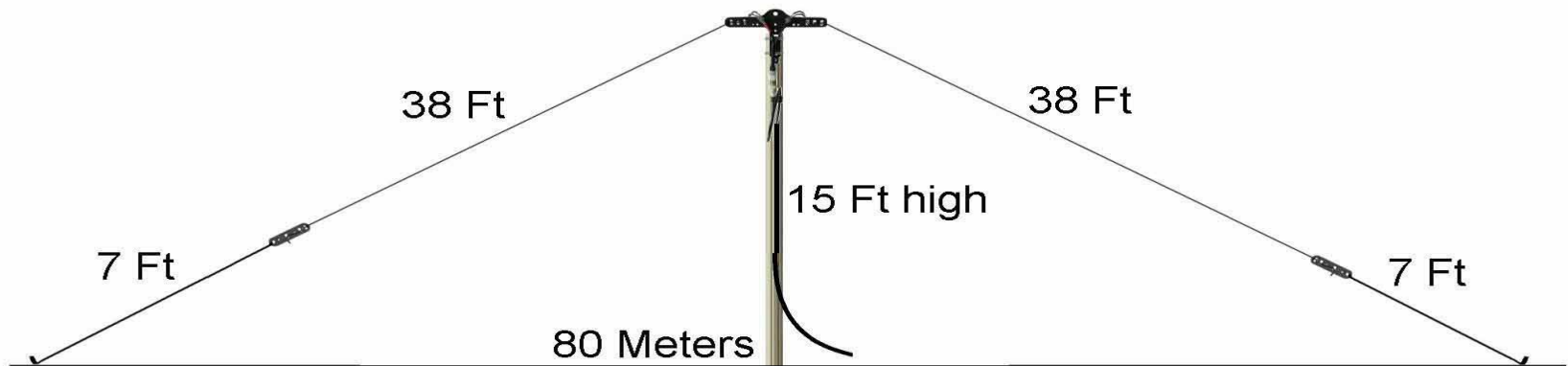

Some Practical 80-40 M NVIS Antennas DX-Engineering

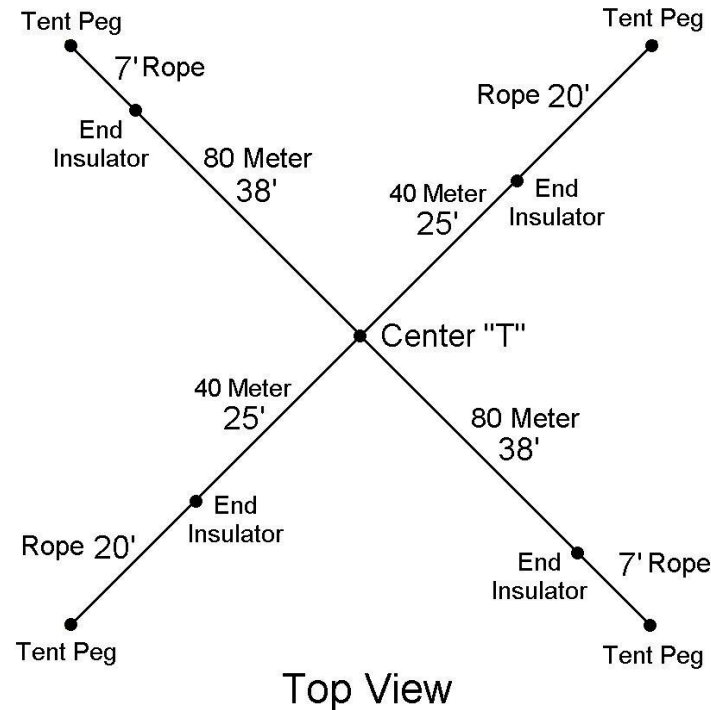

<http://static.dxengineering.com/pdf/WP-NVIS-Rev2.pdf>

Built with low cost Ohio parts.

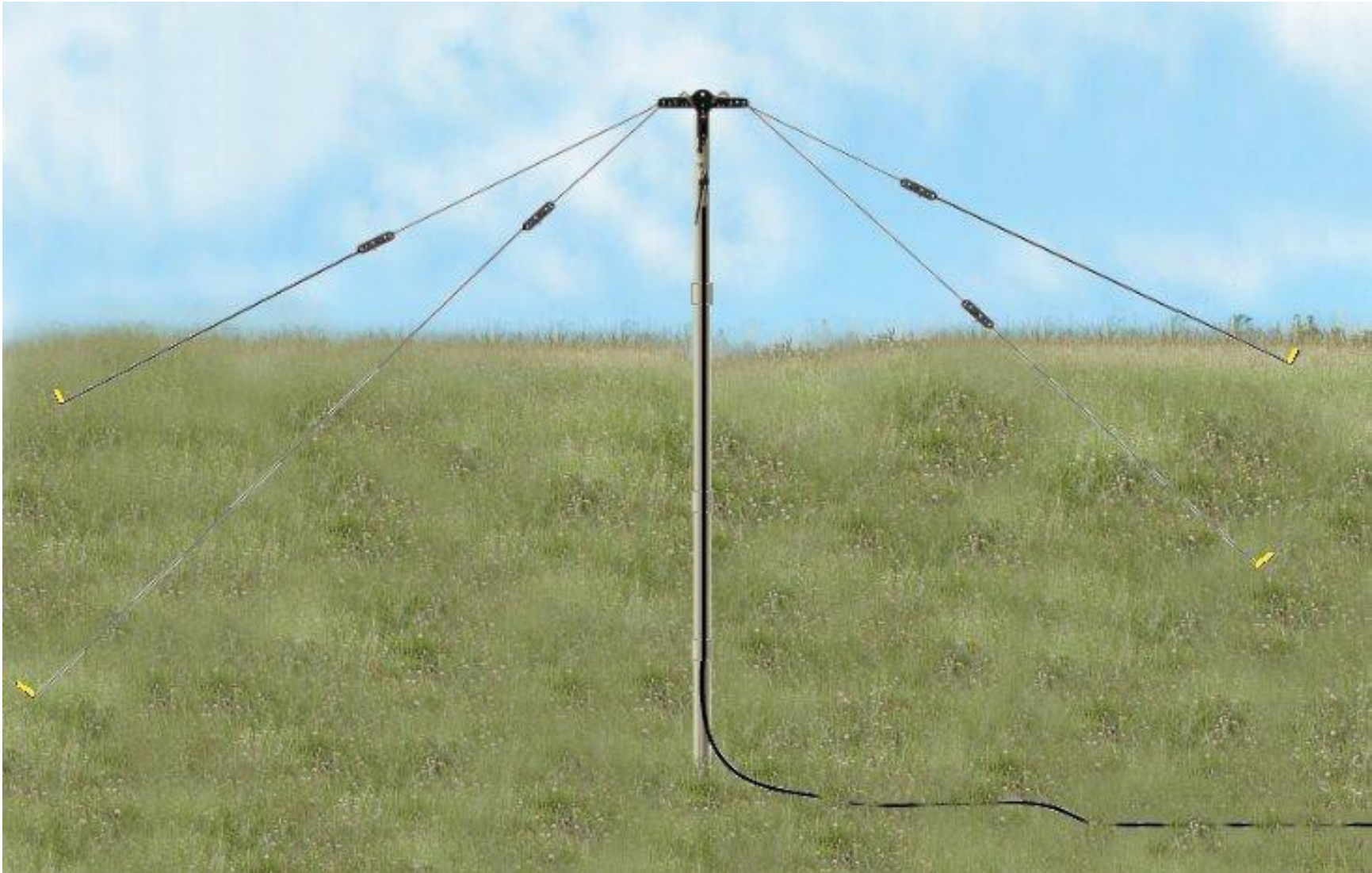

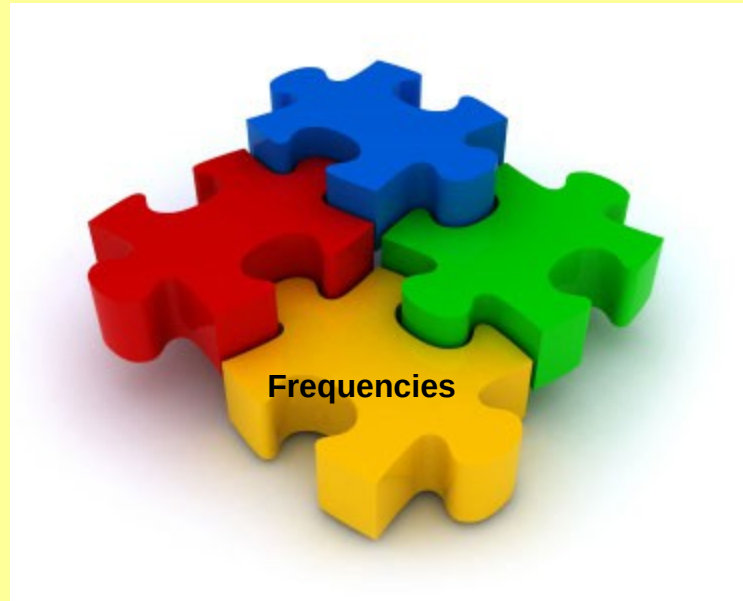

Common Procedures

The next piece of the puzzle is Frequency

- Optimal NVIS propagation is very frequency dependent.
- The best band (80% of f_oF_2) changes with season and time of day.
- There is always a lowest, optimum, and highest frequency for a given place, time and season, and solar activity.
- Radio waves directed vertically at frequencies higher than the critical frequency pass through the ionized layer out into space.
- Frequencies much lower than the critical frequency can experience excess attenuation in D layer and can also suffer from lightning and QRM from outside the skip zone..
- So what is this magic frequency and how do we coordinate a net to QSY as necessary to achieve best conditions?
- Over the past few years, I have seen folks beating their head trying to make 40 meters work for NVIS when the f_oF_2 is 6 MHz or below.
- The best NVIS system approach is to have 3 to 5 bands available and use a system such as ALE to select the optimum band up to 4 times per hour. At times 160 and 30 meters can provide alternatives.
- **160 m, 80m, 60m, 40m,** and 30 meters

f0F2 hourly Variations (Sept 2014)

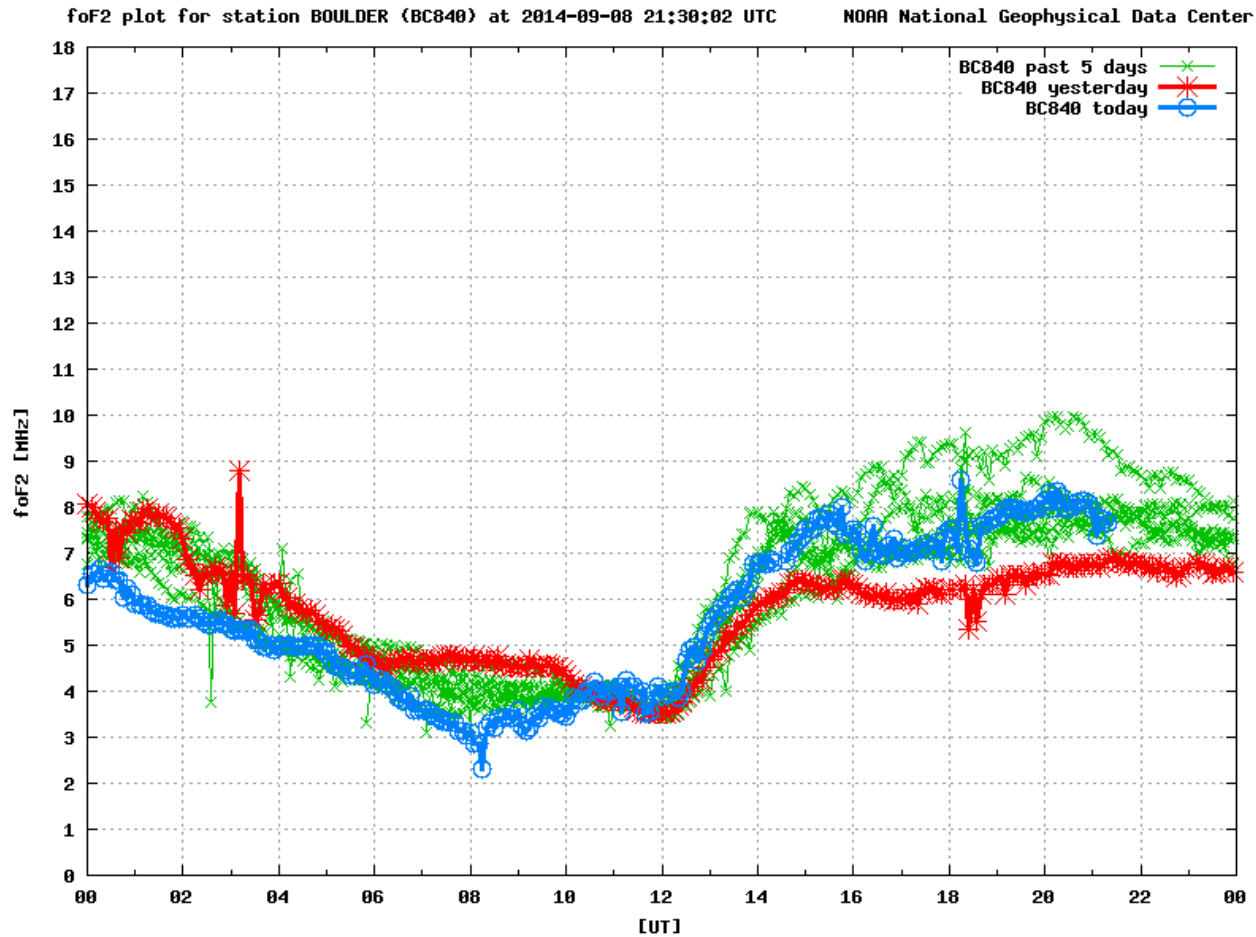

<http://www.hamqsl.com/solar3.html>

Global Real Time Ionospheric foF2 Map 13/09/14 Hour:02 UT

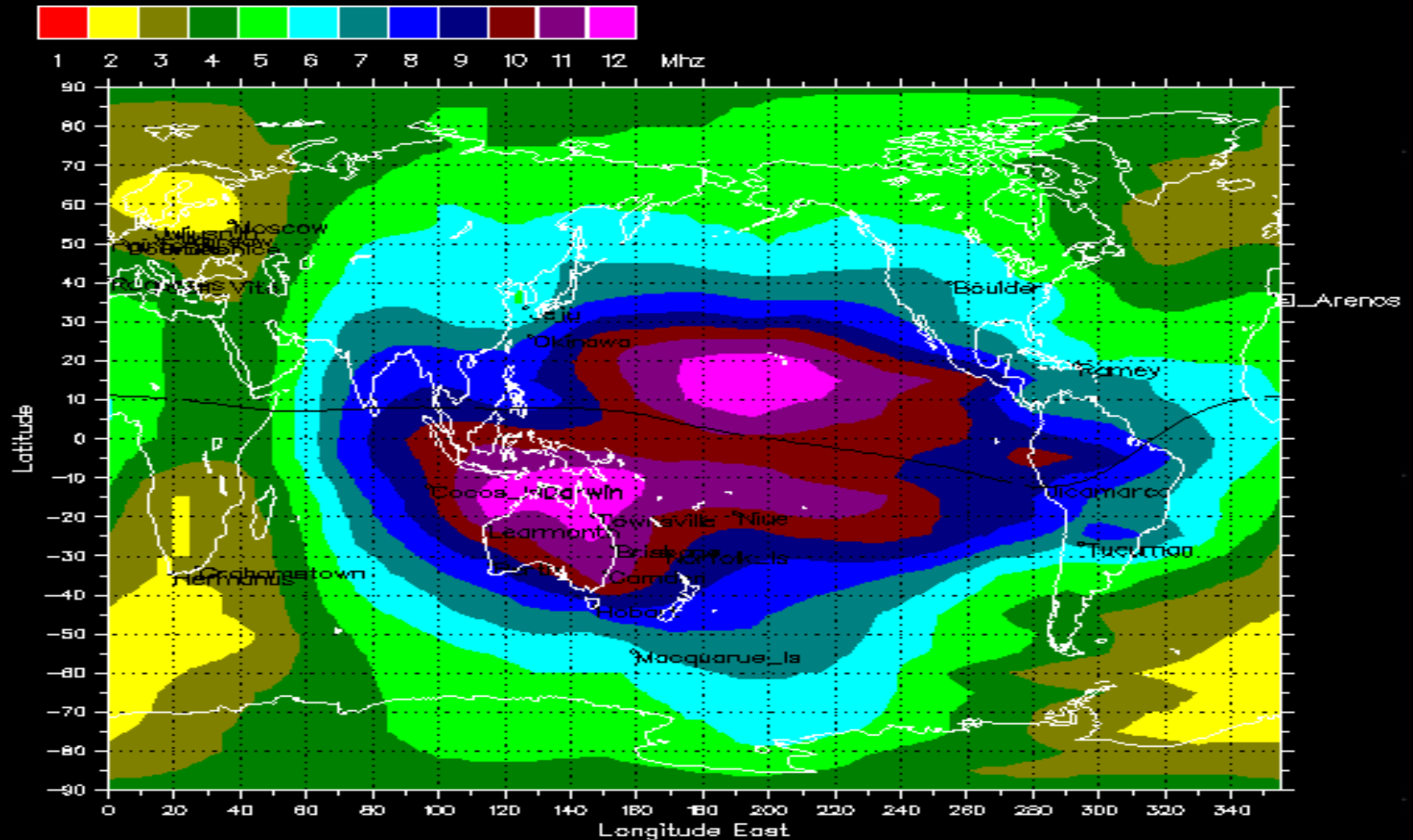

Created at 13/09/2014 03:06:36 UT

Current Global foF2 Frequency Map

Next factors are Time, Date, and Propagation

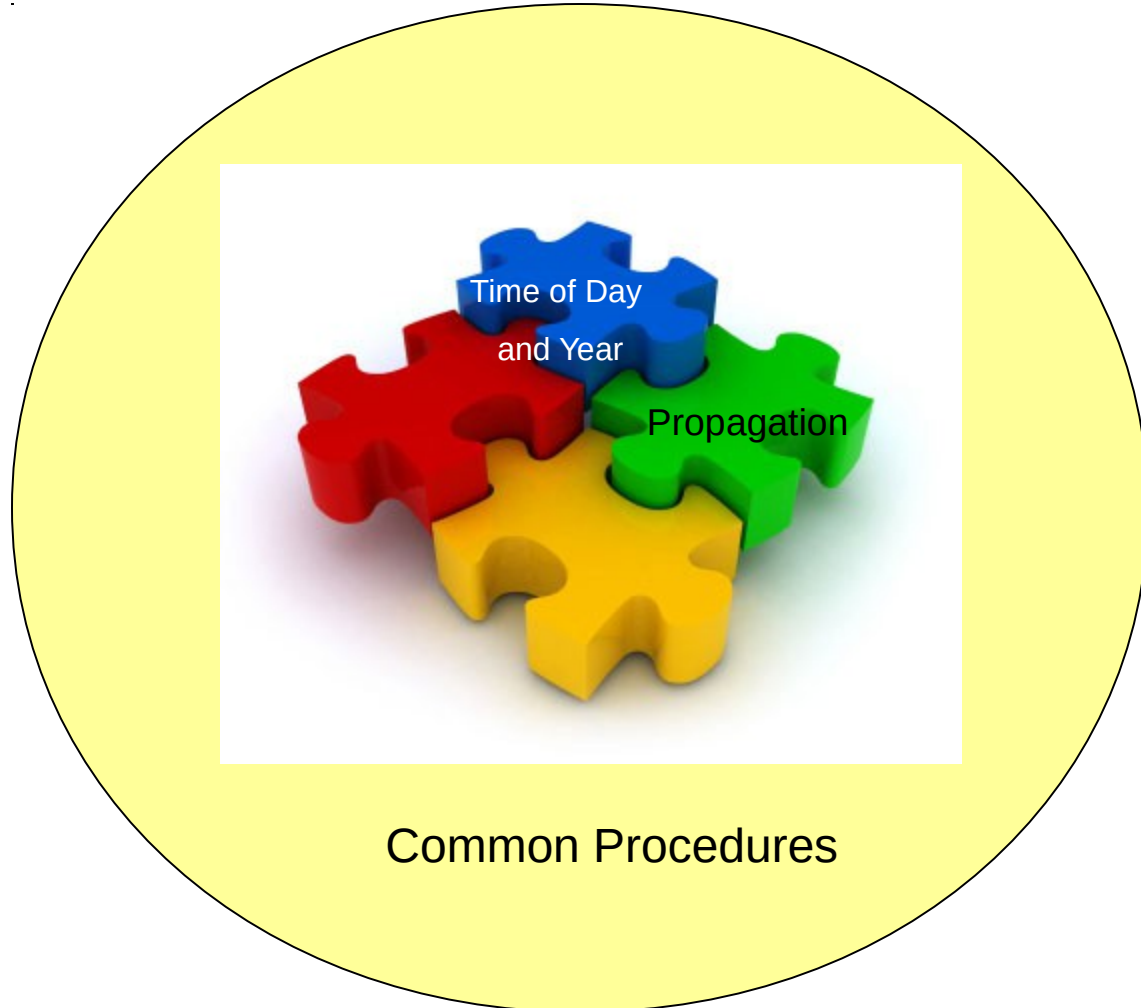

Band Selection for NVIS

- **Periods of high solar activity**
 - Daytime - 60, 40 and 30 m
 - Nighttime – 60 and 80 m
- **Periods of low solar activity**
 - Daytime - 80, 60 or 40m
 - Nighttime - 80 or 160 m

Why critical frequency varies

How NVIS works

- In order for the NVIS signal to be returned to the earth's surface, its frequency must be less than the critical frequency of the F-layer
- During daytime, the critical frequency is approximately 5 to 15 MHz. After sunset, the critical frequency drops throughout the night, reaching a low of 1 to 5 MHz just before dawn.
- It is desirable to use frequencies just below the critical frequency to minimize signal absorption by the D-layer

Note: f_0F_2 is not MUF (Maximum usable frequency)

Summary

- Of all the candidate methods, NVIS has the most potential. Scoring metrics comparing it to other approaches is TBD. It is also very challenging in a ham community when conformance to strict rules is required.
- A NVIS net requires a dedicated team with written procedures all marching to same drummer.
- This paradigm does not always describe a ham or ARES network.
- Success requires a careful plan and one which regularly re-calibrates and verifies the assumptions made in baseline design.
- On the air experience with continuous process improvement is best teacher.
- Participation in 40 and 80 meter nets will hone your understanding of NVIS principles to squeeze out those last few dBs of S/N improvement. Keep track of the distances and signal reports you receive and give to in state stations in your log. Ask other stations what kind of antenna they are using.
- Have fun and participate in exercises as OSPOTA and Ohio QSO party to test your NVIS station.
- There is a wealth of information out on the web. This presentation only scratches the surface.