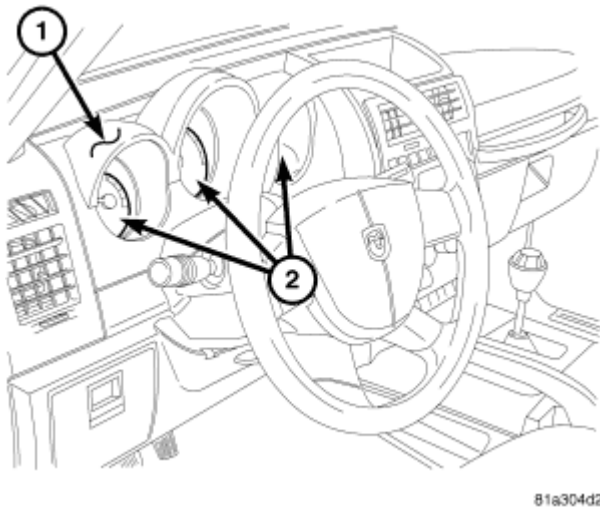

2007 ACCESSORIES AND EQUIPMENT**Instrument Cluster - Service Information - Nitro****INSTRUMENT CLUSTER****DESCRIPTION****INSTRUMENT CLUSTER**

81a304d2

Fig. 1: Identifying Cluster Bezel & Instrument Cluster
Courtesy of CHRYSLER LLC

The instrument cluster (2) for this vehicle is an Electro Mechanical Instrument Cluster (EMIC) that is located in the instrument panel above the steering column opening, directly in front of the driver. The remainder of the EMIC, including the mounts and the electrical connections, are concealed within the instrument panel below the cluster bezel (1). The instrument cluster for this vehicle also includes the hardware and software necessary to serve as the electronic body control module and is sometimes referred to as the Cab Compartment Node or CCN.

Besides analog gauges and indicators, the EMIC module incorporates one standard blue-green digital Vacuum Fluorescent Display (VFD) unit. A second optional VFD unit is available in some vehicles. The standard VFD is a fixed segment unit for displaying odometer information, automatic transmission gear selector position (PRNDL), and several other indicators. The optional compass/temperature VFD unit is a large fixed segment display. The optional Electronic Vehicle Information Center (EVIC) VFD unit is a large reconfigurable display unit. These optional VFD units serve as the visual display for the compass, the outside temperature, the trip computer, the audio system settings as well as the user interface for the customer programmable features, numerous textual warning or reminder indicators and certain diagnostic information depending upon vehicle equipment.

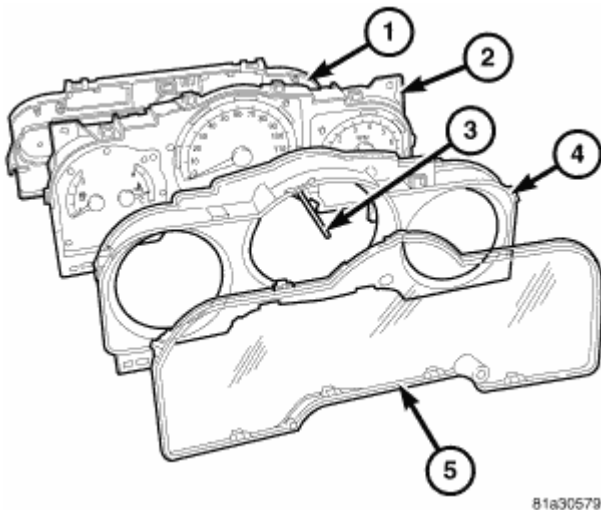

81a30579

Fig. 2: Identifying Plastic Rear Cover, Cluster Housing, Plastic Cluster Lens & Mask Unit
 Courtesy of CHRYSLER LLC

The EMIC gauges and indicators are visible through three dedicated openings in the cluster bezel and are protected by a clear plastic cluster lens (5). Nine integral latch formations on the lens secure it to the cluster hood and mask unit (4) as well as the cluster housing (2). Just behind the cluster lens is the cluster hood and integral mask, which is constructed of molded black plastic. The hood serves as a visor and shields the face of the cluster from ambient light and reflections to reduce glare, while the cluster mask serves to separate and define the individual gauges and trims the outside perimeter of the cluster overlay. The hood and mask unit has eight integral latch features that secure it to the outer perimeter of the cluster housing. The hood and mask unit also has two integral mounting tabs on the lower corners that combine with the tabs integral to the cluster housing to secure the bottom of the EMIC to the molded plastic instrument panel cluster carrier with two screws.

The rear of the cluster housing and the EMIC electronic circuitry are protected by a molded white plastic rear cover (1), which is also secured to the cluster housing by integral latch features. The rear cover includes clearance holes for the four cluster connector receptacles. The connector receptacles on the back of the cluster electronic circuit board connect the EMIC to the vehicle electrical system through four take outs with connectors from the instrument panel wire harness.

Sandwiched between the rear cover and the lens and hood unit is the cluster housing. The molded white plastic cluster housing serves as the carrier for the cluster circuit board and circuitry, the cluster connector receptacles, the two major and two minor gauges, a Light Emitting Diode (LED) for each cluster indicator, the VFD display units, an audible tone transducer, several LED units for general cluster illumination, the cluster overlay, and the gauge pointers. The standard equipment molded black plastic odometer/trip odometer switch button (3) extends from the face of the cluster housing through dedicated holes in the cluster mask and the cluster lens adjacent to their respective VFD units. A black rubber grommet seals the switch button to the clearance hole in the lens. The cluster housing also has four integral mounting tabs, one on each upper and lower corner of the housing.

The cluster overlay is a laminated plastic unit. The dark, visible, outer surface of the overlay is marked with all of the gauge dial faces and graduations, but this layer is also translucent. The darkness of this outer layer prevents the cluster from appearing cluttered or busy by concealing the cluster indicators that are not illuminated, while the translucence of this layer allows those indicators and icons that are illuminated to be

readily visible. The underlying layer of the overlay is opaque and allows light from the LED for each of the various indicators and illumination lamps behind it to be visible through the outer layer of the overlay through predetermined stencil-like cutouts. Openings in the overlay at the base of the tachometer and the minor gauge set dial faces have smoked clear lenses through which the illuminated VFD units can be viewed.

Several versions of the EMIC module are offered on this vehicle. These versions accommodate all of the variations of optional equipment and regulatory requirements for the various markets in which the vehicle is offered. The microprocessor-based EMIC utilizes integrated circuitry and information carried on the Controller Area Network (CAN) data bus and the Local Interface Network (LIN) data bus along with several hard wired analog and multiplexed inputs to monitor sensors and switches throughout the vehicle. In response to those inputs, the internal circuitry and programming of the EMIC allow it to control and integrate many electronic functions and features of the vehicle through both hard wired outputs and the transmission of electronic message outputs to other electronic modules in the vehicle over the CAN and LIN data busses. Refer to **DESCRIPTION** .

Besides typical instrument cluster gauge and indicator support, the electronic functions and features that the EMIC supports or controls include the following:

- **Audible Warnings** - The EMIC electronic circuit board is equipped with an audible tone transducer and programming that allows it to provide various audible alerts to the vehicle operator. These alerts include single chime tones and continuous slow or fast tones. An electromechanical relay is also soldered onto the circuit board to produce audible clicks that are used to emulate the sound of a conventional turn signal or hazard warning flasher.
- **Compass/Temperature Display Support** - The EMIC provides support for each of the functions and features of the compass/temperature display, as well as for the odometer push button switch, which also provides user inputs to control the compass/temperature display options.
- **Electronic Vehicle Information Center Display Support** - The EMIC provides support for each of the functions and features of the Electronic Vehicle Information Center (EVIC) display. This includes support for the compass, thermometer and audio system mode, customer programmable features, textual warnings, premium Tire Pressure Monitor (TPM), trip computer, U-Connect™ Hands-Free communication and the switch inputs from the two EVIC rocker switches located on the front surface of the steering wheel spokes that are used to control and configure many of the displays. This also includes display arbitrator programming, which controls the priorities, sequences, and transition of information that is displayed in the EVIC display, particularly when multiple display requests are received simultaneously.
- **Enhanced Accident Response Support** - The EMIC monitors inputs from the Occupant Restraint Controller (ORC) and the Powertrain Control Module (PCM) to automatically turn ON the interior lighting after an airbag deployment event, 10 seconds after the vehicle speed is zero. The interior lighting remains illuminated until the key is removed from the ignition switch lock cylinder, at which time the interior lighting returns to normal operation and control. These Enhanced Accident Response System (EARS) features are each dependent upon a functional vehicle electrical system following the vehicle impact event.
- **Exterior Lighting Switch Support** - The EMIC monitors electronic **exterior lighting switch** , and **turn signal switch status** messages from the Steering Control Module (SCM) on the steering column over the LIN data bus and transmits the appropriate electronic **exterior lighting** and **turn signal request** messages to the Totally Integrated Power Module (TIPM) over the CAN data bus to support the exterior lighting

functions.

- **Horn Switch Support** - On vehicles without the optional EVIC, the EMIC receives a hard wired input from the horn switch on the steering wheel. On vehicles with the optional EVIC, the EMIC receives electronic **horn switch status** messages from the Steering Wheel Switch Module (SWSM) over the LIN bus. In either case, the EMIC then provides electronic **horn request** messages over the CAN data bus to support the horn function.
- **Interior Lamp Load Shedding** - The EMIC provides a battery saver feature which will automatically turn OFF all interior lamps if they remain ON after a timed interval of about ten minutes.
- **Interior Lighting Control** - The EMIC monitors electronic messages and hard wired inputs from the reading lamp switches, the Sentry Key REmote Entry Module (SKREEM) (also known as the Wireless Control Module/WCM), the Steering Control Module (SCM) and the Totally Integrated Power Module (TIPM) to provide courtesy lamp control. This includes support for timed illuminated entry with theater-style fade-to-OFF and courtesy illumination DEFEAT features.
- **Local Interface Network Master Module** - The EMIC is the master module for the LIN data bus. In this role it gathers information from the compass sensor, the Heated Seat Module (HSM), the instrument panel switch pod, the Steering Wheel Switch Module (SWSM), the SCM and the remote compass module, then either acts on that information directly or places electronic messages on the CAN data bus for use by other modules
- **Panel Lamps Dimming Control** - The EMIC monitors electronic **dimming level** messages received from the panel lamps dimmer switch input to the SCM over the LIN data bus, then provides both a hard wired 12-volt Pulse-Width Modulated (PWM) output and electronic message outputs over the CAN data bus and the LIN data bus that synchronizes the dimming level of all panel lamps dimmer controlled lamps with that of the cluster general illumination lighting.
- **Wiper and Washer Switch Support** - The EMIC monitors electronic **wiper switch** and **washer switch status** messages from the SCM on the steering column over the LIN data bus and transmits the appropriate electronic **wiper** and **washer request** messages to the TIPM over the CAN data bus to support the wiper and washer system functions, including the headlamps-on with wipers programmable feature.

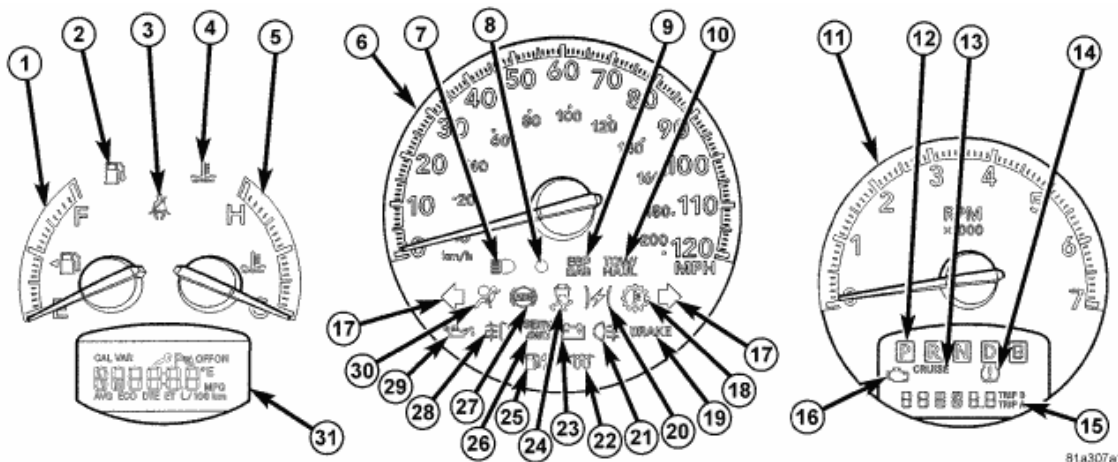

Fig. 3: Analog Gauge Indicators
 Courtesy of CHRYSLER LLC

The EMIC houses four analog gauges and has provisions for up to 25 indicators. Some of the EMIC indicators

2007 Dodge Nitro R/T

2007 ACCESSORIES AND EQUIPMENT Instrument Cluster - Service Information - Nitro

are automatically configured when the EMIC is connected to the vehicle electrical system for compatibility with certain optional equipment or equipment required for regulatory purposes in certain markets. While each EMIC may have provisions for indicators to support every available option, the configurable indicators will not be functional in a vehicle that does not have the equipment that an indicator supports.

The EMIC includes the following analog gauges:

- **Engine Temperature Gauge (5)**
- **Fuel Gauge (1)**
- **Speedometer (6)**
- **Tachometer (11)**

The EMIC includes the following VFD display units:

- **Odometer Display (15)** - includes Cruise indicator (13), Gear Selector indicator (12), Malfunction Indicator Lamp (MIL) (16) and Tire Pressure Monitor (TPM) indicator (14).
- **Compass-Temperature or Electronic Vehicle Information Center Display (31)**

The EMIC includes provisions for the following indicators:

- **Airbag Indicator (30)**
- **Ajar Indicators (15 or 31)** - text in odometer display for doors and liftgate in clusters without EVIC, or icons in the EVIC display of vehicles with that option
- **Antilock Brake System (ABS) Indicator (27)**
- **Brake Indicator (19)** - text only for U.S. market, icon only for markets outside U.S.
- **Charging Indicator (23)**
- **Cruise Indicator (13)**
- **Electronic Stability Program (ESP)/Brake Assist System (BAS) Indicator (9)**
- **Electronic Throttle Control (ETC) Indicator (20)**
- **Engine Coolant Temperature Indicator (4)**
- **Front Fog Lamp Indicator (28)** - with optional front fog lamps only
- **Gas Cap Indicator** - textual message in odometer display (15)
- **Gear Selector Indicator (12)** - with automatic transmission only
- **High Beam Indicator (7)**
- **Low Fuel Indicator (2)**
- **Low Oil Pressure Indicator (29)**
- **Malfunction Indicator Lamp (MIL) (16)**
- **Rear Fog Lamp Indicator (21)** - in markets where rear fog lamps are available only
- **Seat Belt Indicator (3)**
- **Security Indicator (8)**
- **Service Four-Wheel Drive (4WD) Indicator (26)** - with optional four-wheel drive system only

2007 Dodge Nitro R/T

2007 ACCESSORIES AND EQUIPMENT Instrument Cluster - Service Information - Nitro

- **Tire Pressure Monitor (TPM) Indicator (14)**
- **Tow/Haul Indicator (10)** - with automatic transmission only
- **Traction Control/Electronic Stability Program (ESP) Indicator (24)**
- **Transmission Temperature Indicator (18)** - with automatic transmission only
- **Turn Signal (Right and Left) Indicators (17)**
- **Wait-To-Start Indicator (22)** - with diesel engine only
- **Water-In-Fuel Indicator (25)** - with diesel engine only

Each indicator in the EMIC, except those located within a VFD unit, is illuminated by a dedicated LED that is soldered onto the EMIC electronic circuit board. Cluster illumination is accomplished by several dimmable LED units, which illuminate each of the gauge dial faces for visibility when the exterior lighting is turned ON. These LED units are not available for service replacement and, if damaged or ineffective, the entire EMIC must be replaced.

Hard wired circuitry connects the EMIC to the electrical system of the vehicle. These hard wired circuits are integral to several wire harnesses, which are routed throughout the vehicle and retained by many different methods. These circuits may be connected to each other, to the vehicle electrical system and to the EMIC through the use of a combination of soldered splices, splice block connectors, and many different types of wire harness terminal connectors and insulators. Refer to the appropriate wiring information. The wiring information includes wiring diagrams, proper wire and connector repair procedures, further details on wire harness routing and retention, as well as pin-out and location views for the various wire harness connectors, splices and grounds.

The EMIC module for this vehicle is serviced only as a complete unit. The EMIC module cannot be adjusted or repaired. If a gauge, an LED unit, a VFD unit, the electronic circuit board, the circuit board hardware, the cluster overlay or the cluster housing are damaged or ineffective, the entire EMIC module must be replaced. The cluster lens and the cluster hood and mask unit are available for separate service replacement.

OPERATION

INSTRUMENT CLUSTER

The Electro Mechanical Instrument Cluster (EMIC) in this vehicle also includes the hardware and software necessary to serve as the electronic body control module and is sometimes referred to as the Cab Compartment Node or CCN. The following information deals primarily with the instrument cluster functions of this unit. Additional details of the electronic body control functions of this unit may be found within the service information for the system or component that the EMIC controls. For example: Additional details of the audible warning functions of the EMIC are found within the Chime/Buzzer service information.

The EMIC is designed to allow the vehicle operator to monitor the conditions of many of the vehicle components and operating systems. The gauges and indicators in the EMIC provide valuable information about the various standard and optional powertrains, fuel and emissions systems, cooling systems, lighting systems, safety systems and many other convenience items. The EMIC is installed in the instrument panel so that all of these monitors can be easily viewed by the vehicle operator when driving, while still allowing relative ease of access for service.

2007 Dodge Nitro R/T

2007 ACCESSORIES AND EQUIPMENT Instrument Cluster - Service Information - Nitro

The microprocessor-based EMIC hardware and software uses various inputs to control the gauges and indicators visible on the face of the cluster. Some of these inputs are hard wired, but most are in the form of electronic messages that are transmitted by other electronic modules over the Controller Area Network (CAN) data bus or the Local Interface Network (LIN) data bus. The EMIC is the master node for the LIN data bus. Refer to **OPERATION** .

The EMIC microprocessor smooths the input data using algorithms to provide gauge readings that are accurate, stable and responsive to operating conditions. These algorithms are designed to provide gauge readings during normal operation that are consistent with customer expectations. However, when abnormal conditions exist such as high coolant temperature, the algorithm can drive the gauge pointer to an extreme position and the microprocessor can sound a chime through the on-board audible tone transducer to provide distinct visual and audible indications of a problem to the vehicle operator. The EMIC may also produce audible warnings for other electronic modules in the vehicle based upon electronic **tone request** messages received over the CAN or LIN data bus. Each audible warning is intended to provide the vehicle operator with an audible alert to supplement a visual indication.

The EMIC circuitry operates on battery current received through a fused B(+) fuse on a non-switched fused B (+) circuit, and on battery current received through a fused ignition switch output (run-start) fuse on a fused ignition switch output (run-start) circuit. This arrangement allows the EMIC to provide some features regardless of the ignition switch position, while other features will operate only with the ignition switch in the ON or START positions. The EMIC circuitry is grounded through a ground circuit and take out of the instrument panel wire harness with an eyelet terminal connector that is secured by a ground screw to a ground location on the instrument panel structural support.

The EMIC also has a self-diagnostic actuator test capability, which will test each of the CAN or LIN bus message-controlled functions of the cluster by lighting the appropriate indicators, positioning the gauge needles at several predetermined calibration points across the gauge faces, and illuminating all segments of the Vacuum-Fluorescent Display (VFD) units. See **DIAGNOSIS AND TESTING**.

GAUGES

All gauges receive battery current through the EMIC circuitry only when the ignition switch is in the ON or START positions. With the ignition switch in the OFF position battery current is not supplied to any gauges, and the EMIC circuitry is programmed to move all of the gauge needles back to the low end of their respective scales. Therefore, the gauges do not accurately indicate any vehicle condition unless the ignition switch is in the ON or START positions.

Each of the EMIC gauges contains an electronically controlled stepper motor unit. The EMIC circuitry completely controls the activation and deactivation of these stepper motors to position each gauge needle in the appropriate position based upon cluster programming and electronic messages received over the CAN or LIN data bus.

The gauges are diagnosed using the self-diagnostic Cab Compartment Node (CCN) actuator test. Proper testing of the CAN or LIN data bus and the electronic data bus message inputs to the EMIC that control each gauge requires the use of a diagnostic scan tool. Refer to the appropriate diagnostic information. Specific operation details for each gauge may be found elsewhere in this service information.

VACUUM-FLUORESCENT DISPLAYS

2007 Dodge Nitro R/T

2007 ACCESSORIES AND EQUIPMENT Instrument Cluster - Service Information - Nitro

The Vacuum-Fluorescent Display (VFD) units are soldered to the EMIC electronic circuit board. Both the standard odometer unit located below the tachometer and the optional compass/temperature unit located below the minor gauge set are fixed segment displays. The optional Electronic Vehicle Information Center (EVIC) VFD unit located below the minor gauge set is a reconfigurable segment display. With the ignition switch in the OFF or ACCESSORY positions, both VFD displays are activated and the total odometer information is displayed when the driver door is opened (Rental Car Mode) and are deactivated when the driver door is closed or after five minutes, whichever occurs first. Otherwise, both display units are active when the ignition switch is in the ON or START positions, and inactive when the ignition switch is in the OFF or ACCESSORY positions.

The illumination intensity of the VFD units is controlled by the EMIC circuitry based upon electronic **dimming level** messages received over the CAN data bus indicating the exterior lighting is turned ON and the dimming level selected using the panel dimmer function of the control sleeve on the control stalk of the left (lighting) multi-function switch. The illumination intensity of the EMIC VFD units is synchronized with that of other display units in the vehicle by sending the same electronic **dimming level** message inputs to all electronic modules in the vehicle over the CAN or LIN data bus. However, if the Tire Pressure Monitor (TPM) indicator or Malfunction Indicator Lamp (MIL) is active, the odometer VFD will illuminate at full daytime brightness until the TPM indicator or MIL is extinguished.

The odometer VFD unit has several display capabilities including odometer, trip odometer A and B, gear selector indication (PRNDL) for vehicles with an automatic transmission, several warning or reminder indications, and various diagnostic information when certain fault conditions exist. On vehicles not equipped with the optional compass/temperature display or EVIC, the odometer display toggles to an outside temperature display following Trip B. The compass/temperature VFD unit displays numerous warning or reminder textual messages, compass, temperature, the customer programmable features interface and various diagnostic information when certain fault conditions exist. An odometer/trip odometer switch on the EMIC circuit board is used to control many of the display modes of the VFD units. These switches are actuated manually by depressing the odometer/trip odometer push button that extends through the lower edge of the cluster lens, adjacent to the odometer VFD.

Actuating the odometer/trip odometer push button momentarily with the ignition switch in the ON position will toggle the odometer VFD between the odometer and trip odometer modes. Depressing the odometer/trip odometer push button for about two seconds while the VFD is in the trip odometer mode will reset the trip odometer value to zero. Holding the odometer/trip odometer push button depressed while turning the ignition switch from the OFF position to the ON position will initiate the CCN self-diagnostic actuator test. Refer to the instrument cluster diagnosis and testing service information for additional details on this cluster function. The EMIC microprocessor remembers which odometer display mode is active when the ignition switch is turned to the OFF position, and returns the display to that mode when the ignition switch is turned ON again.

Actuating the odometer/trip odometer push button momentarily with the ignition switch in the ON position will toggle the CMTC VFD between the various display functions and the various customer programmable feature selectors. The EMIC microprocessor remembers which display modes are active when the ignition switch is turned to the OFF position, and returns the display to that mode when the ignition switch is turned ON again.

Both VFD units are diagnosed using the self-diagnostic Cab Compartment Node (CCN) actuator test. See **DIAGNOSIS AND TESTING**. Proper testing of the CAN or LIN data bus message inputs to the EMIC that control some of the VFD functions requires the use of a diagnostic scan tool. Refer to the appropriate diagnostic information. Specific operation details for the odometer, the trip odometer, the gear selector indicator, the

compass/temperature display, the EVIC and the various warning and reminder indicator functions of the VFD units may be found elsewhere in this service information.

INDICATORS

Indicators are located in various positions within the EMIC and are all connected to the EMIC electronic circuit board. Some indicators operate based upon hard wired inputs to the EMIC, but most are controlled by CAN or LIN data bus messages from other electronic modules in the vehicle. Some are controlled by a combination of hard wired inputs, electronic messaging and EMIC programming. If the EMIC loses CAN data bus communication, the EMIC circuitry will automatically turn ON the Malfunction Indicator Lamp (MIL) until CAN data bus communication is restored.

The various EMIC indicators are controlled by different strategies; some receive fused ignition switch output from the EMIC circuitry and have a switched ground, while others are grounded through the EMIC circuitry and have a switched battery feed. However, all indicators are completely controlled by the EMIC microprocessor based upon various hard wired and electronic message inputs. The cruise and 4WD indicators located within the odometer VFD unit are dimmable. All other indicators are illuminated at a fixed intensity, which is not affected by the selected illumination intensity of the EMIC general illumination LED units. The illumination intensity of the dimmable indicators is synchronized with that of the general illumination lighting.

In addition, certain indicators in this instrument cluster are automatically or self-configured. This feature allows the configurable indicators to be enabled by the EMIC circuitry for compatibility with certain optional equipment. These indicators are enabled or disabled by an electronic **configuration** message sent to the EMIC by the Totally Integrated Power Module (TIPM). The TIPM defaults for the ABS indicator and airbag indicator are enabled, and these configuration settings must be programmatically disabled in the TIPM using a diagnostic scan tool for vehicles that do not have this equipment. The automatically or self-configured indicators remain latent in each EMIC at all times and will be active only when the EMIC receives the appropriate CAN or LIN bus message inputs for that optional system or equipment.

The hard wired indicator inputs may be diagnosed using conventional diagnostic tools and procedures. However, the EMIC circuitry and electronic CAN or LIN data bus message controlled indicators are diagnosed using the self-diagnostic Cab Compartment Node (CCN) actuator test. See **DIAGNOSIS AND TESTING**. Proper testing of the CAN or LIN data bus and the electronic data bus message inputs to the EMIC that control each indicator requires the use of a diagnostic scan tool. Refer to the appropriate diagnostic information. Specific details of the operation for each indicator may be found elsewhere in this service information.

CLUSTER ILLUMINATION

The EMIC has several Light Emitting Diode (LED) units that provide cluster back lighting whenever the exterior lighting is turned ON. The illumination intensity of these LED units is adjusted when the panel lamps dimmer function of the control sleeve on the control stalk of the left (lighting) multi-function switch is rotated to one of six available minor detent positions. The EMIC monitors an electronic **dimming level** message input received over the LIN data bus from the Steering Control Module (SCM) to determine the selected lighting level. In response to that input, the EMIC electronic circuitry converts a fused 12-volt input it receives on a hard wired panel lamps dimmer switch signal circuit into a 12-volt Pulse Width Modulated (PWM) output.

The EMIC uses this PWM output to control the illumination intensity of the cluster general illumination lighting and the VFD units on the EMIC circuit board, then provides a synchronized PWM output on various hard wired

fused panel lamps dimmer switch signal circuits to control and synchronize the illumination intensity of other incandescent illumination lamps in the vehicle. The EMIC also transmits electronic **dimming level** messages over the CAN and LIN data bus to other electronic modules in the vehicle to control and synchronize the illumination intensity of their display units to that of the EMIC displays.

The hard wired panel lamps dimmer outputs from the EMIC may be diagnosed using conventional diagnostic tools and procedures. However, proper testing of the PWM processing of the EMIC and the electronic **dimming level** messages received by the EMIC over the LIN data bus requires the use of a diagnostic scan tool. Refer to the appropriate diagnostic information.

DIAGNOSIS AND TESTING

INSTRUMENT CLUSTER

WARNING: To avoid serious or fatal injury on vehicles equipped with airbags, disable the Supplemental Restraint System (SRS) before attempting any steering wheel, steering column, airbag, Occupant Classification System (OCS), seat belt tensioner, impact sensor, or instrument panel component diagnosis or service. Disconnect and isolate the battery negative (ground) cable, then wait two minutes for the system capacitor to discharge before performing further diagnosis or service. This is the only sure way to disable the SRS. Failure to take the proper precautions could result in accidental airbag deployment.

If all of the instrument cluster gauges and indicators are ineffective, be certain to check the instrument cluster fused B(+) fuse and the instrument cluster fused B(+) and ground circuits for shorts or opens. Refer to the appropriate wiring information. The wiring information includes wiring diagrams, proper wire and connector repair procedures, details of wire harness routing and retention, connector pin-out information and location views for the various wire harness connectors, splices and grounds.

If an individual hard wired gauge or indicator is ineffective, refer to the diagnosis and testing service information for that specific gauge or indicator. If an individual Controller Area Network (CAN) or Local Interface Network (LIN) data bus message-controlled gauge or indicator is ineffective, perform the Actuator Test as follows:

CAUTION: Instrument clusters used in this vehicle automatically configure themselves for compatibility with the features and optional equipment in the vehicle in which they are initially installed. The instrument cluster is programmed to do this by embedding the Vehicle Identification Number (VIN) and other information critical to proper cluster operation into electronic memory. This embedded information is learned through electronic messages received from other electronic modules in the vehicle over the Controller Area Network (CAN) data bus, and through certain hard wired inputs received when the cluster is connected to the vehicle electrically. Once configured, the instrument cluster memory may be irreparably damaged and certain irreversible configuration errors may occur if the cluster is connected electrically to another vehicle; or, if an

electronic module from another vehicle is connected that provides data to the instrument cluster (including odometer values) that conflicts with that which was previously learned and stored. Therefore, the practice of exchanging (swapping) instrument clusters and other electronic modules in this vehicle with those removed from another vehicle must always be avoided. Failure to observe this caution may result in instrument cluster damage, which is not reimbursable under the terms of the product warranty. Service replacement instrument clusters are provided with the correct VIN, and the certified odometer and engine hours values embedded into cluster memory, but will otherwise be automatically configured for compatibility with the features and optional equipment in the vehicle in which they are initially installed.

NOTE: Certain indicators in this instrument cluster are automatically configured. This feature allows those indicators to be activated or deactivated for compatibility with certain optional equipment. If the problem being diagnosed involves improper illumination of the cruise indicator, the electronic throttle control indicator, the fog lamp indicator, any of the four-wheel drive indicators, the transmission overtemp indicator, the security indicator or the gear selector indicator, disconnect and isolate the battery negative cable. After about five minutes, reconnect the battery negative cable and turn the ignition switch to the ON position. The instrument cluster should automatically relearn the equipment in the vehicle and properly configure the configurable indicators accordingly.

ACTUATOR TEST

The instrument cluster actuator test will put the instrument cluster into its self-diagnostic mode. In this mode the instrument cluster can perform a self-diagnostic test that will confirm that the instrument cluster circuitry, the gauges and the indicators are capable of operating as designed. During the actuator test the instrument cluster circuitry will position each of the gauge needles at various calibration points, illuminate each of the segments in the Vacuum-Fluorescent Display (VFD) units, and turn all of the indicators ON and OFF again.

Successful completion of the actuator test will confirm that the instrument cluster is operational. However, there may still be a problem with the CAN or LIN data bus, the Powertrain Control Module (PCM), the Totally Integrated Power Module (TIPM), the Controller Antilock Brake (CAB), the Occupant Restraint Controller (ORC), the compass module, the Sentry Key REmote Entry Module (SKREEM) (also known as the Wireless Control Module/WCM), the Steering Wheel Switch Module (SWSM) or the inputs to one of these electronic control modules. Use a diagnostic scan tool to diagnose these components. Refer to the appropriate diagnostic information.

1. Begin the test with the ignition switch in the OFF position.
2. Depress the odometer/trip odometer switch button.
3. While still holding the odometer/trip odometer switch button depressed, turn the ignition switch to the ON position, but do not start the engine.
4. Release the odometer/trip odometer switch button.
5. The instrument cluster will simultaneously begin to illuminate all of the operational segments in the VFD

units, and perform a bulb check of each operational LED indicator. The VFD segments and LED indicators remain illuminated as each gauge needle is swept to several calibration points and back. If a VFD segment or an LED indicator fails to illuminate, or if a gauge needle fails to sweep through the calibration points and back during this test, the instrument cluster must be replaced.

6. The actuator test is now completed. The instrument cluster will automatically exit the self-diagnostic mode and return to normal operation at the completion of the test. The actuator test will be aborted if the ignition switch is turned to the OFF position, or if an electronic **vehicle speed** message indicating that the vehicle is moving is received over the CAN data bus during the test.
7. Go back to step 1 to repeat the test, if necessary.

REMOVAL

INSTRUMENT CLUSTER

WARNING: To avoid serious or fatal injury on vehicles equipped with airbags, disable the Supplemental Restraint System (SRS) before attempting any steering wheel, steering column, airbag, Occupant Classification System (OCS), seat belt tensioner, impact sensor, or instrument panel component diagnosis or service. Disconnect and isolate the battery negative (ground) cable, then wait two minutes for the system capacitor to discharge before performing further diagnosis or service. This is the only sure way to disable the SRS. Failure to take the proper precautions could result in accidental airbag deployment.

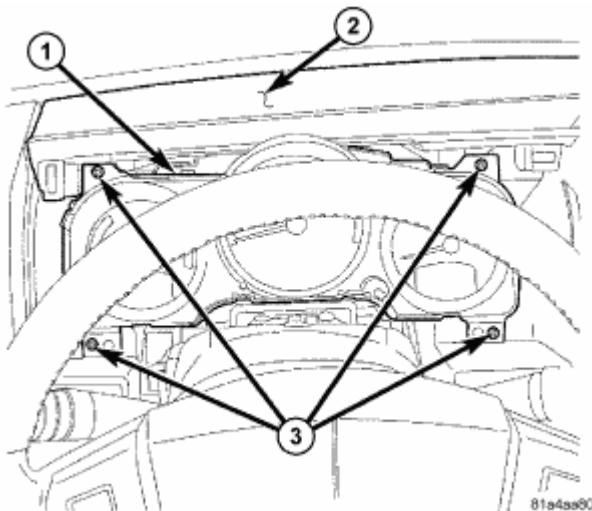

Fig. 4: Removing/Installing Screws That Secure Instrument Cluster To Instrument Panel Base Trim
Courtesy of CHRYSLER LLC

1. Disconnect and isolate the battery negative cable.
2. Remove the cluster bezel from the instrument panel. Refer to **REMOVAL**.
3. Remove the four screws (3) that secure the instrument cluster (1) to the instrument panel base trim (2).
4. Pull the top of the instrument cluster rearward far enough to access and disconnect the instrument panel

wire harness connectors from the connector receptacles on the back of the cluster housing.

- Remove the instrument cluster from the instrument panel.

DISASSEMBLY

INSTRUMENT CLUSTER

WARNING: To avoid serious or fatal injury on vehicles equipped with airbags, disable the Supplemental Restraint System (SRS) before attempting any steering wheel, steering column, airbag, Occupant Classification System (OCS), seat belt tensioner, impact sensor, or instrument panel component diagnosis or service. Disconnect and isolate the battery negative (ground) cable, then wait two minutes for the system capacitor to discharge before performing further diagnosis or service. This is the only sure way to disable the SRS. Failure to take the proper precautions could result in accidental airbag deployment.

NOTE: Some of the components for the instrument cluster used in this vehicle are serviced individually. The serviced components include the cluster lens and the cluster hood and mask unit. Following are the procedures for disassembling these components from the instrument cluster.

CLUSTER LENS

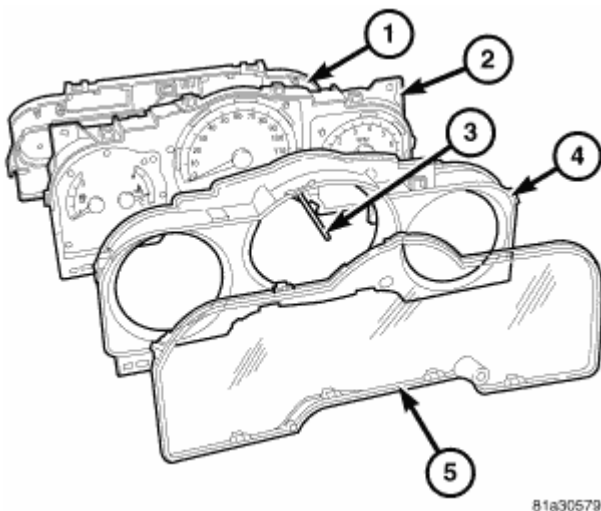

81a30579

Fig. 5: Identifying Plastic Rear Cover, Cluster Housing, Plastic Cluster Lens & Mask Unit
 Courtesy of CHRYSLER LLC

- Disconnect and isolate the battery negative cable.
- Remove the instrument cluster from the instrument panel. See **REMOVAL**.
- Working around the perimeter of the cluster, disengage each of the nine integral latch features that secure the cluster lens (5) to the cluster hood and mask unit (3) and to the cluster housing (2).

- Remove the lens from the face of the cluster hood and mask unit.

CLUSTER HOOD AND MASK

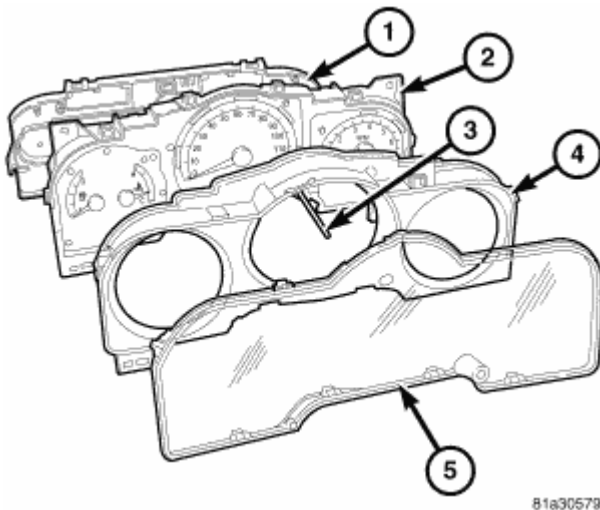

81a30579

Fig. 6: Identifying Plastic Rear Cover, Cluster Housing, Plastic Cluster Lens & Mask Unit

Courtesy of CHRYSLER LLC

- Disconnect and isolate the battery negative cable.
- Remove the instrument cluster from the instrument panel. See **REMOVAL**.
- Remove the cluster lens (5) from the face of the cluster hood and mask unit (3). Refer to step **CLUSTER LENS**.
- Working around the perimeter of the cluster, disengage each of the eight integral latch features that secure the cluster hood and mask unit to the cluster housing (2).
- Remove the hood and mask unit from the face of the instrument cluster.

ASSEMBLY

INSTRUMENT CLUSTER

WARNING: To avoid serious or fatal injury on vehicles equipped with airbags, disable the Supplemental Restraint System (SRS) before attempting any steering wheel, steering column, airbag, Occupant Classification System (OCS), seat belt tensioner, impact sensor, or instrument panel component diagnosis or service. Disconnect and isolate the battery negative (ground) cable, then wait two minutes for the system capacitor to discharge before performing further diagnosis or service. This is the only sure way to disable the SRS. Failure to take the proper precautions could result in accidental airbag deployment.

NOTE: Some of the components for the instrument cluster used in this vehicle are serviced individually. The serviced components include the cluster lens and the

cluster hood and mask unit. Following are the procedures for assembling these components onto the instrument cluster.

CLUSTER LENS

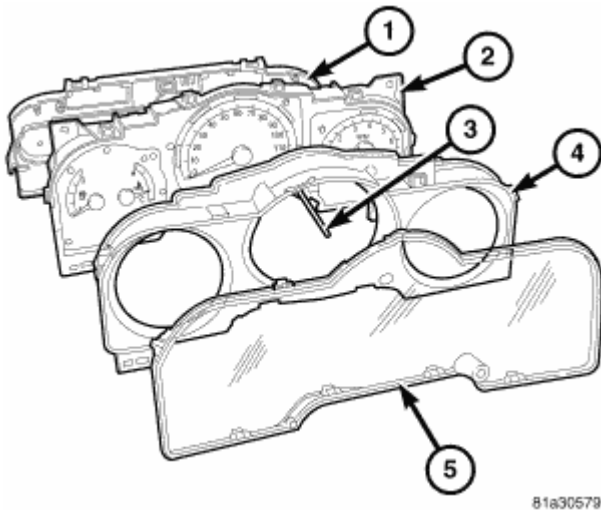
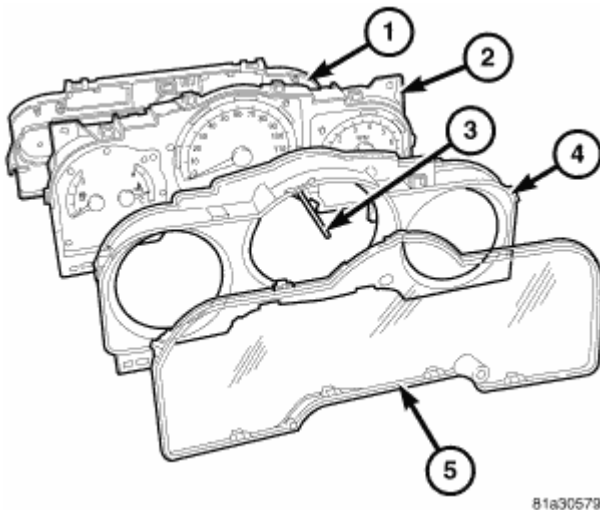

Fig. 7: Identifying Plastic Rear Cover, Cluster Housing, Plastic Cluster Lens & Mask Unit
Courtesy of CHRYSLER LLC

1. Position the cluster lens (5) over the face of the cluster hood and mask unit (3). Be certain that the rubber grommet (4) for the odometer/trip odometer switch push button is installed in the clearance hole in the lens, and that the push button is engaged through the grommet.
2. Working around the perimeter of the cluster, press the lens over the face of the hood and mask until each of the nine integral latch features is fully engaged in the receptacles of the hood and mask or the cluster housing (2).
3. Reinstall the instrument cluster onto the instrument panel. See **INSTALLATION**.
4. Reconnect the battery negative cable.

CLUSTER HOOD AND MASK



81a30579

Fig. 8: Identifying Plastic Rear Cover, Cluster Housing, Plastic Cluster Lens & Mask Unit
Courtesy of CHRYSLER LLC

1. Position the cluster hood and mask unit (3) over the face of the cluster housing (2). Be certain that the odometer/trip odometer switch push button is inserted through the clearance hole in the mask.
2. Working around the perimeter of the cluster, press the hood and mask over the face of the cluster housing until each of the eight integral latch features is fully engaged in the receptacles of the housing.
3. Reinstall the cluster lens (5) onto the face of the cluster hood and mask unit. Refer to step **CLUSTER LENS**.
4. Reinstall the instrument cluster onto the instrument panel. See **INSTALLATION**.
5. Reconnect the battery negative cable.

INSTALLATION

INSTRUMENT CLUSTER

WARNING: To avoid serious or fatal injury on vehicles equipped with airbags, disable the Supplemental Restraint System (SRS) before attempting any steering wheel, steering column, airbag, Occupant Classification System (OCS), seat belt tensioner, impact sensor, or instrument panel component diagnosis or service. Disconnect and isolate the battery negative (ground) cable, then wait two minutes for the system capacitor to discharge before performing further diagnosis or service. This is the only sure way to disable the SRS. Failure to take the proper precautions could result in accidental airbag deployment.

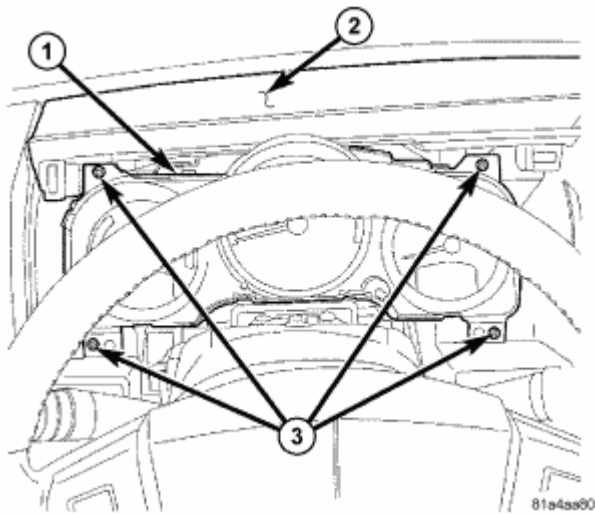

Fig. 9: Removing/Installing Screws That Secure Instrument Cluster To Instrument Panel Base Trim
 Courtesy of CHRYSLER LLC

1. Position the instrument cluster (1) close enough to the instrument panel to reconnect the instrument panel wire harness connectors to the connector receptacles on the back of the cluster housing.
2. Position the instrument cluster mounting tabs to the mounting holes in the instrument panel base trim (2).
3. Install and tighten the four screws (3) that secure the mounting tabs of the instrument cluster. Tighten the screws to 2 N.m (17 in. lbs.).
4. Reinstall the cluster bezel onto the instrument panel. Refer to **INSTALLATION**.
5. Reconnect the battery negative cable.

NOTE: Certain indicators in this instrument cluster are automatically configured. This feature allows those indicators to be activated or deactivated for compatibility with certain optional equipment. If a problem is noted that involves improper illumination of an indicator, disconnect and isolate the battery negative cable. After about five minutes, reconnect the battery negative cable and turn the ignition switch to the ON position. The instrument cluster should automatically relearn the equipment in the vehicle and properly configure the configurable indicators accordingly.

SPECIFICATIONS

INSTRUMENT CLUSTER

TORQUE SPECIFICATIONS

DESCRIPTION	N-m	Ft. Lbs.	In. Lbs.
Instrument Cluster Mounting Screws	2	-	17
Instrument Panel Switch Pod Mounting Screws	2	-	17

ABS INDICATOR

DESCRIPTION

ABS INDICATOR



Fig. 10: ABS Indicator
Courtesy of CHRYSLER LLC

An Antilock Brake System (ABS) indicator is standard equipment on all instrument clusters. This indicator is located near the bottom of the speedometer dial face of the cluster overlay, just left of center. Illumination of this indicator may also be accompanied by the display of certain textual messages in the cluster odometer display.

The ABS indicator consists of a stencil-like cutout of the International Control and Display Symbol icon for **Failure of Anti-lock Braking System** in the opaque layer of the instrument cluster overlay. The dark outer layer of the overlay prevents the indicator from being clearly visible when it is not illuminated. An amber Light Emitting Diode (LED) behind the cutout in the opaque layer of the overlay causes the indicator to appear in amber through the translucent outer layer of the overlay when it is illuminated from behind by the LED, which is soldered onto the instrument cluster electronic circuit board.

The ABS indicator is serviced as a unit with the instrument cluster.

OPERATION

ABS INDICATOR

The ABS indicator gives an indication to the vehicle operator when the ABS system, or a circuit or component of the system is ineffective. This indicator is controlled by a transistor on the instrument cluster circuit board based upon cluster programming and electronic messages received by the cluster from the Controller Antilock Brake (CAB) over the Controller Area Network (CAN) data bus.

The ABS indicator Light Emitting Diode (LED) is completely controlled by the instrument cluster logic circuit, and that logic will only allow this indicator to operate when the instrument cluster receives a battery current input on the fused ignition switch output (run-start) circuit. Therefore, the LED will always be OFF when the

ignition switch is in any position except ON or START. The LED only illuminates when it is provided a path to ground by the instrument cluster transistor. The instrument cluster will turn ON the ABS indicator for the following reasons:

- **Bulb Test** - Each time the ignition switch is turned to the ON position the ABS indicator is illuminated for about three seconds as a bulb test. The entire bulb test is a function of the CAB.
- **ABS Indicator Lamp-On Message** - Each time the cluster receives an electronic **ABS indicator lamp-ON** message from the CAB, the ABS indicator will be illuminated. The indicator remains illuminated until the cluster receives a lamp-OFF message from the CAB, or until the ignition switch is turned to the OFF position, whichever occurs first.
- **Communication Error** - If the cluster receives no lamp-ON or lamp-OFF messages from the CAB for five consecutive message cycles, the ABS indicator is illuminated. The indicator remains illuminated until the cluster receives a valid message from the CAB, or until the ignition switch is turned to the OFF position, whichever occurs first.
- **Actuator Test** - Each time the instrument cluster is put through the actuator test and the Totally Integrated Power Module (TIPM) is configured for the ABS option, the ABS indicator will be turned ON, then OFF again during the bulb check portion of the test to confirm the functionality of the LED and the cluster control circuitry.
- **ABS Diagnostic Test** - The ABS indicator is blinked ON and OFF by lamp-ON and lamp-OFF messages from the CAB during the performance of the ABS diagnostic tests.

The CAB continually monitors the ABS circuits and sensors to decide whether the system is in good operating condition. The CAB then sends the proper lamp-ON or lamp-OFF message to the Electro Mechanical Instrument Cluster (EMIC) (also known as the Cab Compartment Node/CCN). If the CAB sends a lamp-ON message after the bulb test, it indicates that the CAB has detected a system malfunction or that the ABS system has become ineffective. The CAB will store a Diagnostic Trouble Code (DTC) for any malfunction it detects. Each time the ABS indicator fails to light due to an open or short in the cluster ABS indicator circuit, the cluster sends a message notifying the CAB of the condition, then the instrument cluster and the CAB will each store a DTC and the cluster will flash the brake indicator ON and OFF as a backup to notify the vehicle operator.

For proper diagnosis of the antilock brake system, the CAB, the EMIC, the CAN data bus or the electronic communication related to ABS indicator operation a diagnostic scan tool is required. Refer to the appropriate diagnostic information.

AIRBAG INDICATOR

DESCRIPTION

AIRBAG INDICATOR



Fig. 11: Identifying Airbag Indicator
Courtesy of CHRYSLER LLC

An airbag indicator is standard equipment on all instrument clusters. However, the instrument cluster can be programmed to disable this indicator on vehicles that are not equipped with the airbag system, which is not available in some markets. This indicator is located near the bottom of the speedometer dial face of the cluster overlay, just left of center.

The airbag indicator consists of a stencil-like cutout of the International Control and Display Symbol icon for **Airbag** in the opaque layer of the instrument cluster overlay. The dark outer layer of the overlay prevents the indicator from being clearly visible when it is not illuminated. A red Light Emitting Diode (LED) behind the cutout in the opaque layer of the overlay causes the indicator to appear in red through the translucent outer layer of the overlay when it is illuminated from behind by the LED, which is soldered onto the instrument cluster electronic circuit board.

The airbag indicator is serviced as a unit with the instrument cluster.

OPERATION

AIRBAG INDICATOR

The airbag indicator gives an indication to the vehicle operator when the airbag system, or a circuit or component of the system is ineffective. The airbag indicator is controlled by a transistor on the instrument cluster circuit board based upon cluster programming and electronic messages received by the cluster from the Occupant Restraint Controller (ORC) over the Controller Area Network (CAN) data bus.

The airbag indicator Light Emitting Diode (LED) is completely controlled by the instrument cluster logic circuit, and that logic will only allow this indicator to operate when the instrument cluster receives a battery current input on the fused ignition switch output (run-start) circuit. Therefore, the LED will always be OFF when the ignition switch is in any position except ON or START. The LED only illuminates when it is provided a path to ground by the instrument cluster transistor. The instrument cluster will turn ON the airbag indicator for the following reasons:

- **Bulb Test** - Each time the ignition switch is turned to the ON position the airbag indicator is illuminated for about six to eight seconds. The entire bulb test is a function of the ORC.
- **Airbag Indicator Lamp-On Message** - Each time the cluster receives an electronic **airbag indicator lamp-ON** message from the ORC, the airbag indicator will be illuminated. The indicator remains illuminated for about 12 seconds or until the cluster receives a lamp-OFF message from the ORC, whichever is longer. This indicator will also be extinguished when the ignition switch is turned to the OFF position.
- **Communication Error** - If the cluster receives no lamp-ON or lamp-OFF messages from the ORC for 10 consecutive message cycles, the airbag indicator is illuminated. The indicator remains illuminated until the cluster receives a single lamp-OFF message from the ORC.
- **Actuator Test** - Each time the cluster is put through the actuator test, the airbag indicator will be turned ON, then OFF again during the bulb check portion of the test to confirm the functionality of the LED and the cluster control circuitry. The actuator test illumination of the airbag indicator is a function of the instrument cluster.

The ORC continually monitors the airbag system circuits and sensors to decide whether the system is in good operating condition. The ORC then sends the proper lamp-ON or lamp-OFF message to the Electro Mechanical Instrument Cluster (EMIC) (also known as the Cab Compartment Node/CCN). If the ORC sends a lamp-ON message after the bulb test, it indicates that the ORC has detected a system malfunction or that the airbags and seat belt tensioners may not deploy when required, or may deploy when not required. The ORC will store a Diagnostic Trouble Code (DTC) for any malfunction it detects. Each time the airbag indicator fails to illuminate due to an open or short in the cluster airbag indicator circuit, the cluster sends a message notifying the ORC of the condition, then the instrument cluster and the ORC will each store a DTC.

For proper diagnosis of the airbag system, the ORC, the EMIC, the CAN data bus or the electronic communication related to airbag indicator operation a diagnostic scan tool is required. Refer to the appropriate diagnostic information.

AJAR INDICATORS

DESCRIPTION

AJAR INDICATORS

Door and liftgate ajar indicators are standard equipment on all instrument clusters. The ajar indications appear within the fixed segment odometer Vacuum-Fluorescent Display (VFD) unit. However, on vehicles equipped with an optional Electronic Vehicle Information Center (EVIC), the ajar indications in the odometer VFD are electronically suppressed so as not to duplicate indications that are provided by the EVIC. The odometer VFD ajar indicators are textual messages that appear in place of the odometer/trip odometer information.

The odometer VFD unit is soldered onto the cluster electronic circuit board, and is visible through a window with a smoked clear lens located at the base of the cluster overlay tachometer dial face. The dark lens over the VFD prevents it from being clearly visible when it is not illuminated. The ajar indicator textual messages appear in the same blue-green color and at the same lighting level as the other information displayed in the odometer VFD when it is illuminated by the instrument cluster electronic circuit board.

The ajar indicators are serviced as a unit with the odometer VFD unit in the instrument cluster.

OPERATION

AJAR INDICATORS

The ajar indicators give an indication to the vehicle operator that one or more of the passenger compartment doors or the liftgate may be open or not completely latched. These indicators are controlled by the instrument cluster logic circuit based upon cluster programming and electronic **ajar switch status** messages received by the cluster from the Totally Integrated Power Module (TIPM) over the Controller Area Network (CAN) data bus.

The ajar indicator function of the odometer Vacuum-Fluorescent Display (VFD) unit is completely controlled by the instrument cluster logic circuit, and that logic will only allow this indicator to operate when the instrument cluster receives a battery current input on the fused B(+) circuit. Therefore, the VFD ajar indications can occur regardless of the ignition switch position. The instrument cluster will turn ON the ajar indicator for the following reasons:

- **Ajar Switch Message Input** - Each time the cluster receives a door or liftgate ajar switch status message indicating that a door, the liftgate or any combination of these is open or not completely latched with the ignition switch in any position, the appropriate ajar textual message will be illuminated. If the cluster detects a vehicle speed input greater than zero (kilometers or miles-per-hour) while the ignition switch is in the ON or START positions, the ajar indication will be accompanied by a single chime tone. When the ignition switch is in any position except ON or START, any and all ajar indications will time out after about five minutes.

The TIPM continually monitors the door and liftgate ajar switches to determine the status of the doors and liftgate. The TIPM then sends the proper ajar switch status messages to the EMIC. The door and liftgate ajar switches and their circuits may be diagnosed using conventional diagnostic tools and methods. Refer to the appropriate wiring information.

BRAKE/PARK BRAKE INDICATOR

DESCRIPTION

BRAKE INDICATOR



Fig. 12: Identifying Brake/Park Brake Indicator

Courtesy of CHRYSLER LLC

A brake indicator is standard equipment on all instrument clusters. This indicator is located near the bottom of the speedometer dial face of the cluster overlay, to the right of center.

The brake indicator consists of a stencil-like cutout in the opaque layer of the instrument cluster overlay. The word **BRAKE** is cutout for vehicles manufactured for sale in the U.S. market, or the International Control and Display Symbol icon for **Brake Failure** is cutout for vehicles manufactured for all other markets. The dark outer layer of the overlay prevents the indicator from being clearly visible when it is not illuminated. A red Light Emitting Diode (LED) behind the cutout in the opaque layer of the overlay causes the indicator to appear in red through the translucent outer layer of the overlay when it is illuminated from behind by the LED, which is soldered onto the instrument cluster electronic circuit board.

The brake indicator is serviced as a unit with the instrument cluster.

OPERATION

BRAKE INDICATOR

The brake indicator gives an indication to the vehicle operator when the parking brake is applied, when there are certain brake hydraulic system malfunctions as indicated by a low brake hydraulic fluid level condition, or when the brake fluid level switch is disconnected. The brake indicator can also give an indication when certain faults are detected in the Antilock Brake System (ABS). This indicator is controlled by a transistor on the instrument cluster circuit board based upon cluster programming, electronic messages received by the cluster from the Controller Antilock Brake (CAB) over the Controller Area Network (CAN) data bus, and a hard wired input from the park brake switch.

The brake indicator Light Emitting Diode (LED) is completely controlled by the instrument cluster logic circuit, and that logic will only allow this indicator to operate when the instrument cluster receives a battery current input on the fused ignition switch output (run-start) circuit. Therefore, the LED will always be OFF when the ignition switch is in any position except ON or START. The LED only illuminates when it is provided a path to ground by the instrument cluster transistor. The instrument cluster will turn ON the brake indicator for the following reasons:

- **Bulb Test** - Each time the ignition switch is turned to the ON position the brake indicator is illuminated by the instrument cluster for about three seconds as a bulb test.
- **Brake Indicator Lamp-On Message** - Each time the cluster receives an electronic **brake indicator lamp-ON** message from the CAB, the brake indicator will be illuminated. The CAB may also send lamp-ON messages as feedback during ABS diagnostic procedures. The indicator remains illuminated until the cluster receives a lamp-OFF message from the CAB, or until the ignition switch is turned to the OFF position, whichever occurs first.
- **Park Brake Switch Input** - Each time the cluster detects ground on the park brake switch sense circuit (park brake switch closed = park brake applied or not fully released) while the ignition switch is in the ON position, the brake indicator flashes ON and OFF. The indicator continues to flash until the park brake switch sense input to the cluster is an open circuit (park brake switch open = park brake fully released), or until the ignition switch is turned to the OFF position, whichever occurs first.
- **Antilock Brake System (ABS) Indicator Backup** - If the instrument cluster detects a fault in the ABS indicator circuit it will send a message indicating the fault to the Controller Antilock Brake (CAB), then flash the brake indicator ON and OFF. The cluster will continue to flash the brake indicator until the ABS indicator circuit fault is resolved, or until the ignition switch is turned to the OFF position, whichever occurs first.
- **Actuator Test** - Each time the instrument cluster is put through the actuator test, the brake indicator will be turned ON, then OFF again during the bulb check portion of the test to confirm the functionality of the LED and the cluster control circuitry.

The park brake switch on the park brake lever mechanism provides a hard wired ground input to the instrument cluster circuitry through the park brake switch sense circuit whenever the park brake is applied or not fully released. The Totally Integrated Power Module (TIPM) monitors the brake fluid level switch on the brake master cylinder reservoir, then sends the appropriate electronic messages to the CAB. The CAB continually monitors the ABS system circuits and sensors to decide whether the system is in good operating condition. The CAB then sends the proper lamp-ON or lamp-OFF message to the Electro Mechanical Instrument Cluster (EMIC) (also known as the Cab Compartment Node/CCN). If the CAB sends a lamp-ON message after the bulb test, it indicates that the CAB has detected a brake hydraulic system malfunction or that the ABS system has become ineffective. The CAB will store a Diagnostic Trouble Code (DTC) for any malfunction it detects.

The hard wired park brake switch input to the EMIC may be diagnosed using conventional diagnostic tools and procedures. Refer to the appropriate wiring information. For proper diagnosis of the brake fluid level switch, the ABS, the CAB, the EMIC, the TIPM, the CAN data bus or the electronic communication related to brake indicator operation a diagnostic scan tool is required. Refer to the appropriate diagnostic information.

DIAGNOSIS AND TESTING

BRAKE INDICATOR

WARNING: To avoid serious or fatal injury on vehicles equipped with airbags, disable the Supplemental Restraint System (SRS) before attempting any steering wheel, steering column, airbag, Occupant Classification System (OCS), seat belt tensioner, impact sensor, or instrument panel component diagnosis or service. Disconnect and isolate the battery negative (ground) cable, then wait two minutes for the system capacitor to discharge before

performing further diagnosis or service. This is the only sure way to disable the SRS. Failure to take the proper precautions could result in accidental airbag deployment.

The hard wired park brake switch input to the Electro Mechanical Instrument Cluster (EMIC) may be diagnosed using conventional diagnostic tools and procedures. Refer to the appropriate wiring information. The wiring information includes wiring diagrams, proper wire and connector repair procedures, details of wire harness routing and retention, connector pin-out information and location views for the various wire harness connectors, splices and grounds.

However, conventional diagnostic methods may not prove conclusive in the diagnosis of the EMIC, the Controller Antilock Brake (CAB), the Totally Integrated Power Module (TIPM), the Controller Area Network (CAN) data bus, or the electronic message inputs also used by the EMIC to provide brake indicator operation. The most reliable, efficient, and accurate means to diagnose the EMIC, the CAB, the TIPM, the CAN data bus or the electronic communication related to brake indicator operation requires the use of a diagnostic scan tool. Refer to the appropriate diagnostic information.

CHARGING INDICATOR

DESCRIPTION

CHARGING INDICATOR

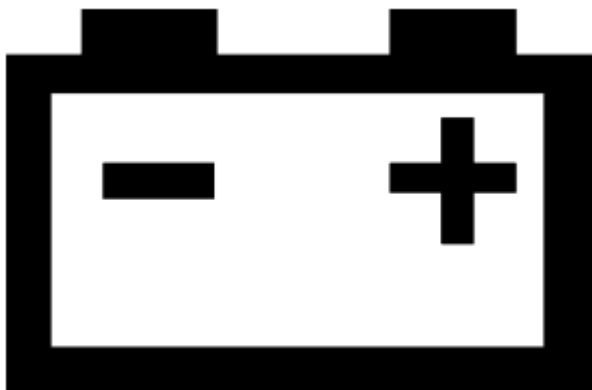

Fig. 13: Charging Indicator
Courtesy of CHRYSLER LLC

A charging indicator is standard equipment on all instrument clusters. This indicator is located near the bottom of the speedometer dial face of the cluster overlay, just right of center.

The charging indicator consists of a stencil-like cutout of the International Control and Display Symbol icon for **Battery Charging Condition** in the opaque layer of the instrument cluster overlay. The dark outer layer of the overlay prevents the indicator from being clearly visible when it is not illuminated. A red Light Emitting Diode (LED) behind the cutout in the opaque layer of the overlay causes the indicator to appear in red through the translucent outer layer of the overlay when it is illuminated from behind by the LED, which is soldered onto the instrument cluster electronic circuit board.

The charging indicator is serviced as a unit with the instrument cluster.

OPERATION

CHARGING INDICATOR

The charging indicator gives an indication to the vehicle operator when the electrical system voltage is too low or too high. This indicator is controlled by a transistor on the instrument cluster circuit board based upon cluster programming and electronic messages received by the cluster from the Powertrain Control Module (PCM) over the Controller Area Network (CAN) data bus.

The charging indicator Light Emitting Diode (LED) is completely controlled by the instrument cluster logic circuit, and that logic will only allow this indicator to operate when the instrument cluster receives a battery current input on the fused ignition switch output (run-start) circuit. Therefore, the LED will always be OFF when the ignition switch is in any position except ON or START. The LED only illuminates when it is provided a path to ground by the instrument cluster transistor. The instrument cluster will turn ON the charging indicator for the following reasons:

- **Bulb Test** - Each time the ignition switch is turned to the ON position the charging indicator is illuminated by the instrument cluster for about three seconds as a bulb test.
- **Voltage Low Message** - Each time the cluster receives an electronic **system voltage** message from the PCM indicating the voltage is low (less than about 11.5 volts is a charge fail condition), the charging indicator will be illuminated. The indicator remains illuminated until the cluster receives a message from the PCM indicating the voltage is normal (greater than about 12.0 volts, but less than 16.0 volts), or until the ignition switch is turned to the OFF position, whichever occurs first.
- **Voltage High Message** - Each time the cluster receives an electronic **system voltage** message from the PCM indicating the voltage is high (greater than about 16.0 volts), the charging indicator will be illuminated. The indicator remains illuminated until the cluster receives a message from the PCM indicating the voltage is normal (less than about 15.5 volts, but greater than 11.5 volts), or until the ignition switch is turned to the OFF position, whichever occurs first.
- **Actuator Test** - Each time the cluster is put through the actuator test, the charging indicator will be turned ON, then OFF again during the bulb check portion of the test to confirm the functionality of the LED and the cluster control circuitry.

The PCM continually monitors the electrical system voltage to control the generator output. The PCM then sends the proper messages to the Electro Mechanical Instrument Cluster (EMIC) (also known as the Cab Compartment Node/CCN). If the instrument cluster turns ON the charging indicator due to a charge fail or voltage high condition, it may indicate that the charging system requires service.

For proper diagnosis of the charging system, the PCM, the EMIC, the CAN data bus or the electronic communication related to charging indicator operation a diagnostic scan tool is required. Refer to the appropriate diagnostic information.

CRUISE INDICATOR

DESCRIPTION

CRUISE INDICATOR

CRUISE

Fig. 14: Cruise Indicator
Courtesy of CHRYSLER LLC

A cruise indicator is standard equipment on all instrument clusters. However, on vehicles not equipped with the optional speed control system, this indicator is electronically disabled. This indicator is located within the odometer Vacuum Fluorescent Display (VFD) unit.

The cruise indicator consists of the text **CRUISE** in the VFD display. The odometer VFD unit is soldered onto the instrument cluster electronic circuit board, and is visible through a window with a smoked clear lens located on the lower edge of the tachometer gauge dial face of the cluster overlay. The dark lens over the VFD prevents it from being clearly visible when it is not illuminated. The cruise indicator text appears in a blue-green color and at the same lighting level as the odometer information when it is illuminated by the instrument cluster electronic circuit board.

During daylight hours (exterior lamps are OFF) the odometer VFD unit is illuminated at full brightness for clear visibility. At night (exterior lamps are ON), the VFD lighting level is adjusted with the other cluster illumination lamps using the panel lamps dimmer function of the interior lighting control sleeve on the left multi-function switch control stalk. However, a PARADE mode position of the control sleeve allows the VFD unit to be illuminated at full brightness if the exterior lamps are turned ON during daylight hours.

The cruise indicator is serviced as a unit with the odometer VFD unit in the instrument cluster.

OPERATION**CRUISE INDICATOR**

The cruise indicator gives an indication to the vehicle operator when the speed control system is ON, regardless of whether the speed control is engaged. This indicator is controlled by the instrument cluster circuit board based upon cluster programming and electronic messages received by the cluster from the Powertrain Control Module (PCM) over the Controller Area Network (CAN) data bus.

The cruise indicator is completely controlled by the instrument cluster logic circuit, and that logic will only allow this indicator to operate when the instrument cluster receives a battery current input on the fused ignition switch output (run-start) circuit. Therefore, the indicator will always be OFF when the ignition switch is in any position except ON or START. The indicator only illuminates when it is energized by the instrument cluster logic circuit. The instrument cluster will turn ON the cruise indicator for the following reasons:

- **Cruise Indicator Lamp-On Message** - Each time the cluster receives an electronic **cruise indicator lamp-ON** message from the PCM indicating the speed control system is ON, the cruise indicator is illuminated. The indicator remains illuminated until the cluster receives a lamp-OFF message from the PCM, or until the ignition switch is turned to the OFF position, whichever occurs first.
- **Actuator Test** - Each time the cluster is put through the actuator test, the cruise indicator will be turned ON, then OFF again during the Vacuum Fluorescent Display (VFD) portion of the test in order to confirm the functionality of the VFD and the cluster control circuitry.

The PCM continually monitors the speed control switches to determine the appropriate outputs to the speed control servo. The PCM then sends the proper lamp-ON or lamp-OFF message to the Electro Mechanical Instrument Cluster (EMIC) (also known as the Cab Compartment Node/CCN).

For proper diagnosis of the speed control system, the PCM, the EMIC, the CAN data bus or the electronic communication related to cruise indicator operation a diagnostic scan tool is required. Refer to the appropriate diagnostic information.

ENGINE TEMPERATURE GAUGE

DESCRIPTION

ENGINE TEMPERATURE GAUGE



Fig. 15: Engine Temperature Gauge Icon
Courtesy of CHRYSLER LLC

An engine coolant temperature gauge is standard equipment on all instrument clusters. This gauge is located on the left side of the instrument cluster, between the fuel gauge and the speedometer. The gauge consists of a movable gauge needle or pointer controlled by the instrument cluster circuitry and a fixed 90 degree gauge scale on the cluster overlay that reads bottom-to-top from **C** (or Cold) to **H** (or Hot). An International Control and Display Symbol icon for **Engine Coolant Temperature** is located on the cluster overlay, adjacent to the hub of the gauge needle.

2007 Dodge Nitro R/T

2007 ACCESSORIES AND EQUIPMENT Instrument Cluster - Service Information - Nitro

The engine coolant temperature gauge graphics are white, gray and black against a black field except for a single red graduation at the high end of the gauge scale, making them clearly visible within the instrument cluster in daylight. When illuminated from behind by the panel lamps dimmer controlled cluster illumination lighting with the exterior lamps turned ON, the graphics all retain their unilluminated colors and appearance. The orange gauge needle has internal optical illumination. Gauge illumination is provided by Light Emitting Diode (LED) units soldered onto the instrument cluster electronic circuit board.

The engine coolant temperature gauge is serviced as a unit with the instrument cluster.

OPERATION

ENGINE TEMPERATURE GAUGE

The engine coolant temperature gauge gives an indication to the vehicle operator of the engine coolant temperature. This gauge is controlled by the instrument cluster circuit board based upon cluster programming and electronic messages received by the cluster from the Powertrain Control Module (PCM) over the Controller Area Network (CAN) data bus.

The engine coolant temperature gauge is driven by an electronic stepper motor unit that receives battery current on the instrument cluster electronic circuit board through the fused ignition switch output (run-start) circuit whenever the ignition switch is in the ON or START positions. The cluster is programmed to move the gauge needle back to the low end of the scale after the ignition switch is turned to the OFF position. The instrument cluster circuitry controls the gauge needle position and provides the following features:

- **Engine Temperature Message** - Each time the cluster receives an electronic **engine temperature** message from the PCM indicating the temperature is between the low end of normal [about 41°C (105°F) for gasoline engines, or about 28°C (82°F) for diesel engines] and the high end of normal [about 124°C (255°F) for gasoline engines, or about 124°C (256°F) for diesel engines], the gauge needle is moved to the actual relative temperature position on the gauge scale.
- **Engine Temperature Low Message** - Each time the cluster receives an electronic **engine temperature** message from the PCM indicating the temperature is low [at or below about 40°C (104°F) for gasoline engines, or about 27°C (81°F) for diesel engines], the gauge needle is held below the graduation on the far left end of the gauge scale. The gauge needle remains below the low end of the gauge scale until the cluster receives a message from the PCM indicating that the temperature is above the low end of normal, or until the ignition switch is turned to the OFF position, whichever occurs first.
- **Engine Temperature High or Critical Message** - Each time the cluster receives an electronic **engine temperature** message from the PCM indicating the temperature is high [at or above about 127°C (261°F) for gasoline engines, or about 125°C (257°F) for diesel engines], the gauge needle is moved to the red graduation at the high end of the gauge scale, the engine temperature indicator is illuminated and a single chime tone is sounded. The gauge needle remains at the red graduation and the engine temperature indicator remains illuminated until the cluster receives a message from the PCM indicating that the temperature is below about 124°C (255°F), or until the ignition switch is turned to the OFF position, whichever occurs first. The chime tone feature will only repeat during the same ignition cycle if the engine temperature indicator is cycled OFF and then ON again by the appropriate messages from the PCM.
- **Communication Error** - If the cluster fails to receive an **engine temperature** message, it will hold the gauge needle at the last indication for about five seconds or until the ignition switch is turned to the OFF

position, whichever occurs first. After five seconds, the cluster will move the gauge needle to the low end of the gauge scale.

- **Actuator Test** - Each time the cluster is put through the actuator test, the engine coolant temperature gauge needle will be swept to several calibration points on the gauge scale in a prescribed sequence in order to confirm the functionality of the gauge and the cluster control circuitry.

The PCM continually monitors the engine coolant temperature sensor to determine the engine operating temperature. The PCM then sends the proper messages to the Electro Mechanical Instrument Cluster (EMIC). If the instrument cluster turns ON the engine temperature indicator due to a high or critical engine coolant temperature gauge reading, it may indicate that the engine or the engine cooling system requires service.

For proper diagnosis of the engine coolant temperature sensor, the PCM, the EMIC, the CAN data bus or the electronic communication related to engine coolant temperature gauge operation a diagnostic scan tool is required. Refer to the appropriate diagnostic information.

ENGINE TEMPERATURE INDICATOR

DESCRIPTION

ENGINE TEMPERATURE INDICATOR



Fig. 16: Identifying Engine Temperature Indicator
Courtesy of CHRYSLER LLC

An engine temperature indicator is standard equipment on all instrument clusters. The engine temperature indicator is located above the engine coolant temperature gauge needle hub on the cluster overlay, to the left of the speedometer.

The engine temperature indicator consists of a stencil-like cutout of the International Control and Display Symbol icon for **Engine Coolant Temperature** in the opaque layer of the instrument cluster overlay. The dark outer layer of the overlay prevents the indicator from being clearly visible when it is not illuminated. A red Light Emitting Diode (LED) behind the cutout in the opaque layer of the overlay causes the indicator to appear in red through the translucent outer layer of the overlay when it is illuminated from behind by the LED, which is soldered onto the instrument cluster electronic circuit board.

The engine temperature indicator is serviced as a unit with the instrument cluster.

OPERATION

ENGINE TEMPERATURE INDICATOR

The engine temperature indicator gives an indication to the vehicle operator when the engine temperature gauge reading reflects a condition requiring immediate attention. This indicator is controlled by a transistor on the instrument cluster circuit board based upon cluster programming and electronic messages received by the cluster from the Powertrain Control Module (PCM) over the Controller Area Network (CAN) data bus.

The engine temperature indicator Light Emitting Diode (LED) is completely controlled by the instrument cluster logic circuit, and that logic will only allow this indicator to operate when the instrument cluster receives a battery current input on the fused ignition switch output (run-start) circuit. Therefore, the LED will always be OFF when the ignition switch is in any position except ON or START. The LED only illuminates when it is provided a path to ground by the instrument cluster transistor. The instrument cluster will turn ON the engine temperature indicator for the following reasons:

- **Bulb Test** - Each time the ignition switch is turned to the ON position the engine temperature indicator is illuminated for about two seconds as a bulb test. The entire bulb test is a function of the PCM.
- **Engine Temperature High or Critical Message** - Each time the cluster receives an electronic **engine temperature** message from the PCM indicating the temperature is high [at or above about 127°C (261°F) for gasoline engines, or about 128°C (262°F) for diesel engines], the engine temperature indicator will be illuminated and a single chime tone is sounded. The indicator remains illuminated until the cluster receives a message from the PCM indicating that the temperature is below about 124°C (255°F), or until the ignition switch is turned to the OFF position, whichever occurs first. The chime tone feature will only repeat during the same ignition cycle if the engine temperature indicator is cycled OFF, then ON again by the appropriate messages from the PCM.
- **Actuator Test** - Each time the cluster is put through the actuator test, the engine temperature indicator will be turned ON, then OFF again during the bulb check portion of the test to confirm the functionality of the LED and the cluster control circuitry.

The PCM continually monitors the engine coolant temperature sensor to determine the engine operating temperature. The PCM then sends the proper messages to the Electro Mechanical Instrument Cluster (EMIC) (also known as the Cab Compartment Node/CCN). For further diagnosis of the engine temperature indicator or the instrument cluster circuitry that controls the LED, see **DIAGNOSIS AND TESTING**. If the instrument cluster turns ON the engine temperature indicator due to a high engine temperature gauge reading, it may indicate that the engine or the engine cooling system requires service.

For proper diagnosis of the engine coolant temperature sensor, the PCM, the EMIC, the CAN data bus or the electronic communication related to engine temperature indicator operation a diagnostic scan tool is required. Refer to the appropriate diagnostic information.

ELECTRONIC STABILITY PROGRAM/BRAKE ASSIST SYSTEM INDICATOR

DESCRIPTION

ESP/BAS INDICATOR

The image shows the ESP/BAS indicator logo, which consists of the letters "ESP" stacked above the letters "BAS" in a bold, sans-serif font.

Fig. 17: Electronic Stability Program/Brake Assist System Indicator
Courtesy of CHRYSLER LLC

An Electronic Stability Program (ESP)/Brake Assist System (BAS) indicator is standard equipment on all instrument clusters. This indicator is located near the base of the speedometer needle hub on the cluster overlay, just right of center.

The ESP/BAS indicator consists of a stencil-like cutout of the text **ESP BAS** in the opaque layer of the instrument cluster overlay. The dark outer layer of the overlay prevents the indicator from being clearly visible when it is not illuminated. An amber Light Emitting Diode (LED) behind the cutout in the opaque layer of the overlay causes the indicator to appear in amber through the translucent outer layer of the overlay when it is illuminated from behind by the LED, which is soldered onto the instrument cluster electronic circuit board.

The ESP/BAS indicator is serviced as a unit with the instrument cluster.

OPERATION

ESP/BAS INDICATOR

The ESP/BAS indicator gives an indication to the vehicle operator when the Electronic Stability Program (ESP)/Brake Assist System (BAS) has been activated. This indicator is controlled by a transistor on the instrument cluster circuit board based upon cluster programming and electronic messages received by the cluster from the Controller Antilock Brake (CAB) and the All-Wheel Drive Control Module (AWDCM) over the Controller Area Network (CAN) data bus.

The ESP/BAS indicator Light Emitting Diode (LED) is completely controlled by the instrument cluster logic circuit, and that logic will only allow this indicator to operate when the instrument cluster receives a battery current input on the fused ignition switch output (run-start) circuit. Therefore, the LED will always be OFF when the ignition switch is in any position except ON or START. The LED only illuminates when it is provided a path to ground by the instrument cluster transistor. The instrument cluster will turn ON the ESP/BAS indicator for the following reasons:

- **Bulb Test** - Each time the ignition switch is turned to the ON position the ESP/BAS indicator is illuminated for about four seconds as a bulb test.

- **ESP/BAS Indicator Lamp-On Message** - Each time the cluster receives an electronic **ESP/BAS indicator lamp-ON** message from the CAB indicating that the ESP/BAS system has been activated, the ESP/BAS indicator will be illuminated. The indicator remains illuminated until the cluster receives a lamp-OFF message from the CAB, or until the ignition switch is turned to the OFF position, whichever occurs first.
- **ESP Full Off Textual Message** - Each time the cluster receives an electronic **ESP Full OFF indicator lamp-ON** message from the CAB indicating that the ESP/BAS system has been manually disabled, an **ESP Full OFF** textual message will appear within the cluster odometer display. The **ESP Full OFF** textual message remains displayed until the cluster receives a lamp-OFF message from the CAB, or until the ignition switch is turned to the OFF position, whichever occurs first.
- **Actuator Test** - Each time the cluster is put through the actuator test, the ESP/BAS indicator will be turned ON, then OFF again during the bulb check portion of the test to confirm the functionality of the LED and the cluster control circuitry.

The CAB continually monitors the ESP/BAS circuits and sensors to decide whether the system is in good operating condition and the proper outputs to the components of the system. The CAB then sends the proper lamp-ON or lamp-OFF message to the Electro Mechanical Instrument Cluster (EMIC) (also known as the Cab Compartment Node/CCN).

For proper diagnosis of the ESP/BAS system, the CAB, the AWDCM, the EMIC, the CAN data bus or the electronic communication related to the ESP/BAS indicator operation a diagnostic scan tool is required. Refer to the appropriate diagnostic information.

ETC INDICATOR

DESCRIPTION

ELECTRONIC THROTTLE CONTROL INDICATOR

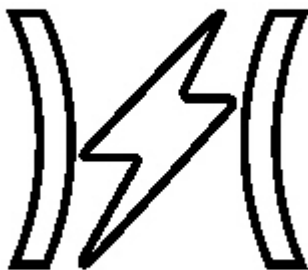

Fig. 18: Electronic Throttle Control Indicator
Courtesy of CHRYSLER LLC

An Electronic Throttle Control (ETC) indicator is standard equipment on all instrument clusters. This indicator is located near the bottom of the speedometer dial face of the cluster overlay, just right of center.

The ETC indicator consists of a stencil-like cutout of the International Control and Display Symbol icon for **Electronic Throttle Control** in the opaque layer of the instrument cluster overlay. The dark outer layer of the overlay prevents the indicator from being clearly visible when it is not illuminated. A red Light Emitting Diode (LED) behind the cutout in the opaque layer of the overlay causes the indicator to appear in red through the translucent outer layer of the overlay when it is illuminated from behind by the LED, which is soldered onto the instrument cluster electronic circuit board.

The ETC indicator is serviced as a unit with the instrument cluster.

OPERATION

ELECTRONIC THROTTLE CONTROL INDICATOR

The Electronic Throttle Control (ETC) indicator gives an indication to the vehicle operator when the ETC system, or a circuit or component of the system is ineffective. The ETC indicator is controlled by a transistor on the instrument cluster circuit board based upon cluster programming and electronic messages received by the cluster from the Powertrain Control Module (PCM) over the Controller Area Network (CAN) data bus.

The ETC indicator Light Emitting Diode (LED) is completely controlled by the instrument cluster logic circuit, and that logic will only allow this indicator to operate when the instrument cluster receives a battery current input on the fused ignition switch output (run-start) circuit. Therefore, the LED will always be OFF when the ignition switch is in any position except ON or START. The LED only illuminates when it is provided a path to ground by the instrument cluster transistor. The instrument cluster will turn ON the ETC indicator for the following reasons:

- **Bulb Test** - Each time the ignition switch is turned to the ON position the ETC indicator is illuminated for about three seconds. The entire bulb test is a function of the instrument cluster.
- **ETC Indicator Lamp-On Message** - Each time the cluster receives an electronic **ETC indicator lamp-ON** message from the PCM, the ETC indicator will be illuminated. The indicator can be flashed ON and OFF, or illuminated solid, as dictated by the PCM message. The indicator remains illuminated solid or continues to flash for about 12 seconds or until the cluster receives a lamp-OFF message from the PCM, whichever is longer. If the indicator is illuminated solid with the engine running the vehicle will usually remain drivable. If the indicator is flashing with the engine running the vehicle may require towing. A flashing indicator means the ETC system requires immediate service. The indicator will be extinguished when the ignition switch is turned to the OFF position.
- **Actuator Test** - Each time the cluster is put through the actuator test, the ETC indicator will be turned ON, then OFF again during the bulb check portion of the test to confirm the functionality of the LED and the cluster control circuitry. The actuator test illumination of the ETC indicator is a function of the PCM.

The PCM continually monitors the ETC system circuits and sensors to decide whether the system is in good operating condition. The PCM then sends the proper lamp-ON or lamp-OFF message to the Electro Mechanical Instrument Cluster (EMIC) (also known as the Cab Compartment Node/CCN). If the PCM sends a lamp-ON message after the bulb test, it indicates that the PCM has detected an ETC system malfunction or that the ETC system is ineffective. The PCM will store a Diagnostic Trouble Code (DTC) for any malfunction it detects.

Each time the ETC indicator fails to illuminate due to an open or short in the cluster ETC indicator circuit, the cluster sends a message notifying the PCM of the condition, then the EMIC and the PCM will each store a DTC.

For proper diagnosis of the ETC system, the PCM, the EMIC, the CAN data bus or the electronic communication related to ETC indicator operation a diagnostic scan tool is required. Refer to the appropriate diagnostic information.

FRONT FOG LAMP INDICATOR

DESCRIPTION

FRONT FOG LAMP INDICATOR



Fig. 19: Front Fog Lamp Indicator
Courtesy of CHRYSLER LLC

A front fog lamp indicator is standard equipment on all instrument clusters. However, on vehicles not equipped with the optional front fog lamps, this indicator is electronically disabled. This indicator is located near the bottom of the speedometer dial face of the cluster overlay, just left of center.

The front fog lamp indicator consists of a stencil-like cutout of the International Control and Display Symbol icon for **Front Fog Light** in the opaque layer of the instrument cluster overlay. The dark outer layer of the overlay prevents the indicator from being clearly visible when it is not illuminated. A green Light Emitting Diode (LED) behind the cutout in the opaque layer of the overlay causes the indicator to appear in green through the translucent outer layer of the overlay when it is illuminated from behind by the LED, which is soldered onto the instrument cluster electronic circuit board.

The front fog lamp indicator is serviced as a unit with the instrument cluster.

OPERATION

FRONT FOG LAMP INDICATOR

The front fog lamp indicator gives an indication to the vehicle operator whenever the front fog lamps are illuminated. This indicator is controlled by a transistor on the instrument cluster circuit board based upon cluster programming and electronic messages received by the cluster from the Totally Integrated Power Module (TIPM) over the Controller Area Network (CAN) data bus.

The front fog lamp indicator Light Emitting Diode (LED) is completely controlled by the instrument cluster logic circuit, and that logic will allow this indicator to operate whenever the instrument cluster receives a battery current input on the fused B(+) circuit. Therefore, the LED can be illuminated regardless of the ignition switch position. The LED only illuminates when it is provided a path to ground by the instrument cluster transistor. The instrument cluster will turn ON the front fog lamp indicator for the following reasons:

- **Front Fog Indicator Lamp-On Message** - Each time the cluster receives an electronic **front fog indicator lamp-ON** message from the TIPM indicating the front fog lamps are turned ON, the front fog lamp indicator will be illuminated. The indicator remains illuminated until the cluster receives a lamp-OFF message from the TIPM, or until the exterior lamp load shedding (battery saver) timed interval expires, whichever occurs first.
- **Actuator Test** - Each time the cluster is put through the actuator test, the front fog lamp indicator will be turned ON, then OFF again during the bulb check portion of the test to confirm the functionality of the LED and the cluster control circuitry.

The TIPM continually monitors electronic **exterior lighting request** messages from the Electro Mechanical Instrument Cluster (EMIC) (also known as the Cab Compartment Node/CCN) to determine the appropriate outputs to the front fog lamps. The TIPM activates or deactivates the front fog lamps then sends the proper lamp-ON or lamp-OFF message back to the EMIC.

For proper diagnosis of the front fog lamp system, the TIPM, the EMIC, the CAN data bus or the electronic communication related to front fog lamp indicator operation a diagnostic scan tool is required. Refer to the appropriate diagnostic information.

FUEL GAUGE

DESCRIPTION

FUEL GAUGE



Fig. 20: Fuel Gauge Display Symbol
Courtesy of CHRYSLER LLC

A fuel gauge is standard equipment on all instrument clusters. This gauge is located on the left side of the instrument cluster, left of the speedometer and the engine temperature gauge. The gauge consists of a movable gauge needle or pointer controlled by the instrument cluster circuitry and a fixed 90 degree gauge scale on the cluster overlay that reads bottom-to-top from **E** (or Empty) to **F** (or Full). An International Control and Display Symbol icon for **Fuel** is located on the cluster overlay, adjacent to the hub of the gauge needle. An arrowhead pointed to the left side of the vehicle is imprinted on the cluster overlay next to the **Fuel** icon on the gauge to provide the driver with a reminder as to the location of the fuel filler access.

The fuel gauge graphics are white, gray and black against a black field except for a single red graduation at the low end of the gauge scale, making them clearly visible within the instrument cluster in daylight. When illuminated from behind by the panel lamps dimmer controlled cluster illumination lighting with the exterior lamps turned ON, the graphics all retain their unilluminated colors and appearance. The orange gauge needle has internal optical illumination. Gauge illumination is provided by Light Emitting Diode (LED) units soldered onto the instrument cluster electronic circuit board.

The fuel gauge is serviced as a unit with the instrument cluster.

OPERATION

FUEL GAUGE

The fuel gauge gives an indication to the vehicle operator of the level of fuel in the fuel tank. This gauge is controlled by the instrument cluster circuit board based upon cluster programming and electronic **fuel level** messages received by the cluster from the Totally Integrated Power Module (TIPM) over the Controller Area Network (CAN) data bus.

The fuel gauge is driven by an electronic stepper motor unit that receives battery current on the instrument cluster electronic circuit board through the fused ignition switch output (run-start) circuit whenever the ignition

switch is in the ON or START positions. The cluster is programmed to move the gauge needle back to the low end of the scale after the ignition switch is turned to the OFF position. The instrument cluster circuitry controls the gauge needle position and provides the following features:

- **Fuel Level Message** - The TIPM provides a constant current source to the fuel level sending unit and monitors a return input on a fuel level sense circuit. The resistance through the fuel level sending unit increases as the fuel level rises and decreases as the fuel level falls causing changes in the fuel level sense input voltage. The TIPM then sends the appropriate electronic **fuel level** messages to the cluster. The cluster programming applies an algorithm to calculate the proper fuel gauge needle position based upon the fuel level message input, then moves the gauge needle to the proper relative position on the gauge scale. This algorithm is used to dampen gauge needle movement against the negative effect that fuel sloshing within the fuel tank can have on accurate inputs from the fuel tank sending unit to the TIPM.
- **Less Than 11 Percent Tank Full Message** - Each time the fuel level message to the cluster indicates the fuel tank is about 11 percent full or less for 10 consecutive seconds and the vehicle speed is zero, or for 60 consecutive seconds and the vehicle speed is greater than zero, the gauge needle is moved to about the one-sixteenth graduation on the gauge scale, the low fuel indicator is illuminated, and a single chime tone is sounded. The low fuel indicator remains illuminated until the fuel level message indicates that the fuel tank is greater than about 14 percent full for 10 consecutive seconds and the vehicle speed is zero, or for 60 consecutive seconds and the vehicle speed is greater than zero, or until the ignition switch is turned to the OFF position, whichever occurs first. The chime tone feature will only repeat during the same ignition cycle if the low fuel indicator is cycled OFF and then ON again by the appropriate messages from the TIPM.
- **Less Than Empty Stop Message** - Each time the cluster receives a fuel level message indicating the fuel level in the fuel tank is less than the **E** (or Empty) gauge needle stop position for five consecutive seconds, the gauge needle is moved to the low end of the gauge scale and the low fuel indicator is illuminated immediately. This input would indicate that the fuel level sense input to the TIPM is a short circuit.
- **More Than Full Stop Message** - Each time the cluster receives a fuel level message indicating the fuel level in the fuel tank is more than the **F** (or Full) gauge needle stop position for five consecutive seconds, the gauge needle is moved to the low end of the gauge scale and the low fuel indicator is illuminated immediately. This input would indicate that the fuel level sense input to the TIPM is an open circuit.
- **Actuator Test** - Each time the cluster is put through the actuator test, the fuel gauge needle will be swept to several calibration points on the gauge scale in a prescribed sequence in order to confirm the functionality of the gauge and the cluster control circuitry.

The TIPM continually monitors the fuel tank sending unit to determine the level of fuel in the fuel tank. The TIPM then sends the proper electronic **fuel level** message to the Electro Mechanical Instrument Cluster (EMIC) (also known as the Cab Compartment Node/CCN) and other electronic modules in the vehicle over the Controller Area Network (CAN) data bus. The TIPM will store a Diagnostic Trouble Code (DTC) for any fault detected in the fuel level sense circuit.

For proper diagnosis of the fuel tank sending unit, the TIPM, the EMIC, the CAN data bus or the electronic communication related to fuel gauge operation or fuel level data processing a diagnostic scan tool is required. Refer to the appropriate diagnostic information.

GAS CAP INDICATOR

DESCRIPTION

GAS CAP INDICATOR

A gas cap indicator is standard equipment on all instrument clusters. However, on vehicles equipped with the optional diesel engine, as well as those manufactured for the Chinese market, this indicator is electronically disabled. The gas cap indication appears within the odometer Vacuum Fluorescent Display (VFD) unit. The gas cap indicator consists of a textual **gas cap** message which appears in place of the odometer information in the odometer display.

The odometer VFD is soldered onto the cluster electronic circuit board, and is visible through a window with a smoked clear lens located on the lower edge of the tachometer gauge dial face of the cluster overlay. The dark lens over the VFD prevents it from being clearly visible when it is not illuminated. The gas cap textual message appears in the same blue-green color and at the same lighting level as the odometer information when it is illuminated by the instrument cluster electronic circuit board.

The gas cap indicator is serviced as a unit with the VFD in the instrument cluster.

OPERATION

GAS CAP INDICATOR

The gas cap indicator gives an indication to the vehicle operator when there is a gross leak detected in the on-board fuel vapor recovery system. This indicator is controlled by the instrument cluster logic circuit based upon cluster programming and electronic messages received over the Controller Area Network (CAN) data bus from the Powertrain Control Module (PCM).

The gas cap indicator function of the odometer Vacuum Fluorescent Display (VFD) unit is completely controlled by the instrument cluster logic circuit, and that logic will only allow this indicator to operate when the instrument cluster receives a battery current input on the fused ignition switch output (run-start) circuit. Therefore, the odometer VFD gas cap indication will always be OFF when the ignition switch is in any position except ON or START. The instrument cluster will turn ON the gas cap indicator for the following reasons:

- **Gas Cap Indicator Lamp-On Message** - Each time the cluster receives an electronic **gas cap indicator lamp-ON** message from the PCM indicating there is a gross leak in the vapor recovery system, the gas cap indicator will be illuminated. The indicator remains illuminated until the cluster receives a lamp-OFF message from the PCM, or until the ignition switch is turned to the OFF position, whichever occurs first.

The PCM continually monitors the on board vapor recovery system to determine whether there are air leaks in the system. The PCM then sends the proper lamp-ON or lamp-OFF message to the Electro Mechanical Instrument Cluster (EMIC) (also known as the Cab Compartment Node/CCN). If the EMIC turns ON the gas cap indicator due to a monitored gross leak in the vapor recovery system, it may indicate that the gas cap has been removed or is improperly installed.

For proper diagnosis of the on board vapor recovery system, the PCM, the EMIC, the CAN data bus or the electronic communication related to gas cap indicator operation a diagnostic scan tool is required. Refer to the appropriate diagnostic information.

GEAR SELECTOR INDICATOR

DESCRIPTION

GEAR SELECTOR INDICATOR



Fig. 21: Gear Selector Indicator
Courtesy of CHRYSLER LLC

An electronic automatic transmission gear selector indicator is standard factory-installed equipment on this vehicle. However, on vehicles not equipped with an optional automatic transmission, this indicator is electronically disabled. The gear selector indicator information is displayed in the upper portion of the odometer Vacuum Fluorescent Display (VFD) unit. This VFD unit is soldered onto the cluster electronic circuit board, and is visible through a window with a smoked clear lens located on the lower edge of the tachometer dial face of the cluster overlay. The dark lens over the VFD unit prevents the indicator from being clearly visible when it is not illuminated.

The gear selector indicator displays the following characters from left to right: **P**, **R**, **N**, **D** and a fifth, reconfigurable character. The reconfigurable character can be any number **1** through **6**. Each character appears in a blue-green color and at the same lighting level as the odometer information. Respectively, these characters represent the PARK, REVERSE, NEUTRAL, DRIVE and each of the forward drive gear positions of the transmission gear selector lever on the floor panel transmission tunnel. The indicator also illuminates a box around the character that represents the currently selected lever position.

During daylight hours (exterior lamps are OFF) the VFD unit is illuminated at full brightness for clear visibility. At night (exterior lamps are ON), the VFD unit lighting level is adjusted with the other cluster general illumination lamps using the panel lamps dimmer function of the interior lighting control sleeve on the left multi-function switch control stalk. However, a PARADE mode position of the control sleeve allows the VFD unit to be illuminated at full brightness if the exterior lamps are turned ON during daylight hours.

The gear selector indicator is serviced as a unit with the VFD unit in the instrument cluster

OPERATION**GEAR SELECTOR INDICATOR**

The electronic gear selector indicator gives an indication to the vehicle operator of the transmission gear that has been selected with the automatic transmission gear selector lever. This indicator is controlled by the instrument cluster circuit board based upon cluster programming and electronic messages received from the Powertrain Control Module (PCM) over the Controller Area Network (CAN) data bus.

The gear selector indicator information is displayed by the odometer Vacuum Fluorescent Display (VFD) unit soldered onto the instrument cluster electronic circuit board, and the VFD will not display the gear selector indicator information after the ignition switch is turned to the OFF position. Each time the cluster is disconnected from battery current for more than about five minutes, it must configure itself for the automatic transmission type that is in the vehicle once it is reconnected to battery current. The instrument cluster circuitry operates the gear selector indicator to provide the following features:

- **Selected Gear Message** - Each time the cluster receives an electronic **selected gear** message from the PCM, a box will be illuminated around the appropriate character in the gear selector indicator. The box will remain illuminated until the cluster receives a different **selected gear** message, or until the ignition switch is turned to the OFF position, whichever occurs first.
- **Communication Error** - If the cluster fails to receive a **selected gear** message from the PCM within three seconds, the instrument cluster circuitry will display all gear selector positions boxed (selected) until a valid **selected gear** message is received or until the ignition switch is turned to the OFF position, whichever occurs first.
- **Actuator Test** - Each time the cluster is put through the actuator test, the odometer VFD unit will display all of its characters at once to confirm the functionality of the VFD unit and the cluster control circuitry.

The PCM continually monitors a hard wired multiplex input from the Transmission Range Sensor (TRS), then sends the proper message to the Electro Mechanical Instrument Cluster (EMIC) (also known as the Cab Compartment Node/CCN).

For proper diagnosis of the TRS, the PCM, the EMIC, the CAN data bus or the electronic communication related to gear selector indicator operation a diagnostic scan tool is required. Refer to the appropriate diagnostic information.

HIGH BEAM INDICATOR**DESCRIPTION****HIGH BEAM INDICATOR**



Fig. 22: High Beam Indicator
Courtesy of CHRYSLER LLC

A high beam indicator is standard equipment on all instrument clusters. This indicator is located near the base of the speedometer needle hub on the cluster overlay, just left of center.

The high beam indicator consists of a stencil-like cutout of the International Control and Display Symbol icon for **High Beam** in the opaque layer of the instrument cluster overlay. The dark outer layer of the overlay prevents the indicator from being clearly visible when it is not illuminated. A blue Light Emitting Diode (LED) behind the cutout in the opaque layer of the overlay causes the indicator to appear in blue through the translucent outer layer of the overlay when it is illuminated from behind by the LED, which is soldered onto the instrument cluster electronic circuit board.

The high beam indicator is serviced as a unit with the instrument cluster.

OPERATION

HIGH BEAM INDICATOR

The high beam indicator gives an indication to the vehicle operator whenever the headlamp high beams are illuminated. This indicator is controlled by a transistor on the instrument cluster circuit board based upon cluster programming and electronic messages received by the cluster from the Totally Integrated Power Module (TIPM) over the Controller Area Network (CAN) data bus.

The high beam indicator Light Emitting Diode (LED) is completely controlled by the instrument cluster logic circuit, and that logic will allow this indicator to operate whenever the instrument cluster receives a battery current input on the fused B(+) circuit. Therefore, the LED can be illuminated regardless of the ignition switch position. The LED only illuminates when it is provided a path to ground by the instrument cluster transistor. The instrument cluster will turn ON the high beam indicator for the following reasons:

- **High Beam Indicator Lamp-On Message** - Each time the cluster receives an electronic **high beam indicator lamp-ON** message from the TIPM indicating the high beam lamps are turned ON, the high beam indicator will be illuminated. The indicator remains illuminated until the cluster receives a lamp-OFF message from the TIPM, or until the exterior lamp load shedding (battery saver) timed interval expires, whichever occurs first.
- **Actuator Test** - Each time the cluster is put through the actuator test, the high beam indicator will be

turned ON, then OFF again during the bulb check portion of the test to confirm the functionality of the LED and the cluster control circuitry.

The TIPM continually monitors electronic **exterior lighting request** messages from the Electro Mechanical Instrument Cluster (EMIC) (also known as the Cab Compartment Node/CCN) to determine the appropriate outputs to the headlamps. The TIPM activates or deactivates the headlamp high beams then sends the proper lamp-ON or lamp-OFF message back to the EMIC.

For proper diagnosis of the headlamp system, the TIPM, the EMIC, the CAN data bus or the electronic communication related to high beam indicator operation a diagnostic scan tool is required. Refer to the appropriate diagnostic information.

INSTRUMENT PANEL SWITCH POD

DESCRIPTION

INSTRUMENT PANEL SWITCH POD

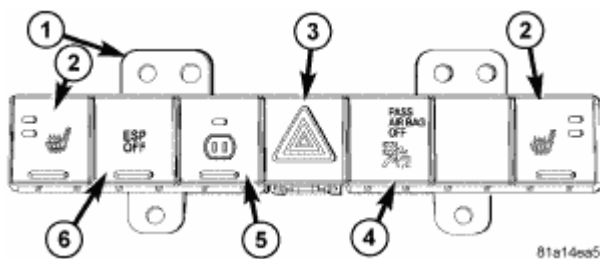

Fig. 23: Identifying Occupant Classification System Switches & Indicators
Courtesy of CHRYSLER LLC

The instrument panel switch pod (1) is located just below the heater and air conditioner controls in the center stack area of the instrument panel. This switch is available in multiple configurations, which varies from two single push button switches to as many as five push button switches and an indicator lamp, depending upon the optional equipment in the vehicle. The pod may include the following switches or indicators:

- **Alternating Current (AC) Power Inverter Outlet Switch (5)**
- **Driver and Passenger Side Heated Seat Switches (2)**
- **Hazard Warning Switch (3)**
- **Headlamp Leveling Switch (Not Shown)**
- **Park Assist Switch (Not Shown)**
- **Passenger Airbag On/Off Indicator (4)**
- **Electronic Stability Program (ESP) Switch (6)**

The switch housing and the push buttons are constructed of molded plastic. Each push button has a smooth finish and is clearly identified with the appropriate text and International Control and Display Symbol icons. Several of the push buttons feature Light Emitting Diode (LED) units to give the vehicle operator an indication when the function of that switch is currently active. Only the hazard warning switch push button latches, while

2007 Dodge Nitro R/T

2007 ACCESSORIES AND EQUIPMENT Instrument Cluster - Service Information - Nitro

the remaining switches feature momentary operation.

Four screws secure the switch to the back of the instrument panel center bezel through integral mounting tabs that are molded into each corner of the switch housing. The back of the switch housing has an integral connector receptacle containing terminal pins that connect the switch to the vehicle electrical system through a dedicated take out and connector of the instrument panel wire harness.

Panel lamps dimmer controlled illumination lamps integral to the circuit board within the switch provide back lighting for visibility at night, but these lamps are not serviceable. The individual switches in the instrument panel switch pod cannot be repaired and are not serviced separately. If any component within the switch pod is ineffective or damaged, the entire switch pod unit must be replaced.

OPERATION

INSTRUMENT PANEL SWITCH POD

For information covering details of operation for the individual switches or indicator contained within the instrument panel switch pod, refer to the specific service information covering the system to which that switch or indicator belongs.

REMOVAL

INSTRUMENT PANEL SWITCH POD

WARNING: To avoid serious or fatal injury on vehicles equipped with airbags, disable the Supplemental Restraint System (SRS) before attempting any steering wheel, steering column, airbag, Occupant Classification System (OCS), seat belt tensioner, impact sensor, or instrument panel component diagnosis or service. Disconnect and isolate the battery negative (ground) cable, then wait two minutes for the system capacitor to discharge before performing further diagnosis or service. This is the only sure way to disable the SRS. Failure to take the proper precautions could result in accidental airbag deployment.

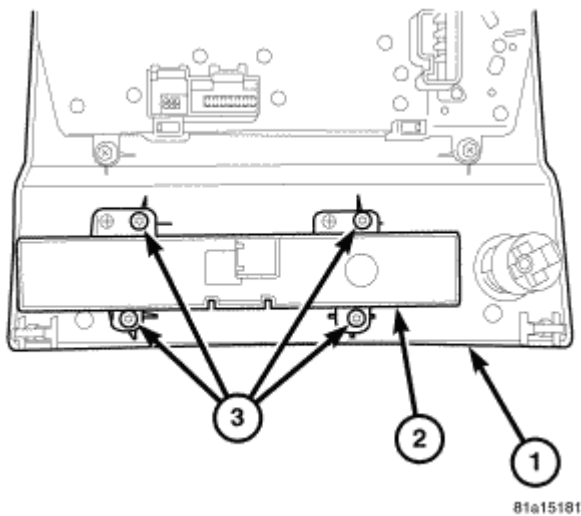

Fig. 24: Identifying Center Bezel, Instrument Panel Switch Pod & Screws
Courtesy of CHRYSLER LLC

1. Disconnect and isolate the battery negative cable.
2. Remove the center bezel (1) from the instrument panel. Refer to **REMOVAL**.
3. Disconnect the wire harness connector from the back of the instrument panel switch pod (2).
4. Remove the four screws (3) that secure the switch pod to the back of the center bezel.
5. Remove the switch pod from the center bezel.

INSTALLATION

INSTRUMENT PANEL SWITCH POD

WARNING: To avoid serious or fatal injury on vehicles equipped with airbags, disable the Supplemental Restraint System (SRS) before attempting any steering wheel, steering column, airbag, Occupant Classification System (OCS), seat belt tensioner, impact sensor, or instrument panel component diagnosis or service. Disconnect and isolate the battery negative (ground) cable, then wait two minutes for the system capacitor to discharge before performing further diagnosis or service. This is the only sure way to disable the SRS. Failure to take the proper precautions could result in accidental airbag deployment.

NOTE: There are several different instrument panel switch pods available, depending upon the optional equipment content of the vehicle. Be certain that a replacement switch pod matches the optional equipment of the vehicle into which it is being installed.

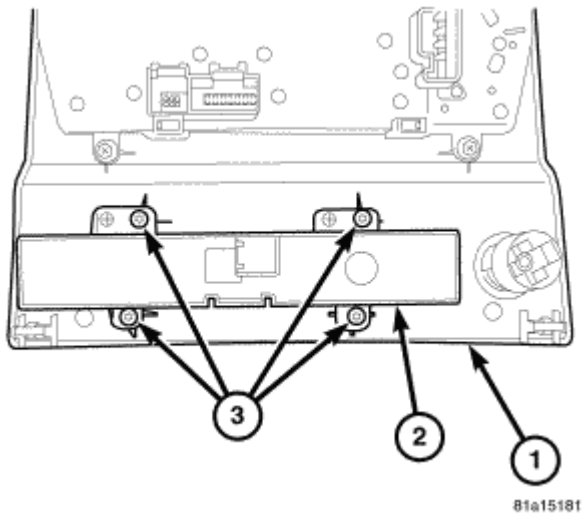

Fig. 25: Identifying Center Bezel, Instrument Panel Switch Pod & Screws
Courtesy of CHRYSLER LLC

1. Position the instrument panel switch pod (2) to the back of the center bezel (1).
2. Install and tighten the four screws (3) that secure the switch pod to the center bezel. Tighten the screws to 2 N.m (17 in. lbs.).
3. Reconnect the wire harness connector to the back of the switch pod.
4. Reinstall the center bezel onto the instrument panel. Refer to **INSTALLATION** .
5. Reconnect the battery negative cable.

LOW FUEL INDICATOR

DESCRIPTION

LOW FUEL INDICATOR



Fig. 26: Identifying Low Fuel Indicator
Courtesy of CHRYSLER LLC

A low fuel indicator is standard equipment on all instrument clusters. The low fuel indicator is located above the fuel gauge needle hub on the cluster overlay, to the left of the speedometer.

The low fuel indicator consists of a stencil-like cutout of the International Control and Display Symbol icon for **Fuel** in the opaque layer of the instrument cluster overlay. The dark outer layer of the overlay prevents the indicator from being clearly visible when it is not illuminated. An amber Light Emitting Diode (LED) behind the cutout in the opaque layer of the overlay causes the indicator to appear in amber through the translucent outer layer of the overlay when it is illuminated from behind by the LED, which is soldered onto the instrument cluster electronic circuit board.

The low fuel indicator is serviced as a unit with the instrument cluster.

OPERATION

LOW FUEL INDICATOR

The low fuel indicator gives an indication to the vehicle operator when the level of fuel in the fuel tank becomes low. This indicator is controlled by a transistor on the instrument cluster circuit board based upon cluster programming and electronic **fuel level** messages received by the cluster from the Totally Integrated Power Module (TIPM) over the Controller Area Network (CAN) data bus.

The low fuel indicator Light Emitting Diode (LED) is completely controlled by the instrument cluster logic circuit, and that logic will only allow this indicator to operate when the instrument cluster receives a battery current input on the fused ignition switch output (run-start) circuit. Therefore, the LED will always be OFF when the ignition switch is in any position except ON or START. The LED only illuminates when it is provided a path to ground by the instrument cluster transistor. The instrument cluster will turn ON the low fuel indicator for the following reasons:

- **Bulb Test** - Each time the ignition switch is turned to the ON position the low fuel indicator is illuminated for about three seconds as a bulb test.
- **Less Than 11 Percent Tank Full Message** - The TIPM provides a constant current source to the fuel level sending unit and monitors a return input on a fuel level sense circuit. The resistance through the fuel level sending unit increases as the fuel level rises and decreases as the fuel level falls causing changes in the fuel level sense input voltage. The TIPM then sends the appropriate electronic **fuel level** messages to the cluster. Each time the fuel level messages to the cluster indicate the fuel tank is about 11 percent full or less for 10 consecutive seconds and the vehicle speed is zero, or for 60 consecutive seconds and the vehicle speed is greater than zero, the gauge needle is moved to the appropriate position on the gauge scale, the low fuel indicator is illuminated, and a single chime tone is sounded. The low fuel indicator remains illuminated until the fuel level messages indicate that the fuel tank is greater than about 14 percent full for 10 consecutive seconds and the vehicle speed is zero, or for 60 consecutive seconds and the vehicle speed is greater than zero, or until the ignition switch is turned to the OFF position, whichever occurs first. The chime tone feature will only repeat during the same ignition cycle if the low fuel indicator is cycled OFF and then ON again by the appropriate messages from the TIPM.
- **Less Than Empty Stop Message** - Each time the cluster receives a fuel level message indicating the fuel level in the fuel tank is less than the **E** (or Empty) gauge needle stop position for five consecutive seconds, the gauge needle is moved to the low end of the gauge scale and the low fuel indicator is illuminated immediately. This input would indicate that the fuel level sense input to the TIPM is a short

circuit.

- **More Than Full Stop Message** - Each time the cluster receives a fuel level message indicating the fuel level in the fuel tank is more than the **F** (or Full) gauge needle stop position for five consecutive seconds, the gauge needle is moved to the low end of the gauge scale and the low fuel indicator is illuminated immediately. This input would indicate that the fuel level sense input to the TIPM is an open circuit.

The TIPM continually monitors the fuel tank sending unit to determine the level of fuel in the fuel tank. The TIPM then sends the proper electronic **fuel level** message to the Electro Mechanical Instrument Cluster (EMIC) (also known as the Cab Compartment Node/CCN) and other electronic modules in the vehicle over the Controller Area Network (CAN) data bus. The TIPM will store a Diagnostic Trouble Code (DTC) for any fault detected in the fuel level sense circuit.

For proper diagnosis of the fuel tank sending unit, the TIPM, the EMIC, the CAN data bus or the electronic communication related to low fuel indicator operation or fuel level data processing a diagnostic scan tool is required. Refer to the appropriate diagnostic information.

LOW OIL PRESSURE INDICATOR

DESCRIPTION

LOW OIL PRESSURE INDICATOR



Fig. 27: Low Oil Pressure Indicator
Courtesy of CHRYSLER LLC

A low oil pressure indicator is standard equipment on all instrument clusters. This indicator is located near the bottom of the speedometer dial face of the cluster overlay, just left of center.

The low oil pressure indicator consists of a stencil-like cutout of the International Control and Display Symbol icon for **Engine Oil** in the opaque layer of the instrument cluster overlay. The dark outer layer of the overlay prevents the indicator from being clearly visible when it is not illuminated. A red Light Emitting Diode (LED) behind the cutout in the opaque layer of the overlay causes the indicator to appear in red through the translucent outer layer of the overlay when it is illuminated from behind by the LED, which is soldered onto the instrument cluster electronic circuit board.

The low oil pressure indicator is serviced as a unit with the instrument cluster.

OPERATION

LOW OIL PRESSURE INDICATOR

2007 Dodge Nitro R/T

2007 ACCESSORIES AND EQUIPMENT Instrument Cluster - Service Information - Nitro

The low oil pressure indicator gives an indication to the vehicle operator when the engine oil pressure reading reflects a condition requiring immediate attention. This indicator is controlled by a transistor on the instrument cluster circuit board based upon cluster programming and electronic messages received by the cluster from the Powertrain Control Module (PCM) over the Controller Area Network (CAN) data bus.

The low oil pressure indicator Light Emitting Diode (LED) is completely controlled by the instrument cluster logic circuit, and that logic will only allow this indicator to operate when the instrument cluster receives a battery current input on the fused ignition switch output (run-start) circuit. Therefore, the LED will always be OFF when the ignition switch is in any position except ON or START. The LED only illuminates when it is provided a path to ground by the instrument cluster transistor. The instrument cluster will turn ON the low oil pressure indicator for the following reasons:

- **Engine Oil Pressure Low Message** - Each time the cluster receives an electronic **engine oil pressure** message from the PCM indicating the pressure is about 6.9 kPa (1 psi) or lower, the low oil pressure indicator will be illuminated. The indicator can be flashed ON and OFF, or illuminated solid, as dictated by the PCM message. The indicator remains illuminated solid or flashing until the cluster receives a message from the PCM indicating that the pressure is above about 6.9 kPa (1 psi), or until the ignition switch is turned to the OFF position, whichever occurs first. The cluster will only turn the indicator ON in response to low engine oil pressure if the engine speed is greater than zero.
- **Actuator Test** - Each time the cluster is put through the actuator test, the low oil pressure indicator will be turned ON, then OFF again during the bulb check portion of the test to confirm the functionality of the LED and the cluster control circuitry.

The PCM continually monitors the engine oil pressure sensor to determine the engine oil pressure. The PCM then sends the proper messages to the Electro Mechanical Instrument Cluster (EMIC) (also known as the Cab Compartment Node/CCN). If the EMIC turns ON the indicator after the bulb test, it may indicate that the engine or the engine oiling system requires service.

For proper diagnosis of the engine oil pressure sensor, the PCM, the EMIC, the CAN data bus or the electronic communication related to low oil pressure indicator operation a diagnostic scan tool is required. Refer to the appropriate diagnostic information.

MALFUNCTION INDICATOR LAMP (MIL)

DESCRIPTION

MALFUNCTION INDICATOR

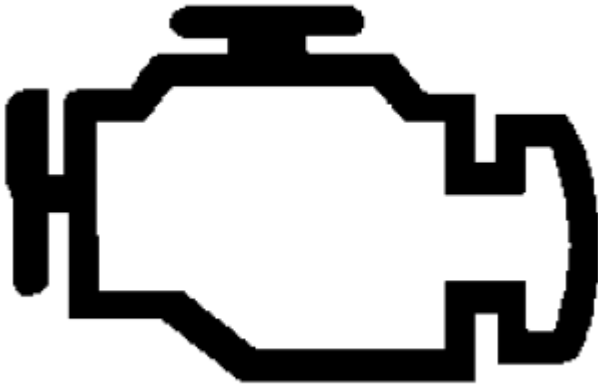

Fig. 28: Malfunction Indicator Lamp
Courtesy of CHRYSLER LLC

A Malfunction Indicator Lamp (MIL) is standard equipment on all instrument clusters. This indicator is located within the odometer Vacuum Fluorescent Display (VFD) unit.

The MIL indicator consists of the International Control and Display Symbol icon for **Engine** in the VFD display. The odometer VFD unit is soldered onto the cluster electronic circuit board, and is visible through a window with a smoked clear lens located on the lower edge of the tachometer dial face of the cluster overlay. The dark lens over the VFD unit prevents the indicator from being clearly visible when it is not illuminated. The MIL icon appears in an amber color when it is illuminated by the cluster electronic circuit board, and the MIL as well as all of the odometer VFD information is illuminated at full (daytime) brightness and cannot be dimmed until the MIL is extinguished.

The MIL is serviced as a unit with the VFD unit in the instrument cluster.

OPERATION

MALFUNCTION INDICATOR

The Malfunction Indicator Lamp (MIL) gives an indication to the vehicle operator when the Powertrain Control Module (PCM) has recorded a Diagnostic Trouble Code (DTC) for an On-Board Diagnostics II (OBDII) emissions-related circuit or component malfunction. The MIL is controlled by the instrument cluster circuit board based upon cluster programming and electronic messages received by the cluster from the PCM over the Controller Area Network (CAN) data bus.

The MIL is completely controlled by the instrument cluster logic circuit, and that logic will only allow this indicator to operate when the instrument cluster receives a battery current input on the fused ignition switch output (run-start) circuit. Therefore, the indicator will always be OFF when the ignition switch is in any position except ON or START. The indicator only illuminates when it is energized by the instrument cluster logic circuit. The instrument cluster will turn ON the MIL for the following reasons:

2007 Dodge Nitro R/T

2007 ACCESSORIES AND EQUIPMENT Instrument Cluster - Service Information - Nitro

- **Bulb Test** - Each time the ignition switch is turned to the ON position the indicator is illuminated for about 15 seconds as a bulb test. The entire bulb test is a function of the PCM.
- **MIL Lamp-On Message** - Each time the cluster receives an electronic **MIL lamp-ON** message from the PCM, the indicator will be illuminated. The indicator can be flashed ON and OFF, or illuminated solid, as dictated by the PCM message. For some DTCs, if a problem does not recur, the PCM will send a lamp-OFF message automatically. Other DTCs may require that a fault be repaired and the PCM be reset before a lamp-OFF message will be sent. For more information on the PCM, and the DTC set and reset parameters, refer to **EMISSIONS CONTROL** .
- **Communication Error** - If the cluster receives no lamp-ON or lamp-OFF messages from the PCM for 10 consecutive message cycles, the MIL is illuminated by the instrument cluster to indicate a loss of bus communication. The indicator remains controlled and illuminated by the cluster until a valid message is received from the PCM.
- **Actuator Test** - Each time the cluster is put through the actuator test, the MIL indicator will be turned ON, then OFF again during the odometer VFD portion of the test in order to confirm the functionality of the VFD and the cluster control circuitry.

The PCM continually monitors the fuel and emissions system circuits and sensors to decide whether the system is in good operating condition. The PCM then sends the proper lamp-ON or lamp-OFF message to the Electro Mechanical Instrument Cluster (EMIC) (also known as the Cab Compartment Node/CCN). If the EMIC turns ON the MIL after the bulb test, it may indicate that a malfunction has occurred and that the fuel and emissions systems require service.

For proper diagnosis of the fuel and emissions systems, the PCM, the EMIC, the CAN data bus or the electronic communication related to MIL operation a diagnostic scan tool is required. Refer to the appropriate diagnostic information.

ODOMETER

DESCRIPTION

ODOMETER/TRIP ODOMETER



Fig. 29: Odometer/Trip Odometer
 Courtesy of CHRYSLER LLC

An odometer and trip odometer are standard factory-installed equipment in all instrument clusters. The odometer and trip odometer are displayed in a common electronic, blue-green Vacuum-Fluorescent Display (VFD) unit. This VFD unit is soldered onto the cluster electronic circuit board, and is visible through a window with a smoked clear lens located on the lower edge of the tachometer in the lower right area of the cluster overlay. The dark lens over the VFD prevents the indicator from being clearly visible when it is not illuminated.

The odometer and trip odometer information are not displayed simultaneously. The trip odometer reset switch on the instrument cluster circuit board toggles the display between odometer and trip odometer modes by depressing the odometer/trip odometer switch button that extends through the lower edge of the cluster lens, just left of the minor gauge set. When the trip odometer information is displayed, the text **TRIP A** or **TRIP B** is also illuminated in the lower right corner of the odometer/trip odometer VFD in a blue-green color and at the same lighting level as the trip odometer information.

The odometer and trip odometer information are stored in the instrument cluster memory. This information can be increased when the proper inputs are provided to the instrument cluster, but the information cannot be decreased. The odometer can display values up to 999,999 kilometers (999,999 miles). The odometer latches at these values, and will not roll over to zero. The trip odometer can display values up to 999.9 kilometers (999.9 miles) before it rolls over to zero.

The odometer display does not show leading zeroes, does not have a decimal point and will not show values less than a full unit (kilometer or mile). The unit of measure (**km** or **miles**) for the odometer display is not shown in the VFD. The unit of measure for the instrument cluster odometer/trip odometer is selected at the time that it is manufactured, and cannot be changed. The odometer has a RENTAL CAR mode, which will illuminate the odometer information in the VFD whenever the driver side front door is opened with the ignition switch in the OFF or ACCESSORY positions.

During daylight hours (exterior lamps are OFF) the odometer VFD is illuminated at full brightness for clear

visibility. At night (exterior lamps are ON), the VFD lighting level is adjusted with the other cluster general illumination lamps using the panel lamps dimmer function of the interior lighting control sleeve on the left multi-function switch control stalk. However, a PARADE mode position of the control sleeve allows the VFD to be illuminated at full brightness if the exterior lamps are turned ON during daylight hours. On vehicles manufactured for domestic markets, the odometer VFD is also illuminated at full brightness whenever the Malfunction Indicator Lamp (MIL) or the Tire Pressure Monitor (TPM) indicator is illuminated, and cannot be dimmed until the MIL or TPM indicator is extinguished.

The odometer/trip odometer VFD, the trip odometer switch and the trip odometer push button are serviced as a unit with the instrument cluster.

OPERATION

ODOMETER/TRIP ODOMETER

The odometer and trip odometer give an indication to the vehicle operator of the distance the vehicle has traveled. This indicator is controlled by the instrument cluster circuitry based upon cluster programming and electronic messages received by the cluster from the Powertrain Control Module (PCM) over the Controller Area Network (CAN) data bus.

The odometer and trip odometer information is displayed by the instrument cluster odometer/trip odometer Vacuum Fluorescent Display (VFD). The VFD will display the odometer information whenever the driver side front door is opened with the ignition switch in the OFF or ACCESSORY positions. The instrument cluster circuitry controls the VFD and provides the following features:

- **Odometer/Trip Odometer Display Toggling** - Actuating the trip odometer reset switch button momentarily with the VFD illuminated will toggle the display between the odometer and trip odometer A and B information. Each time the VFD is illuminated with the ignition switch in the ON or START positions, the display will automatically return to the last mode previously selected (odometer or trip odometer).
- **Trip Odometer Reset** - When the trip odometer reset switch button is pressed and held for longer than about two seconds with the ignition switch in the ON or START positions, the trip odometer will be reset to **0.0** kilometers (miles). The VFD must be displaying the trip odometer information in order for the trip odometer information to be reset.
- **Gas Cap Message Display** - On vehicles manufactured with a United States country code, each time the cluster receives an electronic message from the PCM indicating a monitored leak in the evaporative emissions system, the cluster replaces the displayed odometer/trip odometer value with the textual message, **gas cap** . This message serves as a reminder to the vehicle operator to check that the gas cap is properly installed and tightened, but could also indicate another source of air leakage in the on-board evaporative and vapor recovery emissions systems. Unless the leak is corrected, this message will latch and remain displayed during the current and each subsequent ignition cycle until the trip odometer reset button is pressed and released momentarily, which will revert the display to the odometer/trip odometer information that was last displayed for the remainder of that ignition cycle. Once the source of a leak has been corrected, either momentarily pressing the trip odometer reset button or cycling the ignition switch will unlatch the message and return the odometer/trip odometer to normal operation.
- **Communication Error** - If the cluster fails to receive an electronic **distance** message during normal operation, it will hold and display the last data received until the ignition switch is turned to the OFF

position. If the cluster does not receive a **distance** message within one second after the ignition switch is turned to the ON position, it will display the last distance value stored in the cluster memory. If the cluster is unable to display odometer information due to an error internal to the cluster, the VFD will display **error** .

- **Actuator Test** - Each time the cluster is put through the actuator test, the odometer VFD will display all of its segments simultaneously during the VFD portion of the test to confirm the functionality of the VFD and the cluster control circuitry.

The PCM continually monitors the vehicle speed pulse information received from the wheel speed sensors, then sends the proper messages to the Electro Mechanical Instrument Cluster (EMIC) (also known as the Cab Compartment Node/CCN).

For proper diagnosis of the wheel speed sensors, the PCM, the EMIC, the CAN data bus or the electronic communication related to odometer/trip odometer operation a diagnostic scan tool is required. Refer to the appropriate diagnostic information.

REAR FOG LAMP INDICATOR

DESCRIPTION

REAR FOG LAMP INDICATOR

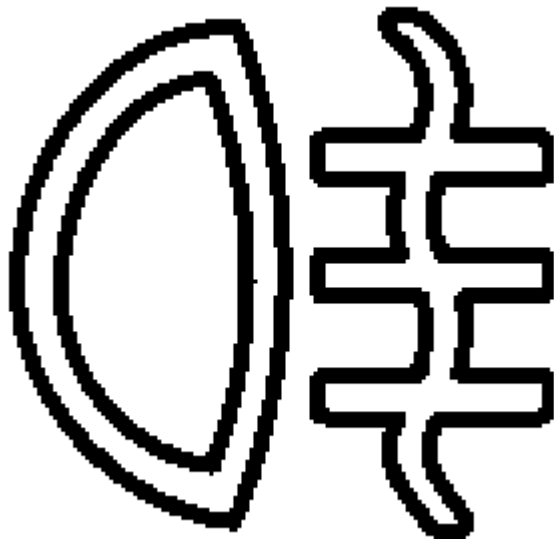

Fig. 30: Rear Fog Lamp Indicator
Courtesy of CHRYSLER LLC

A rear fog lamp indicator is standard equipment on all instrument clusters for certain markets where rear fog lamps are available. However, on vehicles not equipped with the optional rear fog lamps, this indicator is electronically disabled. This indicator is located near the bottom of the speedometer dial face of the cluster overlay, just right of center.

The rear fog lamp indicator consists of a stencil-like cutout of the International Control and Display Symbol icon for **Rear Fog Light** in the opaque layer of the instrument cluster overlay. The dark outer layer of the overlay prevents the indicator from being clearly visible when it is not illuminated. An amber Light Emitting Diode (LED) behind the cutout in the opaque layer of the overlay causes the indicator to appear in amber through the translucent outer layer of the overlay when it is illuminated from behind by the LED, which is soldered onto the instrument cluster electronic circuit board.

The rear fog lamp indicator is serviced as a unit with the instrument cluster.

OPERATION

REAR FOG LAMP INDICATOR

The rear fog lamp indicator gives an indication to the vehicle operator whenever the rear fog lamps are illuminated. This indicator is controlled by a transistor on the instrument cluster circuit board based upon cluster programming and electronic messages received by the cluster from the Totally Integrated Power Module (TIPM) over the Controller Area Network (CAN) data bus.

The rear fog lamp indicator Light Emitting Diode (LED) is completely controlled by the instrument cluster logic circuit, and that logic will allow this indicator to operate whenever the instrument cluster receives a battery current input on the fused B(+) circuit. Therefore, the LED can be illuminated regardless of the ignition switch position. The LED only illuminates when it is provided a path to ground by the instrument cluster transistor. The instrument cluster will turn ON the rear fog lamp indicator for the following reasons:

- **Rear Fog Indicator Lamp-On Message** - Each time the cluster receives an electronic **rear fog indicator lamp-ON** message from the TIPM indicating the rear fog lamps are turned ON, the rear fog lamp indicator will be illuminated. The indicator remains illuminated until the cluster receives a lamp-OFF message from the TIPM, or until the exterior lamp load shedding (battery saver) timed interval expires, whichever occurs first.
- **Actuator Test** - Each time the cluster is put through the actuator test, the rear fog lamp indicator will be turned ON, then OFF again during the bulb check portion of the test to confirm the functionality of the LED and the cluster control circuitry.

The TIPM continually monitors electronic **exterior lighting request** messages from the Electro Mechanical Instrument Cluster (EMIC) (also known as the Cab Compartment Node/CCN) to determine the appropriate outputs to the rear fog lamps. The TIPM activates or deactivates the rear fog lamps then sends the proper lamp-ON or lamp-OFF message back to the EMIC.

For proper diagnosis of the rear fog lamp system, the TIPM, the EMIC, the CAN data bus or the electronic communication related to rear fog lamp indicator operation a diagnostic scan tool is required. Refer to the appropriate diagnostic information.

SEATBELT INDICATOR

DESCRIPTION

SEATBELT INDICATOR



Fig. 31: Seatbelt Indicator
Courtesy of CHRYSLER LLC

A seatbelt indicator is standard equipment on all instrument clusters. This indicator is located near the top of the cluster overlay, between the fuel gauge and the engine temperature gauge.

The seatbelt indicator consists of a stencil-like cutout of the International Control and Display Symbol icon for **Seat Belt** in the opaque layer of the instrument cluster overlay. The dark outer layer of the overlay prevents the indicator from being clearly visible when it is not illuminated. A red Light Emitting Diode (LED) behind the cutout in the opaque layer of the overlay causes the indicator to appear in red through the translucent outer layer of the overlay when it is illuminated from behind by the LED, which is soldered onto the instrument cluster electronic circuit board.

The seatbelt indicator is serviced as a unit with the instrument cluster.

OPERATION

SEATBELT INDICATOR

The seatbelt indicator gives an indication to the vehicle operator of the status of the driver side front seat belt. This indicator is controlled by a transistor on the instrument cluster circuit board based upon cluster programming and a hard wired input from the seatbelt switch on the driver side front seat belt retractor through the seat belt switch sense circuits.

The seatbelt indicator also includes a programmable enhanced seatbelt reminder or BELTMINDER feature that is enabled when the vehicle is shipped from the factory. This BELTMINDER feature can be disabled and enabled by the customer using a specific programming event sequence, or by the dealer using a diagnostic scan

tool.

The seatbelt indicator Light Emitting Diode (LED) is completely controlled by the instrument cluster logic circuit, and that logic will only allow this indicator to operate when the instrument cluster receives a battery current input on the fused ignition switch output (run-start) circuit. Therefore, the LED will always be OFF when the ignition switch is in any position except ON or START. The LED only illuminates when it is provided a path to ground by the instrument cluster transistor. The instrument cluster will turn ON the seatbelt indicator for the following reasons:

- **Seatbelt Reminder Function** - Each time the cluster receives a battery current input on the fused ignition switch output (run-start) circuit, the indicator will be illuminated as a seatbelt reminder for about six seconds, or until the ignition switch is turned to the OFF position, whichever occurs first. This reminder function will occur regardless of the status of the seatbelt switch inputs to the cluster.
- **Front Seatbelt Not Buckled - Beltminder Active** - Following the seatbelt reminder function, each time the cluster detects an open circuit on the front seat belt switch sense circuit (seatbelt switch open = seatbelt unbuckled) with the ignition switch in the START or ON positions, the indicator will be illuminated. In addition, if the front seat belt remains unbuckled about 4 seconds after the conclusion of the seatbelt reminder function, the seatbelt indicator will begin to cycle between flashing ON and OFF for 3 seconds, then lighting solid for 2 seconds. The seatbelt indicator will continue to cycle between flashing and solid illumination for 13 complete cycles, until the seat belt switch sense input to the cluster is a closed circuit to ground (seatbelt switch closed = seatbelt buckled), or until the ignition switch is turned to the OFF position, whichever occurs first.
- **Front Seatbelt Not Buckled - Beltminder Inactive** - Following the seatbelt reminder function, each time the cluster detects an open circuit on the seat belt switch sense circuit (seatbelt switch open = seatbelt unbuckled) with the ignition switch in the START or ON positions, the indicator will be illuminated. The seatbelt indicator remains illuminated until the seat belt indicator input to the cluster is a closed circuit to ground (seatbelt switch closed = seatbelt buckled), or until the ignition switch is turned to the OFF position, whichever occurs first.
- **Actuator Test** - Each time the cluster is put through the actuator test, the seatbelt indicator will be turned ON, then OFF again during the bulb check portion of the test to confirm the functionality of the LED and the cluster control circuitry.

The seatbelt switch is connected in series between ground and the seat belt switch sense circuit input to the Electro Mechanical Instrument Cluster (EMIC) (also known as the Cab Compartment Node/CCN). The seatbelt switch input to the instrument cluster circuitry may be diagnosed using conventional diagnostic tools and procedures. Refer to the appropriate wiring information.

STANDARD PROCEDURE

ENHANCED SEATBELT REMINDER PROGRAMMING

The seatbelt indicator also includes a programmable enhanced seatbelt reminder or BELTMINDER feature that is enabled when the vehicle is shipped from the factory. This BELTMINDER feature provides extended and modified visual seatbelt indicator and audible chime warning responses to an unbuckled driver side front seat belt. The BELTMINDER feature may be disabled or enabled by the customer using the programming sequence that follows, or by the dealer using a diagnostic scan tool.

CUSTOMER PROGRAMMING SEQUENCE

NOTE: The following sequence of events must occur within 60 seconds of the ignition switch being placed in the ON position in order for the programming to be completed successfully.

1. With all doors closed and the ignition switch in any position except ON or START, buckle the driver side front seat belt.
2. Turn the ignition switch to the ON position and wait for the seatbelt indicator reminder function to conclude (about six seconds).
3. Unbuckle and buckle the driver side front seat belt three or more times, ending with the belt buckled.
4. Turn the ignition switch to any position except ON or START to toggle the BELTMINDER feature from its current setting (from active to inactive, or from inactive to active). A single chime tone will provide an audible confirmation that the programming sequence has been successfully completed.

SECURITY INDICATOR

DESCRIPTION

SECURITY INDICATOR

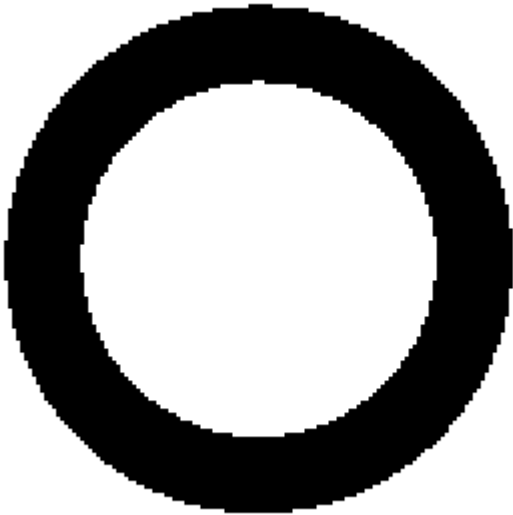

Fig. 32: Security Indicator
Courtesy of CHRYSLER LLC

A security indicator is standard equipment on all instrument clusters. However, on vehicles not equipped with the optional Vehicle Theft Security System (VTSS), this indicator is electronically disabled. This indicator is located near the base of the speedometer needle hub on the cluster overlay, just left of center.

The security indicator consists of a small round cutout in the opaque layer of the instrument cluster overlay. The

dark outer layer of the overlay prevents the indicator from being clearly visible when it is not illuminated. A red Light Emitting Diode (LED) behind the cutout in the opaque layer of the overlay causes the indicator to appear in red through the translucent outer layer of the overlay when it is illuminated from behind by the LED, which is soldered onto the instrument cluster electronic circuit board.

The security indicator is serviced as a unit with the instrument cluster.

OPERATION

SECURITY INDICATOR

The security indicator gives an indication to the vehicle operator when the Vehicle Theft Security System (VTSS) is arming or is armed. On vehicles equipped with the Sentry Key Immobilizer System (SKIS), the security indicator also gives an indication to the vehicle operator of the status of the SKIS. This indicator is controlled by a transistor on the instrument cluster circuit board based upon cluster programming, and electronic **security indicator request** messages received by the cluster from the Totally Integrated Power Module (TIPM) or the Sentry Key REMote Entry Module (SKREEM) (also known as the Wireless Control Module/WCM) over the Controller Area Network (CAN) data bus.

The security indicator Light Emitting Diode (LED) is completely controlled by the instrument cluster logic circuit, and that logic will allow this indicator to operate whenever the instrument cluster receives a battery current input on the fused B(+) circuit. Therefore, the LED can be illuminated regardless of the ignition switch position. The LED only illuminates when it is provided a path to ground by the instrument cluster transistor. Depending upon the programmed condition, the indicator can be illuminated solid, flashed at a slow rate (0.5 Hertz, 12.5 percent duty cycle), or flashed at a fast rate (1 Hertz, 50 percent duty cycle). The instrument cluster will turn ON the security indicator for the following reasons:

- **Bulb Test** - Each time the ignition switch is turned to the ON position the security indicator illuminates for about two seconds as a bulb test. The entire bulb test is a function of the SKREEM.
- **Security Indicator Lamp-On Message** - During the 16 second VTSS arming function, the TIPM will request the cluster flash the security indicator ON and OFF repeatedly at a steady, fast rate to indicate that the VTSS is in the process of arming. Following successful VTSS arming, the TIPM will request the cluster flash the security indicator ON and OFF continuously at a slower rate to indicate that the VTSS is armed. The security indicator continues flashing at the slower rate until the VTSS is disarmed or triggered. If the VTSS has alarmed and rearmed, the TIPM will request the cluster flash the security indicator at a steady, slow rate for about 30 seconds after the VTSS is disarmed.
- **SKIS Indicator Lamp-On Message** - Each time the cluster receives an electronic **SKIS indicator lamp-ON** message from the SKREEM, the security indicator will be illuminated. The indicator can be flashed ON and OFF, or illuminated solid, as dictated by the SKREEM message. The indicator remains illuminated solid or continues to flash until the cluster receives a lamp-OFF message from the SKREEM, or until the ignition switch is turned to the OFF position, whichever occurs first. For more information on the SKIS and the security indicator control parameters, refer to **OPERATION** .
- **Communication Error** - If the cluster receives no lamp-ON or lamp-OFF messages from the TIPM or the SKREEM for 10 consecutive message cycles, the security indicator is illuminated by the instrument cluster. The indicator remains controlled and illuminated by the cluster until a valid lamp-ON or lamp-OFF message is received from the SKREEM.
- **Actuator Test** - Each time the instrument cluster is put through the actuator test, the security indicator

will be turned ON, then OFF again during the bulb check portion of the test to confirm the functionality of the LED and the cluster control circuitry.

The TIPM sends electronic **security indicator request** messages to control the security indicator whenever the ignition switch is in the OFF position and the VTSS is arming, armed, or alarming. Whenever the ignition switch is in the ON or START positions, the SKREEM performs a self-test to decide whether the SKIS is in good operating condition and whether a valid key is present in the ignition lock cylinder. The SKREEM then sends the proper lamp-ON or lamp-OFF message to the Electro Mechanical Instrument Cluster (EMIC) (also known as the Cab Compartment Node/CCN). If the cluster flashes the security indicator upon ignition ON, or turns ON the security indicator solid after the bulb test, it indicates that a SKIS malfunction has occurred or that the SKIS is ineffective.

For proper diagnosis of the VTSS, the SKIS, the SKREEM, the TIPM, the EMIC, the CAN data bus or the electronic communication related to security indicator operation a diagnostic scan tool is required. Refer to the appropriate diagnostic information.

SERVICE 4WD INDICATOR

DESCRIPTION

SERVICE 4WD INDICATOR

The image shows the Service 4WD indicator symbol, which consists of the words "SERV" and "4WD" stacked vertically in a large, bold, sans-serif font.

Fig. 33: Service 4WD Indicator
Courtesy of CHRYSLER LLC

A service 4WD indicator is standard equipment on all instrument clusters. However, on vehicles not equipped with the optional four-wheel drive system and electronically shifted transfer case, this indicator is electronically disabled. This indicator is located near the bottom of the speedometer dial face of the cluster overlay, just left of center.

The service 4WD indicator consists of a stencil-like cutout of the text **SERV 4WD** in the opaque layer of the instrument cluster overlay. The dark outer layer of the overlay prevents the indicator from being clearly visible when it is not illuminated. An amber Light Emitting Diode (LED) behind the cutout in the opaque layer of the overlay causes the indicator to appear in amber through the translucent outer layer of the overlay when it is illuminated from behind by the LED, which is soldered onto the instrument cluster electronic circuit board.

The service 4WD indicator is serviced as a unit with the instrument cluster.

OPERATION

SERVICE 4WD INDICATOR

The service 4WD indicator gives an indication to the vehicle operator when the Totally Integrated Power Module (TIPM) has recorded a Diagnostic Trouble Code (DTC) for an electronic transfer case circuit or component malfunction. This indicator is controlled by a transistor on the instrument cluster circuit board based upon cluster programming and electronic messages received by the cluster over the Controller Area Network (CAN) data bus.

The service 4WD indicator Light Emitting Diode (LED) is completely controlled by the instrument cluster logic circuit, and that logic will only allow this indicator to operate when the instrument cluster receives a battery current input on the fused ignition switch output (run-start) circuit. Therefore, the LED will always be OFF when the ignition switch is in any position except ON or START. The LED only illuminates when it is provided a path to ground by the instrument cluster transistor. The instrument cluster will turn ON the service 4WD indicator for the following reasons:

- **Bulb Test** - Each time the ignition switch is turned to the ON position the service 4WD indicator is illuminated for about two seconds as a bulb test.
- **Service 4WD Indicator Lamp-On Message** - Each time the cluster receives an electronic **service 4WD indicator lamp-ON** message from the TIPM, the service 4WD indicator will be illuminated. The indicator remains illuminated until the cluster receives a lamp-OFF message from the TIPM, or until the ignition switch is turned to the OFF position, whichever occurs first.
- **Communication Error** - If the cluster receives no lamp-ON or lamp-OFF messages from the TIPM for 10 seconds, the service 4WD indicator is illuminated by the cluster to indicate a loss of TIPM communication. The indicator remains controlled and illuminated by the cluster until a valid message is received from the TIPM.
- **Actuator Test** - Each time the cluster is put through the actuator test, the service 4WD indicator will be turned ON, then OFF again during the bulb check portion of the test to confirm the functionality of the LED and the cluster control circuitry.

The TIPM continually monitors the electronic transfer case control circuits and transfer case shift motor/mode sensor assembly to determine the condition of the system. The TIPM then sends the proper lamp-ON or lamp-OFF message to the Electro Mechanical Instrument Cluster (EMIC).

For proper diagnosis of the TIPM, the EMIC, the CAN data bus or the electronic communication related to service 4WD indicator operation a diagnostic scan tool is required. Refer to the appropriate diagnostic information.

SPEEDOMETER

DESCRIPTION

SPEEDOMETER

The image shows a stylized graphic of a speedometer dial. The text 'MPH km/h' is displayed in a large, bold, black, pixelated font. The 'MPH' and 'km/h' are positioned on either side of a central vertical line, with the 'h' in 'km/h' being slightly lower than the 'h' in 'MPH'.

Fig. 34: Speedometer

Courtesy of CHRYSLER LLC

A speedometer is standard equipment on all instrument clusters. The speedometer is located in the center of the instrument cluster, between the tachometer and the minor gauge set. The speedometer consists of a movable gauge needle or pointer controlled by the instrument cluster circuitry and a fixed 210 degree primary scale on the gauge dial face that reads left-to-right either from **0** to **120** or **140** mph, or from **0** to **240** km/h, depending upon the market for which the vehicle is manufactured.

Each version also has a secondary inner scale on the gauge dial face that provides the equivalent opposite units from the primary scale. Text appearing on the cluster overlay below the high end of the scales abbreviates the unit of measure for the primary scale (either **MPH** or **km/h**), and below the low end of the scales abbreviates the unit of measure for the secondary scale.

The speedometer graphics are white, gray and black against a black field, making them clearly visible within the instrument cluster in daylight. When illuminated from behind by the panel lamps dimmer controlled cluster illumination lighting with the exterior lamps turned ON, the graphics retain their unilluminated colors and appearance. The orange gauge needle has internal optical illumination. Gauge illumination is provided by Light Emitting Diode (LED) units soldered onto the instrument cluster electronic circuit board.

The speedometer is serviced as a unit with the instrument cluster.

OPERATION

SPEEDOMETER

2007 Dodge Nitro R/T

2007 ACCESSORIES AND EQUIPMENT Instrument Cluster - Service Information - Nitro

The speedometer gives an indication to the vehicle operator of the vehicle road speed. This gauge is controlled by the instrument cluster circuit board based upon cluster programming and electronic messages received by the cluster from the Powertrain Control Module (PCM) over the Controller Area Network (CAN) data bus.

The speedometer is driven by an electronic stepper motor unit that receives battery current on the instrument cluster electronic circuit board through the fused ignition switch output (run-start) circuit whenever the ignition switch is in the ON or START positions. The cluster is programmed to move the gauge needle back to the low end of the scale after the ignition switch is turned to the OFF position. The instrument cluster circuitry controls the gauge needle position and provides the following features:

- **Vehicle Speed Message** - Each time the cluster receives an electronic **vehicle speed** message from the PCM it will calculate the correct vehicle speed reading and position the gauge needle at that relative speed position on the gauge scale. The cluster will receive a new message and reposition the gauge pointer accordingly about every 88 milliseconds. The gauge needle will continually be positioned at the relative vehicle speed position on the gauge scale until the vehicle stops moving, or until the ignition switch is turned to the OFF position, whichever occurs first.
- **Communication Error** - If the cluster fails to receive a speed message, it will hold the gauge needle at the last indication for about three seconds, or until the ignition switch is turned to the OFF position, whichever occurs first. After three seconds, the gauge needle will return to the left end of the gauge scale.
- **Actuator Test** - Each time the cluster is put through the actuator test, the speedometer needle will be swept to several calibration points on the gauge scale in a prescribed sequence in order to confirm the functionality of the gauge and the cluster control circuitry.

The PCM continually monitors the Vehicle Speed Sensor (VSS) to determine the vehicle road speed. The PCM then sends the proper **vehicle speed** messages to the Electro Mechanical Instrument Cluster (EMIC) (also known as the Cab Compartment Node/CCN).

For proper diagnosis of the VSS, the PCM, the EMIC, the CAN data bus or the electronic communication related to speedometer operation a diagnostic scan tool is required. Refer to the appropriate diagnostic information.

TACHOMETER

DESCRIPTION

TACHOMETER

RPM X 1000

Fig. 35: Tachometer

Courtesy of CHRYSLER LLC

A tachometer is standard equipment on all instrument clusters. The tachometer is located to the right of the speedometer in the instrument cluster. The tachometer consists of a movable gauge needle or pointer controlled by the instrument cluster circuitry and a fixed 185 degree scale on the gauge dial face that reads left-to-right either from **0** to **7** for vehicles with a gasoline engine, or from **0** to **6** for vehicles with a diesel engine. The text **RPM X 1000** imprinted on the cluster overlay directly above the hub of the tachometer needle identifies that each number on the tachometer scale is to be multiplied by 1000 RPM.

The tachometer graphics are white, gray and black against a black field except for several red graduations that designate the red line area at the high end of the gauge scale, making them clearly visible within the instrument cluster in daylight. When illuminated from behind by the panel lamps dimmer controlled cluster illumination lighting with the exterior lamps turned ON, the graphics retain their unilluminated colors and appearance. The orange gauge needle has internal optical illumination. Gauge illumination is provided by Light Emitting Diode (LED) units soldered onto the instrument cluster electronic circuit board.

The tachometer is serviced as a unit with the instrument cluster.

OPERATION

TACHOMETER

The tachometer gives an indication to the vehicle operator of the engine speed. This gauge is controlled by the instrument cluster circuit board based upon cluster programming and electronic messages received by the cluster from the Powertrain Control Module (PCM) over the Controller Area Network (CAN) data bus.

The tachometer is driven by an electronic stepper motor unit that receives battery current on the instrument cluster electronic circuit board through the fused ignition switch output (run-start) circuit whenever the ignition switch is in the ON or START positions. The cluster is programmed to move the gauge needle back to the low end of the scale after the ignition switch is turned to the OFF position. The instrument cluster circuitry controls

the gauge needle position and provides the following features:

- **Engine Speed Message** - Each time the cluster receives an electronic **engine speed** message from the PCM it will calculate the correct engine speed reading and position the gauge needle at that relative speed position on the gauge scale. The cluster will receive a new message and reposition the gauge pointer accordingly about every 88 milliseconds. The gauge needle will continually be repositioned at the relative engine speed position on the gauge scale until the engine stops running, or until the ignition switch is turned to the OFF position, whichever occurs first.
- **Communication Error** - If the cluster fails to receive a speed message, it will hold the gauge needle at the last indication for about three seconds, or until the ignition switch is turned to the OFF position, whichever occurs first. After three seconds, the gauge needle will return to the left end of the gauge scale.
- **Actuator Test** - Each time the cluster is put through the actuator test, the tachometer needle will be swept to several calibration points on the gauge scale in a prescribed sequence in order to confirm the functionality of the gauge and the cluster control circuitry.

The PCM continually monitors the crankshaft position sensor to determine the engine speed. The PCM then sends the proper **engine speed** messages to the Electro Mechanical Instrument Cluster (EMIC) (also known as the Cab Compartment Node/CCN).

For proper diagnosis of the crankshaft position sensor, the PCM, the EMIC, the CAN data bus or the electronic communication related to tachometer operation a diagnostic scan tool is required. Refer to the appropriate diagnostic information.

TOW/HAUL INDICATOR

DESCRIPTION

TOW/HAUL INDICATOR

The image shows the text 'TOW/HAUL' in a bold, sans-serif font. The word 'TOW/' is on the top line and 'HAUL' is on the bottom line, both left-aligned.

Fig. 36: Identifying Tow/Haul Indicator
Courtesy of CHRYSLER LLC

A tow/haul indicator is standard equipment on all instrument clusters. However, on vehicles not equipped with an optional automatic transmission this indicator is electronically disabled. This indicator is located near the base of the speedometer needle hub on the cluster overlay, just right of center.

The tow/haul indicator consists of a stencil-like cutout of the text **TOW/HAUL** in the opaque layer of the instrument cluster overlay. The dark outer layer of the overlay prevents the indicator from being clearly visible when it is not illuminated. An amber Light Emitting Diode (LED) behind the cutout in the opaque layer of the overlay causes the indicator to appear in amber through the translucent outer layer of the overlay when it is illuminated from behind by the LED, which is soldered onto the instrument cluster electronic circuit board.

The tow/haul indicator is serviced as a unit with the instrument cluster.

OPERATION

TOW/HAUL INDICATOR

The tow/haul indicator gives an indication to the vehicle operator when the tow/haul function of the tow/haul switch has been selected, revising the shift schedule of the electronically controlled automatic transmission. This indicator is controlled by a transistor on the instrument cluster circuit board based upon cluster programming and electronic messages received by the cluster from the Powertrain Control Module (PCM) over the Controller Area Network (CAN) data bus.

The tow/haul indicator Light Emitting Diode (LED) is completely controlled by the instrument cluster logic circuit, and that logic will only allow this indicator to operate when the instrument cluster receives a battery current input on the fused ignition switch output (run-start) circuit. Therefore, the LED will always be OFF when the ignition switch is in any position except ON or START. The LED only illuminates when it is provided a path to ground by the instrument cluster transistor. The instrument cluster will turn ON the tow/haul indicator for the following reasons:

- **Tow/Haul Indicator Lamp-On Message** - Each time the cluster receives an electronic **tow/haul indicator lamp-ON** message from the PCM indicating that the tow/haul shift schedule has been selected, the indicator will be illuminated. The indicator remains illuminated until the cluster receives a lamp-OFF message from the PCM, or until the ignition switch is turned to the OFF position, whichever occurs first.
- **Actuator Test** - Each time the cluster is put through the actuator test, the tow/haul indicator will be turned ON, then OFF again during the bulb check portion of the test to confirm the functionality of the LED and the cluster control circuitry.

The PCM continually monitors the tow/haul switch to determine the proper outputs to the automatic transmission. The PCM then sends the proper lamp-ON or lamp-OFF message to the Electro Mechanical Instrument Cluster (EMIC) (also known as the Cab Compartment Node/CCN). For further diagnosis of the tow/haul indicator or the instrument cluster circuitry that controls the LED, see **DIAGNOSIS AND TESTING**.

For proper diagnosis of the transmission control system, the PCM, the EMIC, the CAN data bus or the electronic communication related to tow/haul indicator operation a diagnostic scan tool is required. Refer to the appropriate diagnostic information.

TIRE PRESSURE MONITOR INDICATOR

DESCRIPTION

TIRE PRESSURE MONITOR INDICATOR



Fig. 37: Tire Pressure Monitor Indicator
Courtesy of CHRYSLER LLC

A Tire Pressure Monitor (TPM) indicator is standard equipment on all instrument clusters. However, on vehicles not equipped with the TPM system, this indicator is electronically disabled. This indicator is located within the odometer Vacuum Fluorescent Display (VFD) unit.

The TPM indicator consists of a stencil-like cutout of an icon that represents a cross-section of a tire with a centered exclamation point in the VFD unit. The odometer VFD unit is soldered onto the instrument cluster electronic circuit board, and is visible through a window with a smoked clear lens located on the lower edge of the tachometer gauge dial face of the cluster overlay. The dark lens over the VFD prevents it from being clearly visible when it is not illuminated. The indicator appears in an amber color when it is illuminated by the cluster electronic circuit board, and the TPM indicator as well as all of the odometer VFD information is illuminated at full (daytime) brightness and cannot be dimmed until the TPM indicator is extinguished.

The TPM indicator is serviced as a unit with the odometer VFD unit in the instrument cluster.

OPERATION

TIRE PRESSURE MONITOR INDICATOR

The Tire Pressure Monitor (TPM) indicator gives an indication to the vehicle operator of the status of the TPM system. The TPM indicator is controlled by the instrument cluster circuit board based upon cluster programming and electronic messages received by the cluster from the Sentry Key REMote Entry Module (SKREEM) (also known as the Wireless Control Module/WCM) over the Controller Area Network (CAN) data bus.

The TPM indicator is completely controlled by the instrument cluster logic circuit, and that logic will only allow this indicator to operate when the instrument cluster receives a battery current input on the fused ignition switch output (run-start) circuit. Therefore, the indicator will always be OFF when the ignition switch is in any position except ON or START. The indicator only illuminates when it is energized by the instrument cluster

logic circuit. The instrument cluster will turn ON the TPM indicator for the following reasons:

- **Bulb Test** - Each time the ignition switch is turned to the ON position, the SKREEM sends an electronic **TPM indicator lamp-ON** message to the cluster to illuminate the TPM indicator for about three seconds as a bulb test.
- **TPM Indicator Lamp-On Message** - Each time the cluster receives an electronic **TPM indicator lamp-ON** message from the SKREEM, the indicator will be illuminated. The indicator can be flashed ON and OFF, or illuminated solid, as dictated by the SKREEM message. The indicator remains illuminated until the cluster receives a lamp-OFF message from the SKREEM, or until the ignition switch is turned to the OFF position, whichever occurs first.
- **Communication Error** - If the cluster receives no TPM lamp-ON or lamp-OFF messages from the SKREEM for six consecutive seconds, the TPM indicator is illuminated by the instrument cluster. The indicator remains controlled and illuminated by the cluster until a valid lamp-ON or lamp-OFF message is received from the SKREEM.
- **Actuator Test** - Each time the cluster is put through the actuator test, the TPM indicator will be turned ON, then OFF again during the odometer VFD portion of the test in order to confirm the functionality of the VFD and the cluster control circuitry.

The SKREEM performs a self-test each time the ignition switch is turned to the ON position to decide whether the TPM system is in good operating condition and whether the tire inflation pressures are too high or too low. The SKREEM then sends the proper lamp-ON or lamp-OFF message to the Electro Mechanical Instrument Cluster (EMIC) (also known as the Cab Compartment Node/CCN). If the instrument cluster turns ON the TPM indicator after the bulb test, it indicates that the inflation pressure of a tire is too low or that a malfunction has occurred and the TPM system is ineffective.

For proper diagnosis of the TPM system, the SKREEM, the EMIC, the CAN data bus or the electronic communication related to TPM indicator operation a diagnostic scan tool is required. Refer to the appropriate diagnostic information.

TRACTION CONTROL INDICATOR

DESCRIPTION

TRACTION CONTROL INDICATOR



Fig. 38: Traction Control Indicator**Courtesy of CHRYSLER LLC**

A traction control indicator is standard equipment on all instrument clusters. This indicator is located near the bottom of the speedometer dial face of the cluster overlay, directly below the speedometer needle hub.

The traction control indicator consists of a stencil-like cutout of the International Control and Display Symbol icon for **Stability - Anti-Spin** in the opaque layer of the instrument cluster overlay. The dark outer layer of the overlay prevents the indicator from being clearly visible when it is not illuminated. An amber Light Emitting Diode (LED) behind the cutout in the opaque layer of the overlay causes the indicator to appear in amber through the translucent outer layer of the overlay when it is illuminated from behind by the LED, which is soldered onto the instrument cluster electronic circuit board.

The traction control indicator is serviced as a unit with the instrument cluster.

OPERATION**TRACTION CONTROL INDICATOR**

The traction control indicator gives an indication to the vehicle operator when the Electronic Stability Program (ESP)/Brake Assist System (BAS)/Traction Control System (TCS) has been activated. This indicator is controlled by the instrument cluster logic circuit based upon cluster programming and electronic messages received by the cluster from the Controller Antilock Brake (CAB) over the Controller Area Network (CAN) data bus.

The traction control indicator is completely controlled by the instrument cluster logic circuit, and that logic will only allow this indicator to operate when the instrument cluster receives a battery current input on the fused ignition switch output (run-start) circuit. Therefore, the indicator will always be OFF when the ignition switch is in any position except ON or START. The indicator only illuminates when it is provided a path to ground by the instrument cluster circuitry. The instrument cluster will turn ON the traction control indicator for the following reasons:

- **Bulb Test** - Each time the ignition switch is turned to the ON position the traction control indicator is illuminated for about four seconds as a bulb test. The entire bulb test is a function of the CAB.
- **Traction Control Indicator Lamp-On Message** - Each time the cluster receives an electronic **traction control indicator lamp-ON** message from the CAB indicating that the ESP/BAS/TCS has been activated, the traction control indicator will be illuminated. The indicator can be flashed ON and OFF, or illuminated solid, as dictated by the CAB message. The indicator remains illuminated solid or continues to flash until the cluster receives a lamp-OFF message from the CAB, or until the ignition switch is turned to the OFF position, whichever occurs first.
- **Actuator Test** - Each time the cluster is put through the actuator test, the traction control indicator will be turned ON, then OFF again during the bulb check portion of the test to confirm the functionality of the LED and the cluster control circuitry.

The CAB continually monitors the traction control switch to determine the proper outputs to the components of the Antilock Brake System (ABS). The CAB then sends the proper lamp-ON or lamp-OFF message to the Electro Mechanical Instrument Cluster (EMIC) (also known as the Cab Compartment Node/CCN).

For proper diagnosis of the traction control switch, the ESP/BAS/TCS, the CAB, the EMIC, the CAN data bus or the electronic communication related to traction control indicator operation a diagnostic scan tool is required. Refer to the appropriate diagnostic information.

TRANS TEMP INDICATOR

DESCRIPTION

TRANSMISSION OVERTEMP INDICATOR



Fig. 39: Identifying Transmission Overtemp Indicator
Courtesy of CHRYSLER LLC

A transmission over-temperature indicator is standard equipment on all instrument clusters. However, on vehicles not equipped with an optional automatic transmission, this indicator is electronically disabled. This indicator is located near the bottom of the speedometer dial face of the cluster overlay, just right of center.

The transmission over-temperature indicator consists of a stencil-like cutout of the International Control and Display Symbol icon for **Transmission Temperature** in the opaque layer of the instrument cluster overlay. The dark outer layer of the overlay prevents the indicator from being clearly visible when it is not illuminated. A red Light Emitting Diode (LED) behind the cutout in the opaque layer of the overlay causes the indicator to appear in red through the translucent outer layer of the overlay when it is illuminated from behind by the LED, which is soldered onto the instrument cluster electronic circuit board.

The transmission over-temperature indicator is serviced as a unit with the instrument cluster.

OPERATION

TRANSMISSION OVERTEMP INDICATOR

The transmission over-temperature indicator gives an indication to the vehicle operator when the transmission fluid temperature is excessive, which may lead to accelerated transmission component wear or failure. This indicator is controlled by a transistor on the instrument cluster circuit board based upon cluster programming and electronic messages received by the cluster from the Powertrain Control Module (PCM) over the Controller Area Network (CAN) data bus.

2007 Dodge Nitro R/T

2007 ACCESSORIES AND EQUIPMENT Instrument Cluster - Service Information - Nitro

The transmission over-temperature indicator Light Emitting Diode (LED) is completely controlled by the instrument cluster logic circuit, and that logic will only allow this indicator to operate when the instrument cluster receives a battery current input on the fused ignition switch output (run-start) circuit. Therefore, the LED will always be OFF when the ignition switch is in any position except ON or START. The LED only illuminates when it is provided a path to ground by the instrument cluster transistor. The instrument cluster will turn ON the transmission over-temperature indicator for the following reasons:

- **Bulb Test** - Each time the ignition switch is turned to the ON position the transmission over-temperature indicator is illuminated for about two seconds as a bulb test.
- **Trans Over-Temp Indicator Lamp-On Message** - Each time the cluster receives an electronic **trans over-temp indicator lamp-ON** message from the PCM indicating that the transmission fluid temperature is 135°C (275°F) or higher, the indicator will be illuminated and a single chime tone is sounded. The indicator remains illuminated until the cluster receives a lamp-OFF message from the PCM, or until the ignition switch is turned to the OFF position, whichever occurs first. The chime tone feature will only repeat during the same ignition cycle if the indicator is cycled OFF and then ON again by the appropriate lamp-ON and lamp-OFF messages from the PCM.
- **Actuator Test** - Each time the cluster is put through the actuator test, the transmission over-temperature indicator will be turned ON, then OFF again during the bulb check portion of the test to confirm the functionality of the LED and the cluster control circuitry.

The PCM continually monitors the transmission temperature sensor to determine the transmission operating condition. The PCM then sends the proper lamp-ON or lamp-OFF message to the Electro Mechanical Instrument Cluster (EMIC) (also known as the Cab Compartment Node/CCN). If the instrument cluster illuminates the transmission over-temperature indicator due to a high transmission oil temperature condition, it may indicate that the transmission or the transmission cooling system are being overloaded, or that they require service. For further diagnosis of the transmission over-temperature indicator or the instrument cluster circuitry that controls the LED, see **DIAGNOSIS AND TESTING**.

For proper diagnosis of the transmission temperature sensor, the PCM, the EMIC, the CAN data bus or the electronic communication related to transmission over-temperature indicator operation a diagnostic scan tool is required. Refer to the appropriate diagnostic information.

TURN SIGNAL INDICATOR

DESCRIPTION

TURN SIGNAL INDICATOR

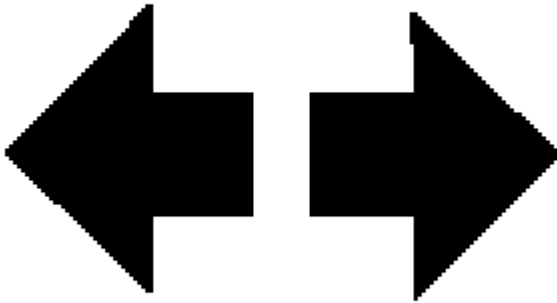

Fig. 40: Turn Signal Indicator
Courtesy of CHRYSLER LLC

Two turn signal indicators, one right and one left, are standard equipment on all instrument clusters. The turn signal indicators are located near the bottom of the speedometer dial face of the cluster overlay, one on the right and one on the left. Illumination of this indicator may also be accompanied by the display of a turn signal-on warning textual message in the cluster reconfigurable Vacuum Fluorescent Display (VFD) unit.

Each turn signal indicator consists of a stencil-like cutout of the International Control and Display Symbol icon for **Turn Warning** in the opaque layer of the instrument cluster overlay. The dark outer layer of the overlay prevents these icons from being clearly visible when they are not illuminated. A green Light Emitting Diode (LED) behind each cutout in the opaque layer of the overlay causes the indicator to appear in green through the translucent outer layer of the overlay when it is illuminated from behind by the LED, which is soldered onto the instrument cluster electronic circuit board.

The turn signal indicators are serviced as a unit with the instrument cluster.

OPERATION

TURN SIGNAL INDICATOR

The turn signal indicators give an indication to the vehicle operator that the turn signal (left or right indicator flashing) or hazard warning (both left and right indicators flashing) have been selected and are operating. These indicators are controlled by transistors on the instrument cluster electronic circuit board based upon the cluster programming and electronic messages received from the Totally Integrated Power Module (TIPM) over the Controller Area Network (CAN) data bus.

Each turn signal indicator Light Emitting Diode (LED) is completely controlled by the instrument cluster logic circuit, and that logic will allow this indicator to operate whenever the instrument cluster receives a battery current input on the fused B(+) circuit. Therefore, each LED can be illuminated regardless of the ignition switch position. The LED only illuminates when it is provided a path to ground by the instrument cluster transistor

The instrument cluster will turn ON the turn signal indicators for the following reasons:

- **Turn Signal Indicator Lamp-On Message** - Each time the cluster receives an electronic **right** or **left turn signal-ON** message from the TIPM over the CAN data bus, the appropriate turn signal indicator will be flashed ON and OFF. The TIPM also sends the appropriate electronic message to the cluster to control the flash rate of the turn signal indicators, as well as to control the click rate of an electromechanical relay soldered onto the cluster electronic circuit board that emulates the sound emitted by a conventional turn signal flasher. The turn signal indicators continue to flash ON and OFF until the cluster receives a lamp-OFF message from the TIPM, or until the ignition switch is turned to the OFF position, whichever occurs first.
- **Hazard Warning Indicator Lamp-On Message** - Each time the cluster receives an electronic **hazard warning-ON** message from the TIPM over the CAN data bus, both turn signal indicators will be flashed ON and OFF. The TIPM also sends the appropriate electronic messages to the cluster to control the flash rate of the right and left turn signal indicators, as well as to control the click rate of an electromechanical relay soldered onto the cluster electronic circuit board that emulates the sound emitted by a conventional hazard warning flasher. The turn signal indicators continue to flash ON and OFF until the cluster receives a hazard warning-OFF message from the TIPM.
- **Turn Signal-On Textual Warning Message** - When the cluster detects that a turn signal has been active continuously for 1.6 kilometers (1 mile) with the vehicle speed greater than 22 kilometers-per-hour (15 miles-per hour) a chime tone will be sounded and, if the vehicle is so equipped, a **TURN SIGNAL ON** textual message will appear within the instrument cluster reconfigurable Vacuum Fluorescent Display (VFD) unit.
- **Lamp Out Mode** - If the TIPM detects an ineffective turn signal lamp or circuit, it increases the flash rate for the remaining operative turn signals and sends an electronic message to the instrument cluster. To provide an indication of the problem to the vehicle operator the instrument cluster then increases the flash rate of the turn signal indicators, the click rate of the electromechanical relay and, if the vehicle is so equipped, displays a **TURN SIGNAL LAMP OUT** textual message in the reconfigurable VFD unit.
- **Actuator Test** - Each time the cluster is put through the actuator test, the turn signal indicators will be turned ON, then OFF again during the bulb check portion of the test to confirm the functionality of each LED and the cluster control circuitry.

The Electro Mechanical Instrument Cluster (EMIC) (also known as the Cab Compartment Node/CCN) continually monitors the electronic messages from the TIPM to determine the proper turn signal and hazard warning indicator operation.

For proper diagnosis of the turn signal and hazard warning system, the multi-function switch, the TIPM, the EMIC, the CAN data bus or the electronic communication related to turn signal indicator operation a diagnostic scan tool is required. Refer to the appropriate diagnostic information.

WAIT-TO-START INDICATOR

DESCRIPTION

WAIT-TO-START INDICATOR



Fig. 41: Wait-To-Start Indicator
Courtesy of CHRYSLER LLC

A wait-to-start indicator is standard equipment on all instrument clusters. However, on vehicles not equipped with an optional diesel engine, this indicator is electronically disabled. This indicator is located near the bottom of the speedometer dial face of the cluster overlay, just right of center.

The wait-to-start indicator consists of a stencil-like cutout of the International Control and Display Symbol icon for **Diesel Preheat** in the opaque layer of the instrument cluster overlay. The dark outer layer of the overlay prevents the indicator from being clearly visible when it is not illuminated. An amber Light Emitting Diode (LED) behind the cutout in the opaque layer of the overlay causes the indicator to appear in amber through the translucent outer layer of the overlay when it is illuminated from behind by the LED, which is soldered onto the instrument cluster electronic circuit board.

The wait-to-start indicator is serviced as a unit with the instrument cluster.

OPERATION

WAIT-TO-START INDICATOR

The wait-to-start indicator gives an indication to the vehicle operator when the diesel engine is too cool for efficient and reliable engine starting, and the engine glow plugs are energized in their pre-heat operating mode. This indicator is controlled by a transistor on the instrument cluster circuit board based upon cluster programming and electronic messages received by the cluster from the Powertrain Control Module (PCM) over the Controller Area Network (CAN) data bus.

The wait-to-start indicator Light Emitting Diode (LED) is completely controlled by the instrument cluster logic circuit, and that logic will only allow this indicator to operate when the instrument cluster receives a battery current input on the fused ignition switch output (run-start) circuit. Therefore, the LED will always be OFF when the ignition switch is in any position except ON or START. The LED only illuminates when it is provided a path to ground by the instrument cluster transistor. The instrument cluster will turn ON the wait-to-start indicator for the following reasons:

- **Wait-To-Start Indicator Lamp-On Message** - Each time the cluster receives an electronic **wait-to-start indicator lamp-ON** message from the PCM indicating that the air temperature is too cool for efficient and reliable engine starting and the glow plugs are energized in their pre-heat mode, the wait-to-start indicator will be illuminated. The indicator remains illuminated until the cluster receives a lamp-OFF

message from the PCM, until the PCM detects that the engine is running, or until the ignition switch is turned to the OFF position, whichever occurs first.

- **Actuator Test** - Each time the cluster is put through the actuator test, the wait-to-start indicator will be turned ON, then OFF again during the bulb check portion of the test to confirm the functionality of the LED and the cluster control circuitry.

The PCM continually monitors the glow plug control circuits to determine when they are energized in their pre-heat operating mode. The PCM then sends the proper lamp-ON or lamp-OFF message to the Electro Mechanical Instrument Cluster (EMIC) (also known as the Cab Compartment Node/CCN).

For proper diagnosis of the glow plug control circuits, the PCM, the EMIC, the CAN data bus or the electronic communication related to wait-to-start indicator operation a diagnostic scan tool is required. Refer to the appropriate diagnostic information.

WATER-IN-FUEL INDICATOR

DESCRIPTION

WATER-IN-FUEL INDICATOR



Fig. 42: Identifying Water-In-Fuel Indicator
Courtesy of CHRYSLER LLC

A water-in-fuel indicator is standard equipment on all instrument clusters. However, on vehicles not equipped with an optional diesel engine, this indicator is electronically disabled. This indicator is located near the bottom of the speedometer dial face of the cluster overlay, just left of center.

The water-in-fuel indicator consists of a stencil-like cutout of the International Control and Display Symbol icon for **Water In Fuel** in the opaque layer of the instrument cluster overlay. The dark outer layer of the overlay prevents the indicator from being clearly visible when it is not illuminated. An amber Light Emitting Diode (LED) behind the cutout in the opaque layer of the overlay causes the indicator to appear in amber through the translucent outer layer of the overlay when it is illuminated from behind by the LED, which is soldered onto the instrument cluster electronic circuit board.

The water-in-fuel indicator is serviced as a unit with the instrument cluster.

OPERATION

WATER-IN-FUEL INDICATOR

The water-in-fuel indicator gives an indication to the vehicle operator when there is excessive water detected in the diesel fuel. This indicator is controlled by the instrument cluster circuit board based upon cluster programming and electronic messages received over the Controller Area Network (CAN) data bus from the Powertrain Control Module (PCM).

The water-in-fuel indicator Light Emitting Diode (LED) is completely controlled by the instrument cluster logic circuit, and that logic will only allow this indicator to operate when the instrument cluster receives a battery current input on the fused ignition switch output (run-start) circuit. Therefore, the LED will always be OFF when the ignition switch is in any position except ON or START. The LED only illuminates when it is provided a path to ground by the instrument cluster transistor. The instrument cluster will turn ON the water-in-fuel indicator for the following reasons:

- **Water-In-Fuel Indicator Lamp-On Message** - Each time the cluster receives an electronic **water-in-fuel indicator lamp-ON** message from the PCM indicating there is excessive water in the diesel fuel system, the water-in-fuel indicator will be illuminated. The indicator remains illuminated until the cluster receives a lamp-OFF message from the PCM, or until the ignition switch is turned to the OFF position, whichever occurs first.

The PCM continually monitors the water-in-fuel sensor to determine whether there is excessive water in the diesel fuel system. The PCM then sends the proper electronic **water-in-fuel** message to the Electro Mechanical Instrument Cluster (EMIC) (also known as the Cab Compartment Node/CCN).

For proper diagnosis of the water-in-fuel-sensor, the PCM, the EMIC, the CAN data bus or the electronic communication related to water-in-fuel indicator operation a diagnostic scan tool is required. Refer to the appropriate diagnostic information.