

## 2007 Dodge Nitro R/T

2007 HVAC Heating & Air Conditioning - Electrical Diagnostics - Nitro

### 2007 HVAC

#### Heating & Air Conditioning - Electrical Diagnostics - Nitro

## DIAGNOSTIC CODE INDEX

### DIAGNOSTIC CODE INDEX

DTC	Description
<u>B1006</u>	BI-LEVEL SWITCH REQUEST INPUT CIRCUIT PERFORMANCE
<u>B1000</u>	A/C SWITCH REQUEST INPUT CIRCUIT/PERFORMANCE
<u>B1003</u>	A/C PANEL MODE SWITCH REQUEST INPUT CIRCUIT/PERFORMANCE
<u>B1009</u>	RECIRCULATION SWITCH REQUEST INPUT CIRCUIT/PERFORMANCE
<u>B100C</u>	FLOOR MODE SWITCH REQUEST INPUT CIRCUIT PER
<u>B100F</u>	MIX SWITCH REQUEST INPUT CIRCUIT PER
<u>B1012</u>	DEFROST SWITCH REQUEST INPUT CIRCUIT/PERFORMANCE
<u>B1015</u>	REAR DEFROST SWITCH REQUEST INPUT CIRCUIT/PERFORMANCE
<u>B1031</u>	EVAPORATOR FIN TEMPERATURE SENSOR CIRCUIT LOW
<u>B1032</u>	EVAPORATOR FIN TEMPERATURE SENSOR CIRCUIT HIGH
<u>B1034</u>	INFRARED TEMPERATURE SENSOR INPUT CIRCUIT LOW
<u>B1034</u>	INFRARED TEMPERATURE SENSOR THERMISTOR CIRCUIT LOW
<u>B1035</u>	INFRARED TEMPERATURE SENSOR INPUT CIRCUIT HIGH
<u>B1040</u>	PANEL MODE DOOR 1 CONTROL CIRCUIT/PERFORMANCE
<u>B1043</u>	PANEL MODE DOOR 1 CONTROL CIRCUIT OPEN
<u>B1044</u>	PANEL MODE DOOR 1 TRAVEL RANGE TOO SMALL
<u>B1045</u>	PANEL MODE DOOR 1 TRAVEL RANGE TOO LARGE
<u>B1058</u>	RECIRCULATION DOOR CONTROL CIRCUIT/PERFORMANCE
<u>B105B</u>	RECIRCULATION DOOR CONTROL CIRCUIT OPEN (TIPM)
<u>B105B</u>	RECIRCULATION DOOR CONTROL CIRCUIT OPEN
<u>B105C</u>	RECIRCULATION DOOR TRAVEL RANGE TOO SMALL
<u>B105D</u>	RECIRCULATION DOOR TRAVEL RANGE TOO LARGE
<u>B10A2</u>	LEFT BLEND DOOR CONTROL CIRCUIT/PERFORMANCE
<u>B10A5</u>	LEFT BLEND DOOR CONTROL CIRCUIT OPEN
<u>B10B1</u>	INFRARED SENSOR THERMISTOR CIRCUIT HIGH
<u>B10B4</u>	CABIN HEATER 1 CONTROL CIRCUIT LOW (TIPM)
<u>B10B8</u>	CABIN HEATER 2 CONTROL CIRCUIT LOW (TIPM)
<u>B10B9</u>	CABIN HEATER 2 CONTROL CIRCUIT HIGH (TIPM)
<u>B10EA</u>	BLOWER MOTOR CONTROL CIRCUIT HIGH
<u>B10EC</u>	BLOWER MOTOR CONTROL CIRCUIT OVERCURRENT (TIPM)
<u>B1138</u>	CABIN HEATER 3 CONTROL CIRCUIT LOW (TIPM)
<u>B1139</u>	CABIN HEATER 3 CONTROL CIRCUIT HIGH (TIPM)
<u>B1610</u>	AMBIENT LIGHT SENSOR INPUT CIRCUIT LOW

## 2007 Dodge Nitro R/T

2007 HVAC Heating & Air Conditioning - Electrical Diagnostics - Nitro

<b><u>B1610</u></b>	AMBIENT LIGHT SENSOR INPUT CIRCUIT PERFORMANCE
<b><u>B1611</u></b>	AMBIENT LIGHT SENSOR INPUT CIRCUIT HIGH
<b><u>B210A</u></b>	SYSTEM VOLTAGE LOW
<b><u>B210B</u></b>	SYSTEM VOLTAGE HIGH
<b><u>B2214</u></b>	(HVAC) CLIMATE CONTROL INTERNAL
<b><u>B222A</u></b>	VEHICLE LINE MISMATCH
<b><u>U0010</u></b>	CAN INTERIOR BUS
<b><u>U0141</u></b>	LOST COMM W/INTEGRATED POWER MODULE/FRONT CONTROL MODULE/TIPM
<b><u>U0151</u></b>	LOST COMMUNICATION WITH OCCUPANT RESTRAINT CONTROLLER (ORC)
<b><u>U0154</u></b>	LOST COMMUNICATION WITH OCCUPANT CLASSIFICATION MODULE
<b><u>U0155</u></b>	LOST COMMUNICATION WITH CLUSTER/CCN
<b><u>U0159</u></b>	LOST COMMUNICATION WITH PARKING ASSIST CONTROL MODULE
<b><u>U0167</u></b>	LOST COMMUNICATION WITH INTRUSION TRANSCEIVER CONTROL MODULE
<b><u>U0168</u></b>	LOST COM WITH VEHICLE SECURITY CONTROL MODULE (SKREEM/WCM)
<b><u>U0169</u></b>	LOST COMMUNICATION WITH SUNROOF CONTROL MODULE
<b><u>U0181</u></b>	LOST COMMUNICATION WITH HEADLAMP LEVELING TRANSLATOR
<b><u>U0184</u></b>	LOST COMMUNICATION WITH RADIO
<b><u>U0186</u></b>	LOST COMMUNICATION WITH AUDIO AMPLIFIER
<b><u>U0187</u></b>	LOST COMMUNICATION WITH DVD PLAYER
<b><u>U0196</u></b>	LOST COMMUNICATION WITH VEHICLE ENTERTAINMENT CONTROL MODULE
<b><u>U0197</u></b>	LOST COMMUNICATION WITH HANDS FREE PHONE MODULE
<b><u>U0200</u></b>	LOST COMMUNICATION WITH PASSENGER DOOR MODULE
<b><u>U0201</u></b>	LOST COMMUNICATION WITH LEFT REAR DOOR MODULE
<b><u>U0202</u></b>	LOST COMMUNICATION WITH RIGHT REAR DOOR MODULE
<b><u>U0203</u></b>	LOST COMMUNICATION WITH DOOR MODULE FRONT LEFT
<b><u>U0203</u></b>	LOST COMMUNICATION WITH DOOR MODULE FRONT RIGHT
<b><u>U0209</u></b>	LOST COMMUNICATION WITH MEMORY SEAT CONTROL MODULE

## HVAC - ELECTRICAL DIAGNOSTICS

### DIAGNOSIS AND TESTING

### HEATING AND AIR CONDITIONING SYSTEM

### ON-BOARD DIAGNOSTICS

**CAUTION: Do not exchange A/C Heater Controls from vehicle to vehicle. Software**

**versions differ between models and model years. Installing an A/C Heater Control with software that is incompatible for a given vehicle can result in either improper or failed HVAC system operation.**

**NOTE: Always inspect the IOD fuse prior to diagnosing any heating-A/C system concerns. Make sure the fuse is functional and fully seated into the terminals of the totally integrated power module (TIPM) located in the engine compartment.**

The A/C-heater control communicates on the controller area network (CAN) IHS bus and is fully addressable with a scan tool.

The A/C-heater control's primary means of fault detection is through active and stored diagnostic trouble codes (DTCs). Active DTCs are those which currently exist in the system. The condition causing the fault must be repaired in order to clear this type of DTC. Stored DTCs are those which occurred in the system since the A/C-heater control received the last clear diagnostic info message. All DTCs must be read with a scan tool .

The A/C-heater control's secondary means of fault detection is through system tests. These tests include the HVAC System Test, the A/C Cooldown Test, the Actuator Calibration Function, and for MTC Systems, the Actuator DTC Detection Test. Refer to **SYSTEM TESTS** for a detailed description of each test.

## **SYSTEM TESTS**

### **HVAC System Test**

The HVAC System Test , provides a starting point in the diagnostic process by identifying the appropriate system test to perform when diagnosing a given condition or DTC. It also provides a means for testing the entire HVAC system by utilizing the A/C-heater control's On-Board System Tests. The On-Board System Tests can also assist in diagnosing stored DTCs.

### **A/C Cooldown Test**

The A/C Cooldown Test:

Is actuated with a scan tool.

Tests A/C system performance based on evaporator temperature sensor input.

Will fail if evaporator starting temperature is below 18°C (65°F) when initiating the test.

Will pass if the evaporator temperature drops 11°C (20°F).

Indicates test outcome by displaying one or more test status messages on the scan tool. These messages will clear after paging back out of this test function. Therefore, is it important to note all of the messages before doing so.

Will cause the A/C status indicator to flash while the test is running.

### **Actuator Calibration Function**

The Actuator Calibration function:

## 2007 Dodge Nitro R/T

2007 HVAC Heating & Air Conditioning - Electrical Diagnostics - Nitro

Is actuated with a scan tool.

Homes and repositions door actuators.

Monitors for door span faults. Door span faults (XXX Door Travel Range Too Large or XXX Door Travel Range Too Small) will only display after calibration.

Will cause the electric backlight (EBL) status indicator to flash while the test is running.

### Actuator DTC Detection Test

The Actuator DTC Detection Test:

Is actuated with a scan tool.

Supplements the continuous diagnostics on the actuator drive system.

Monitors for shorted actuator circuits allowing service to easily diagnose and troubleshoot up to three simultaneous shorts. Shorted actuator circuit faults (XXX Control Circuit High or XXX Control Circuit Low) will only display after running the Actuator DTC Detection Test.

After repairing each DTC, cycle the ignition switch, and then rerun the Actuator DTC Detection test to ensure that no new DTCs exist. If multiple DTCs are present, beginning with the common circuits, diagnose and repair all short high faults and then short low faults. When the test returns passed, proceed with troubleshooting by clearing faults and running the Actuator Calibration function as a final check of proper system operation.

### B1006-BI-LEVEL SWITCH REQUEST INPUT CIRCUIT PERFORMANCE

For complete wiring diagrams refer to [SYSTEM WIRING DIAGRAMS](#) article.

#### Theory of Operation

The Bi-Level mode switch input changes when the switch is pushed down. An active DTC indicates that the switch is stuck in a pushed position. A stored DTC indicates that the switch was stuck in a pushed position for more than two minutes, but has since returned to its normal state.

#### When Monitored:

With the ignition on.

#### Set Condition:

If the Bi-Level mode switch is stuck in a pushed position for more than two minutes. This DTC has a maturing time of two minutes and a de-maturing time of two seconds. If the DTC's status changes from active to stored it will stay in memory for 100 ignition cycles.

#### Possible Causes

OBJECT HOLDING SWITCH IN A PUSHED POSITION  
A/C HEATER CONTROL

**Diagnostic Test****1) VERIFY THE DTC IS STILL ACTIVE**

Inspect the A/C Heater Control for an object holding the switch in a pushed position. If present, remove the object.

Turn the ignition on.

With the scan tool, erase HVAC DTCs.

Turn the ignition off, wait 10 seconds, and then turn the ignition on. Wait 2 minutes before proceeding.

With the scan tool, read HVAC DTCs.

**Does the scan tool display this DTC?****Yes**

Replace the A/C Heater Control in accordance with the service information.

Perform **BODY VERIFICATION TEST - VER 1** .

**No**

The condition that caused this symptom is currently not present. Check for an intermittent condition by inspecting the related wiring harness for chafed, pierced, pinched, and partially broken wires. Also, inspect the related connectors for broken, bent, pushed out, spread, corroded, or contaminated terminals. Repair as necessary.

Perform **BODY VERIFICATION TEST - VER 1** .

**B1000-A/C SWITCH REQUEST INPUT CIRCUIT/PERFORMANCE**

For complete wiring diagrams refer to **SYSTEM WIRING DIAGRAMS** article.

The switch input changes when the switch is pushed down. A stored DTC indicates that the A/C request switch was stuck in a pushed position for more than 10 minutes, but has since returned to its normal state. An active DTC indicates that the A/C request switch is stuck in a pushed position. When active, this DTC will prevent proper A/C request switch and status indicator function.

**When Monitored:**

With the ignition on.

**Set Condition:**

If the A/C request switch is detected in a pushed position for more than 10 minutes.

## 2007 Dodge Nitro R/T

2007 HVAC Heating & Air Conditioning - Electrical Diagnostics - Nitro

### Possible Causes

OBJECT HOLDING A/C MODE SWITCH IN A PUSHED POSITION  
SUBSTANCE CAUSING A/C MODE SWITCH TO GET STUCK IN A PUSHED POSITION  
A/C HEATER CONTROL

#### Diagnostic Test

#### 1) VERIFY THE DTC IS STILL ACTIVE

Turn the ignition on.

With the scan tool, erase HVAC DTCs.

Turn the ignition off, wait 10 seconds, and then turn the ignition on. Wait 10 minutes before proceeding.

With the scan tool, read HVAC DTCs.

**Does the scan tool display this DTC?**

**Yes**

Go to 2).

**No**

The condition that caused this symptom is currently not present. Check for an intermittent condition by inspecting the related wiring harness for chafed, pierced, pinched, and partially broken wires. Also, inspect the related connectors for broken, bent, pushed out, spread, corroded, or contaminated terminals. Repair as necessary.

Perform **BODY VERIFICATION TEST - VER 1** .

#### 2) CHECK FOR NORMAL A/C REQUEST SWITCH & STATUS INDICATOR FUNCTION

Set the Blower control to any position except Off.

Set the Mode control to any position except Auto.

Press the A/C request switch on and off several times while observing the A/C status indicator.

**Does the A/C status indicator turn on and off?**

**Yes**

Go to 4).

**No**

Go to 3).

**3) INSPECT FOR OBJECT OR SUBSTANCE CAUSING THE A/C REQUEST SWITCH TO STAY OR STICK IN A PUSHED POSITION**

Inspect the A/C Heater Control for anything that would cause the A/C request switch to stay or stick in a pushed position.

**Is anything present that would cause the A/C request switch to stay or stick in a pushed position?**

**Yes**

Repair as necessary.

Perform **BODY VERIFICATION TEST - VER 1** .

**No**

Go to 4).

**4) INSPECT THE A/C HEATER CONTROL FOR DAMAGE**

Inspect the A/C Heater Control for damage.

**Is the A/C Heater Control damaged?**

**Yes**

Replace the A/C Heater Control in accordance with the service information.

Perform **BODY VERIFICATION TEST - VER 1** .

**No**

Perform **BODY VERIFICATION TEST - VER 1** .

**B1003-A/C PANEL MODE SWITCH REQUEST INPUT CIRCUIT/PERFORMANCE**

For complete wiring diagrams refer to **SYSTEM WIRING DIAGRAMS** article.

The switch input changes when the switch is pushed down. A stored DTC indicates that the panel mode switch was stuck in a pushed position for more than 10 minutes, but has since returned to its normal state. An active DTC indicates that the panel mode switch is stuck in a pushed position. An active DTC will prevent proper A/C mode switch and status indicator function.

**When Monitored:**

With the ignition on.

## 2007 Dodge Nitro R/T

2007 HVAC Heating & Air Conditioning - Electrical Diagnostics - Nitro

### Set Condition:

If the panel mode switch is detected in a pushed position for more than 10 minutes.

### Possible Causes

OBJECT HOLDING PANEL MODE SWITCH IN A PUSHED POSITION  
SUBSTANCE CAUSING PANEL MODE SWITCH TO GET STUCK IN A PUSHED POSITION  
A/C HEATER CONTROL

### Diagnostic Test

#### 1) VERIFY THE DTC IS STILL ACTIVE

Turn the ignition on.

With the scan tool, erase HVAC DTCs.

Turn the ignition off, wait 10 seconds, and then turn the ignition on. Wait 10 minutes before proceeding.

With the scan tool, read HVAC DTCs.

#### Does the scan tool display this DTC?

**Yes**

Go to 2).

**No**

The condition that caused this symptom is currently not present. Check for an intermittent condition by inspecting the related wiring harness for chafed, pierced, pinched, and partially broken wires. Also, inspect the related connectors for broken, bent, pushed out, spread, corroded, or contaminated terminals. Repair as necessary.

Perform **BODY VERIFICATION TEST - VER 1** .

#### 2) CHECK FOR NORMAL PANEL MODE SWITCH & STATUS INDICATOR FUNCTION

Set the Blower control to any position except Off.

Set the Mode control to any position except Auto.

Press the Panel mode switch on and off several times while observing the Panel mode status indicator.

#### Does the Panel mode status indicator turn on and off?

**Yes**



Go to 4).

**No**

Go to 3).

**3) INSPECT FOR OBJECT OR SUBSTANCE CAUSING THE PANEL MODE SWITCH TO STAY OR STICK IN A PUSHED POSITION**

Inspect the A/C Heater Control for anything that would cause the Panel mode switch to stay or stick in a pushed position.

**Is anything present that would cause the Panel mode switch to stay or stick in a pushed position?**

**Yes**

Repair as necessary.

Perform **BODY VERIFICATION TEST - VER 1** .

**No**

Go to 4).

**4) INSPECT THE A/C HEATER CONTROL FOR DAMAGE**

Inspect the A/C Heater Control for damage.

**Is the A/C Heater Control damaged?**

**Yes**

Replace the A/C Heater Control in accordance with the service information.

Perform **BODY VERIFICATION TEST - VER 1** .

**No**

Perform **BODY VERIFICATION TEST - VER 1** .

**B1009-RECIRCULATION SWITCH REQUEST INPUT CIRCUIT/PERFORMANCE**

For complete wiring diagrams refer to **SYSTEM WIRING DIAGRAMS** article.

The switch input changes when the switch is pushed down. A stored DTC indicates that the recirculation switch was stuck in a pushed position for more than 10 minutes, but has since returned to its normal state. An active DTC indicates that the recirculation switch is stuck in a pushed position.

**When Monitored:**

## 2007 Dodge Nitro R/T

2007 HVAC Heating & Air Conditioning - Electrical Diagnostics - Nitro

With the ignition on.

### Set Condition:

If the recirculation switch is detected in a pushed position for more than 10 minutes.

### Possible Causes

OBJECT HOLDING RECIRCULATION SWITCH IN A PUSHED POSITION  
SUBSTANCE CAUSING RECIRCULATION SWITCH TO GET STUCK IN A PUSHED POSITION  
A/C HEATER CONTROL

### Diagnostic Test

#### 1) VERIFY THE DTC IS STILL ACTIVE

Turn the ignition on.

With the scan tool, erase HVAC DTCs.

Turn the ignition off, wait 10 seconds, and then turn the ignition on. Wait 10 minutes before proceeding.

With the scan tool, read HVAC DTCs.

#### Does the scan tool display this DTC?

**Yes**

Go to 2).

**No**

The condition that caused this symptom is currently not present. Check for an intermittent condition by inspecting the related wiring harness for chafed, pierced, pinched, and partially broken wires. Also, inspect the related connectors for broken, bent, pushed out, spread, corroded, or contaminated terminals. Repair as necessary.

Perform **BODY VERIFICATION TEST - VER 1** .

#### 2) CHECK FOR NORMAL RECIRCULATION SWITCH & STATUS INDICATOR FUNCTION

Set the Blower control to any position except Off.

Set the Mode control to any position except Auto.

Press the Recirculation switch on and off several times while observing the Recirculation status indicator.

#### Does the Recirculation status indicator turn on and off?

## 2007 Dodge Nitro R/T

2007 HVAC Heating & Air Conditioning - Electrical Diagnostics - Nitro

**Yes**

Go to 4).

**No**

Go to 3).

### **3) INSPECT FOR OBJECT OR SUBSTANCE CAUSING THE RECIRCULATION SWITCH TO STAY OR STICK IN A PUSHED POSITION**

Inspect the A/C Heater Control for anything that would cause the Recirculation switch to stay or stick in a pushed position.

**Is anything present that would cause the Recirculation switch to stay or stick in a pushed position?**

**Yes**

Repair as necessary.

Perform **BODY VERIFICATION TEST - VER 1** .

**No**

Go to 4).

### **4) INSPECT THE A/C HEATER CONTROL FOR DAMAGE**

Inspect the A/C Heater Control for damage.

**Is the A/C Heater Control damaged?**

**Yes**

Replace the A/C Heater Control in accordance with the service information.

Perform **BODY VERIFICATION TEST - VER 1** .

**No**

Perform **BODY VERIFICATION TEST - VER 1** .

### **B100C-FLOOR MODE SWITCH REQUEST INPUT CIRCUIT PER**

For complete wiring diagrams refer to **SYSTEM WIRING DIAGRAMS** article.

The Floor mode switch input changes when the switch is pushed down. An active DTC indicates that the switch is stuck in a pushed position. A stored DTC indicates that the switch was stuck in a pushed position for more than two minutes, but has since returned to its normal state.

## 2007 Dodge Nitro R/T

2007 HVAC Heating & Air Conditioning - Electrical Diagnostics - Nitro

### When Monitored:

With the ignition on.

### Set Condition:

If the Floor mode switch is stuck in a pushed position for more than two minutes. This DTC has a maturing time of two minutes and a de-maturing time of two seconds. If the DTC's status changes from active to stored it will stay in memory for 100 ignition cycles.

### Possible Causes

OBJECT HOLDING SWITCH IN A PUSHED POSITION  
A/C HEATER CONTROL

### Diagnostic Test

#### 1) VERIFY THE DTC IS STILL ACTIVE

Inspect the A/C Heater Control for an object holding the switch in a pushed position. If present, remove the object.

Turn the ignition on.

With the scan tool, erase HVAC DTCs.

Turn the ignition off, wait 10 seconds, and then turn the ignition on. Wait 2 minutes before proceeding.

With the scan tool, read HVAC DTCs.

#### Does the scan tool display this DTC?

**Yes**

Replace the A/C Heater Control in accordance with the service information.

Perform **BODY VERIFICATION TEST - VER 1** .

**No**

The condition that caused this symptom is currently not present. Check for an intermittent condition by inspecting the related wiring harness for chafed, pierced, pinched, and partially broken wires. Also, inspect the related connectors for broken, bent, pushed out, spread, corroded, or contaminated terminals. Repair as necessary.

Perform **BODY VERIFICATION TEST - VER 1** .

**B100F-MIX SWITCH REQUEST INPUT CIRCUIT PER**

## 2007 Dodge Nitro R/T

2007 HVAC Heating & Air Conditioning - Electrical Diagnostics - Nitro

For complete wiring diagrams refer to **SYSTEM WIRING DIAGRAMS** article.

The mix switch input changes when the switch is pushed down. An active DTC indicates that the switch is stuck in a pushed position. A stored DTC indicates that the switch was stuck in a pushed position for more than two minutes, but has since returned to its normal state.

### **When Monitored:**

With the ignition on.

### **Set Condition:**

If the mix switch is stuck in a pushed position for more than two minutes. This DTC has a maturing time of two minutes and a de-maturing time of two seconds. If the DTC's status changes from active to stored it will stay in memory for 100 ignition cycles.

### **Possible Causes**

OBJECT HOLDING SWITCH IN A PUSHED POSITION  
A/C HEATER CONTROL

### **Diagnostic Test**

#### **1) VERIFY THE DTC IS STILL ACTIVE**

Inspect the A/C Heater Control for an object holding the switch in a pushed position. If present, remove the object.

Turn the ignition on.

With the scan tool, erase HVAC DTCs.

Turn the ignition off, wait 10 seconds, and then turn the ignition on. Wait 2 minutes before proceeding.

With the scan tool, read HVAC DTCs.

#### **Does the scan tool display this DTC?**

**Yes**

Replace the A/C Heater Control in accordance with the service information.

Perform **BODY VERIFICATION TEST - VER 1** .

**No**

The condition that caused this symptom is currently not present. Check for an intermittent condition by inspecting the related wiring harness for chafed, pierced, pinched, and partially broken

## 2007 Dodge Nitro R/T

2007 HVAC Heating & Air Conditioning - Electrical Diagnostics - Nitro

wires. Also, inspect the related connectors for broken, bent, pushed out, spread, corroded, or contaminated terminals. Repair as necessary.

Perform **BODY VERIFICATION TEST - VER 1** .

### **B1012-DEFROST SWITCH REQUEST INPUT CIRCUIT/PERFORMANCE**

For complete wiring diagrams refer to **SYSTEM WIRING DIAGRAMS** article.

The switch input changes when the switch is pushed down. A stored DTC indicates that the defrost switch was stuck in a pushed position for more than 10 minutes, but has since returned to its normal state. An active DTC indicates that the defrost switch is stuck in a pushed position.

#### **When Monitored:**

With the ignition on.

#### **Set Condition:**

If the defrost switch is detected in a pushed position for more than 10 minutes.

#### **Possible Causes**

OBJECT HOLDING DEFROST SWITCH IN A PUSHED POSITION  
SUBSTANCE CAUSING DEFROST SWITCH TO GET STUCK IN A PUSHED POSITION  
A/C HEATER CONTROL

#### **Diagnostic Test**

##### **1) VERIFY THE DTC IS STILL ACTIVE**

Turn the ignition on.

With the scan tool, erase HVAC DTCs.

Turn the ignition off, wait 10 seconds, and then turn the ignition on. Wait 10 minutes before proceeding.

With the scan tool, read HVAC DTCs.

##### **Does the scan tool display this DTC?**

**Yes**

Go to 2).

**No**

The condition that caused this symptom is currently not present. Check for an intermittent

condition by inspecting the related wiring harness for chafed, pierced, pinched, and partially broken wires. Also, inspect the related connectors for broken, bent, pushed out, spread, corroded, or contaminated terminals. Repair as necessary.

Perform **BODY VERIFICATION TEST - VER 1** .

**2) CHECK FOR NORMAL DEFROST SWITCH & STATUS INDICATOR FUNCTION**

Set the Blower control to any position except Off.

Set the Mode control to any position except Auto.

Press the Defrost switch on and off several times while observing the Defrost status indicator.

**Does the Defrost status indicator turn on and off?**

**Yes**

Go to 4).

**No**

Go to 3).

**3) INSPECT FOR OBJECT OR SUBSTANCE CAUSING THE DEFROST SWITCH TO STAY OR STICK IN A PUSHED POSITION**

Inspect the A/C Heater Control for anything that would cause the Defrost switch to stay or stick in a pushed position.

**Is anything present that would cause the Defrost switch to stay or stick in a pushed position?**

**Yes**

Repair as necessary.

Perform **BODY VERIFICATION TEST - VER 1** .

**No**

Go to 4).

**4) INSPECT THE A/C HEATER CONTROL FOR DAMAGE**

Inspect the A/C Heater Control for damage.

**Is the A/C Heater Control damaged?**

**Yes**

## 2007 Dodge Nitro R/T

2007 HVAC Heating & Air Conditioning - Electrical Diagnostics - Nitro

Replace the A/C Heater Control in accordance with the service information.

Perform **BODY VERIFICATION TEST - VER 1** .

**No**

Perform **BODY VERIFICATION TEST - VER 1** .

### **B1015-REAR DEFROST SWITCH REQUEST INPUT CIRCUIT/PERFORMANCE**

For complete wiring diagrams refer to **SYSTEM WIRING DIAGRAMS** article.

The switch input changes when the switch is pushed down. A stored DTC indicates that the rear defrost switch was stuck in a pushed position for more than 10 minutes, but has since returned to its normal state. An active DTC indicates that the rear defrost switch is stuck in a pushed position.

#### **When Monitored:**

With the ignition on.

#### **Set Condition:**

If the rear defrost switch is detected in a pushed position for more than 10 minutes.

#### **Possible Causes**

OBJECT HOLDING REAR DEFROST SWITCH IN A PUSHED POSITION  
SUBSTANCE CAUSING REAR DEFROST SWITCH TO GET STUCK IN A PUSHED POSITION  
A/C HEATER CONTROL

#### **Diagnostic Test**

##### **1) VERIFY THE DTC IS STILL ACTIVE**

Turn the ignition on.

With the scan tool, erase HVAC DTCs.

Turn the ignition off, wait 10 seconds, and then turn the ignition on. Wait 10 minutes before proceeding.

With the scan tool, read HVAC DTCs.

**Does the scan tool display this DTC?**

**Yes**

Go to 2).



## 2007 Dodge Nitro R/T

2007 HVAC Heating & Air Conditioning - Electrical Diagnostics - Nitro

**No**

The condition that caused this symptom is currently not present. Check for an intermittent condition by inspecting the related wiring harness for chafed, pierced, pinched, and partially broken wires. Also, inspect the related connectors for broken, bent, pushed out, spread, corroded, or contaminated terminals. Repair as necessary.

Perform **BODY VERIFICATION TEST - VER 1** .

### **2) CHECK FOR NORMAL REAR DEFROST SWITCH & STATUS INDICATOR FUNCTION**

Set the Blower control to any position except Off.

Set the Mode control to any position except Auto.

Press the Rear Defrost switch on and off several times while observing the Rear Defrost status indicator.

**Does the Rear Defrost status indicator turn on and off?**

**Yes**

Go to 4).

**No**

Go to 3).

### **3) INSPECT FOR OBJECT OR SUBSTANCE CAUSING THE REAR DEFROST SWITCH TO STAY OR STICK IN A PUSHED POSITION**

Inspect the A/C Heater Control for anything that would cause the Rear Defrost switch to stay or stick in a pushed position.

**Is anything present that would cause the Rear Defrost switch to stay or stick in a pushed position?**

**Yes**

Repair as necessary.

Perform **BODY VERIFICATION TEST - VER 1** .

**No**

Go to 4).

### **4) INSPECT THE A/C HEATER CONTROL FOR DAMAGE**

Inspect the A/C Heater Control for damage.

**Is the A/C Heater Control damaged?**

**2007 Dodge Nitro R/T**

2007 HVAC Heating & Air Conditioning - Electrical Diagnostics - Nitro

**Yes**

Replace the A/C Heater Control in accordance with the service information.

Perform **BODY VERIFICATION TEST - VER 1** .

**No**

Perform **BODY VERIFICATION TEST - VER 1** .

**B1031-EVAPORATOR FIN TEMPERATURE SENSOR CIRCUIT LOW**

# 2007 Dodge Nitro R/T

## 2007 HVAC Heating & Air Conditioning - Electrical Diagnostics - Nitro

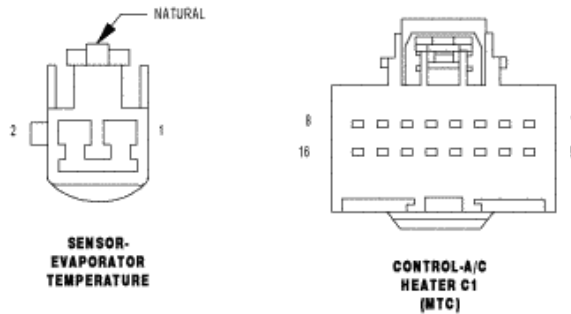
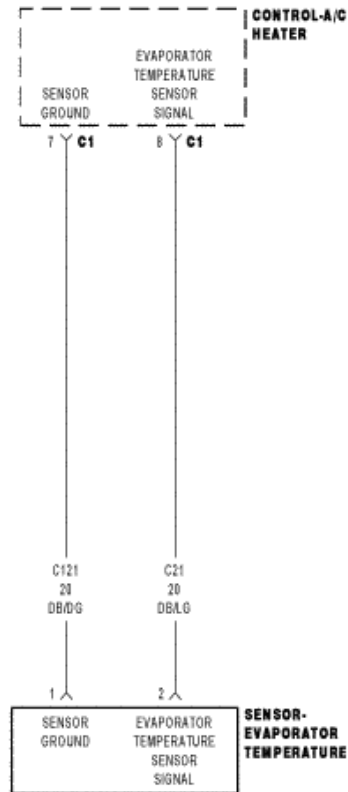

8196016

**Fig. 1: Evaporator Fin Temperature Sensor Circuit Schematic**  
Courtesy of CHRYSLER LLC

For complete wiring diagrams refer to **SYSTEM WIRING DIAGRAMS** article.

**When Monitored:**

## 2007 Dodge Nitro R/T

2007 HVAC Heating & Air Conditioning - Electrical Diagnostics - Nitro

With the ignition on.

### Set Condition:

If the Evaporator Temperature Sensor input is out of range toward the low voltage threshold.

### Possible Causes

(C21) EVAPORATOR TEMPERATURE SENSOR SIGNAL CIRCUIT SHORTED TO GROUND  
EVAPORATOR TEMPERATURE SENSOR  
A/C HEATER CONTROL

### Diagnostic Test

#### 1) ACTIVE DTC(S) PRESENT

Turn the ignition on.

Using the A/C Heater Control, turn the heater on.

With the scan tool, check for DTCs.

**Does the scan tool display this DTC as active?**

**Yes**

Go to 2).

**No**

The condition that caused this symptom is currently not present. Check for an intermittent condition by inspecting the related wiring harness for chafed, pierced, pinched, and partially broken wires. Also, inspect the related connectors for broken, bent, pushed out, spread, corroded, or contaminated terminals. Repair as necessary.

Perform **BODY VERIFICATION TEST - VER 1** .

#### 2) CHECK FOR DTC WITH THE EVAPORATOR TEMPERATURE SENSOR HARNESS CONNECTOR DISCONNECTED

Turn the ignition off.

Disconnect the Evaporator Temperature Sensor Harness Connector.

Turn the ignition on.

With the scan tool, erase HVAC DTCs.

Turn the ignition off, wait 10 seconds, and turn the ignition on.

With the scan tool, read HVAC DTCs.

**Does the scan tool display this DTC as active?**

**Yes**

Go to 3).

**No**

Replace the Evaporator Temperature Sensor in accordance with the service information.

Perform **BODY VERIFICATION TEST - VER 1** .

**3) CHECK (C21) EVAPORATOR TEMPERATURE SENSOR SIGNAL CIRCUIT FOR A SHORT TO GROUND**

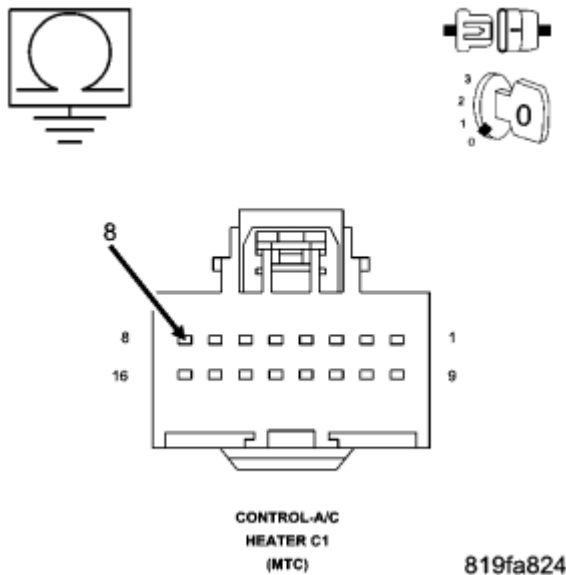

**Fig. 2: Measuring Resistance Between Ground And (C21) Evaporator Temperature Sensor Signal Circuit In A/C Heater Control C1 Harness Connector**  
 Courtesy of CHRYSLER LLC

Turn the ignition off.

Disconnect the A/C Heater Control C1 harness connector.

Measure the resistance between ground and the (C21) Evaporator Temperature Sensor Signal circuit in the A/C Heater Control C1 harness connector.

**Does the ohm meter read open circuit?**

**Yes**

**2007 Dodge Nitro R/T**

2007 HVAC Heating & Air Conditioning - Electrical Diagnostics - Nitro

Replace the A/C Heater Control in accordance with the service information.

Perform **BODY VERIFICATION TEST - VER 1** .

**No**

Repair the (C21) Evaporator Temperature Sensor Signal circuit for a short to ground.

Perform **BODY VERIFICATION TEST - VER 1** .

**B1032-EVAPORATOR FIN TEMPERATURE SENSOR CIRCUIT HIGH**

# 2007 Dodge Nitro R/T

## 2007 HVAC Heating & Air Conditioning - Electrical Diagnostics - Nitro

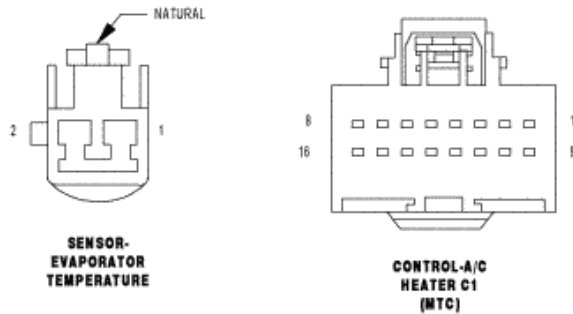
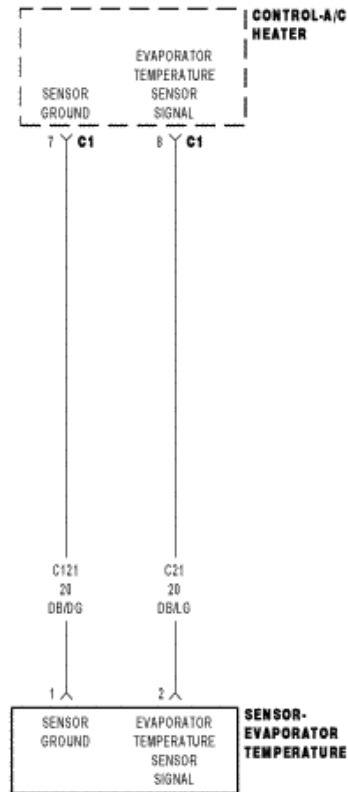

8196016

**Fig. 3: Evaporator Fin Temperature Sensor Circuit Schematic**  
Courtesy of CHRYSLER LLC

For complete wiring diagrams refer to **SYSTEM WIRING DIAGRAMS** article.

**When Monitored:**

## 2007 Dodge Nitro R/T

2007 HVAC Heating & Air Conditioning - Electrical Diagnostics - Nitro

With the ignition on.

### Set Condition:

If the Evaporator Temperature Sensor input is out of range toward the high voltage threshold.

### Possible Causes

(C21) EVAPORATOR TEMPERATURE SENSOR SIGNAL CIRCUIT SHORTED TO VOLTAGE  
(C21) EVAPORATOR TEMPERATURE SENSOR SIGNAL CIRCUIT OPEN  
(C121) SENSOR GROUND CIRCUIT OPEN  
EVAPORATOR TEMPERATURE SENSOR  
A/C HEATER CONTROL

### Diagnostic Test

#### 1) ACTIVE DTC(S) PRESENT

Turn the ignition on.

Using the A/C Heater Control, turn the heater on.

With the scan tool, check for DTCs.

**Does the scan tool display this DTC as active?**

**Yes**

Go to 2).

**No**

The condition that caused this symptom is currently not present. Check for an intermittent condition by inspecting the related wiring harness for chafed, pierced, pinched, and partially broken wires. Also, inspect the related connectors for broken, bent, pushed out, spread, corroded, or contaminated terminals. Repair as necessary.

Perform **BODY VERIFICATION TEST - VER 1** .

**2) CHECK (C21) EVAPORATOR TEMPERATURE SENSOR SIGNAL CIRCUIT FOR A SHORT TO VOLTAGE**



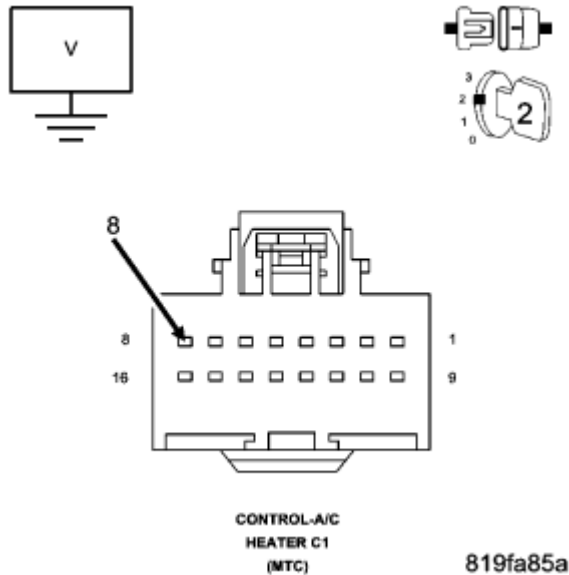

**Fig. 4: Measuring Voltage Of (C21) Evaporator Temperature Sensor Signal Circuit In A/C Heater Control C1 Harness Connector**  
 Courtesy of CHRYSLER LLC

Turn the ignition off.

Disconnect the A/C Heater Control C1 harness connector.

Turn the ignition on.

Measure the voltage of the (C21) Evaporator Temperature Sensor Signal circuit in the A/C Heater Control C1 harness connector.

**Is there any voltage present?**

**Yes**

Repair the (C21) Evaporator Temperature Sensor Signal circuit for a short to voltage.  
 Perform **BODY VERIFICATION TEST - VER 1** .

**No**

Go to 3).

**3) CHECK (C21) EVAPORATOR TEMPERATURE SENSOR SIGNAL CIRCUIT, (C121) SENSOR GROUND CIRCUIT, & EVAPORATOR TEMPERATURE SENSOR**

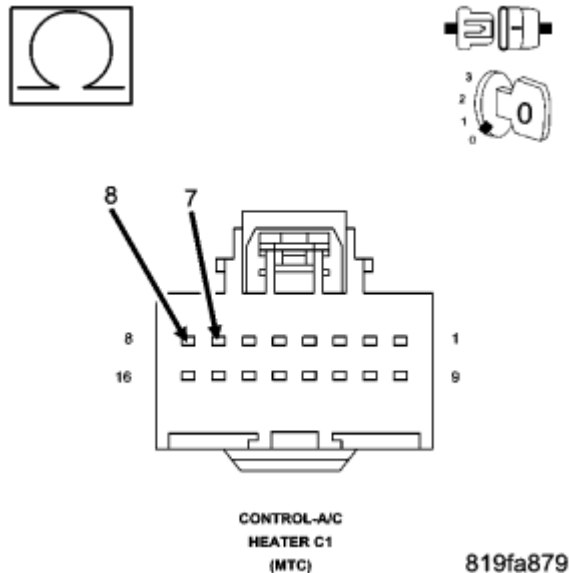

**Fig. 5: Measuring Resistance Between (C21) Evaporator Temperature Sensor Signal Circuit And (C121) Sensor Ground Circuit In A/C Heater Control C1 Harness Connector**  
 Courtesy of CHRYSLER LLC

Turn the ignition off.

Measure the resistance between the (C21) Evaporator Temperature Sensor Signal circuit and the (C121) Sensor Ground circuit in the A/C Heater Control C1 harness connector. The approximate circuit resistance should be as follows:

- 1468 ohms @ 40°C (104°F)
- 1800 ohms @ 35°C (95°F)
- 2221 ohms @ 30°C (86°F)
- 2757 ohms @ 25°C (77°F)
- 3443 ohms @ 20°C (68°F)
- 4330 ohms @ 15°C (59°F)
- 5485 ohms @ 10°C (50°F)
- 6998 ohms @ 5°C (41°F)
- 7354 ohms @ 4°C (39°F)
- 7731 ohms @ 3°C (37°F)
- 8130 ohms @ 2°C (36°F)
- 8553 ohms @ 1°C (34°F)
- 9000 ohms @ 0°C (32°F)

**Is the resistance within the specifications?**

**Yes**

Replace the A/C Heater Control in accordance with the service information.  
Perform **BODY VERIFICATION TEST - VER 1** .

No

Go to 4).

**4) CHECK (C21) EVAPORATOR TEMPERATURE SENSOR SIGNAL CIRCUIT FOR AN OPEN**

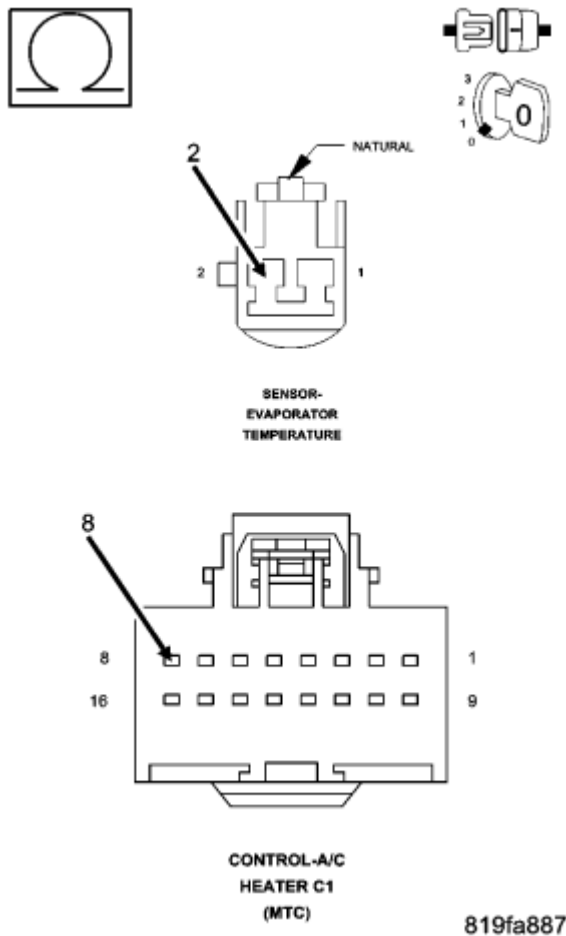

**Fig. 6: Measuring Resistance Of (C21) Evaporator Temperature Sensor Signal Circuit Between A/C Heater Control C1 Harness Connector And Evaporator Temperature Sensor Harness Connector**

Courtesy of CHRYSLER LLC

Disconnect the Evaporator Temperature Sensor harness connector.

Measure the resistance of the (C21) Evaporator Temperature Sensor Signal circuit between the A/C Heater Control C1 harness connector and the Evaporator Temperature Sensor harness connector.

Does the ohm meter read open circuit?

Yes

Repair the (C21) Evaporator Temperature Sensor Signal circuit for an open.  
Perform **BODY VERIFICATION TEST - VER 1** .

No

Go to 5).

**5) CHECK (C121) SENSOR GROUND CIRCUIT FOR AN OPEN**

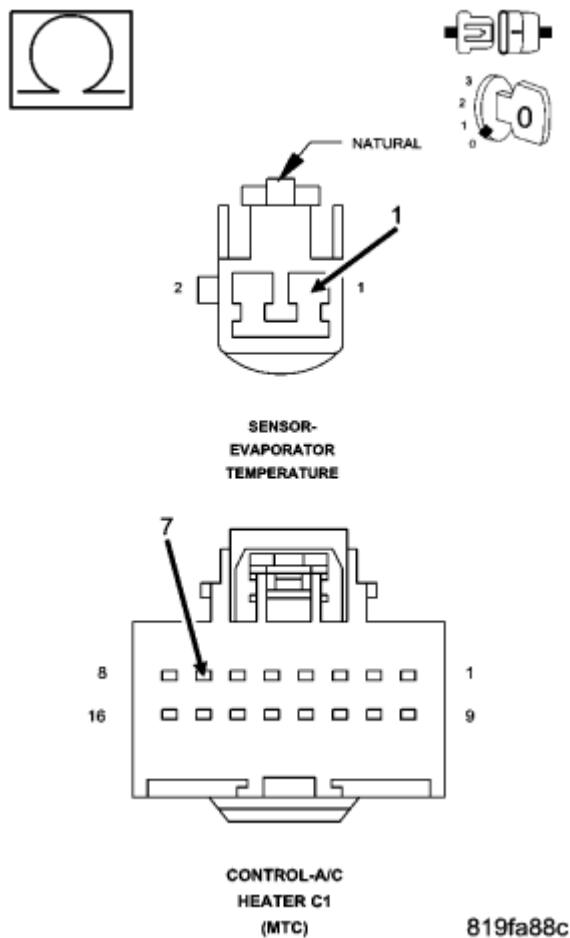

**Fig. 7: Measuring Resistance Of (C121) Sensor Ground Circuit Between A/C Heater Control C1 Harness Connector And Evaporator Temperature Sensor Harness Connector**  
Courtesy of CHRYSLER LLC

Measure the resistance of the (C121) Sensor Ground circuit between the A/C Heater Control C1 harness connector and the Evaporator Temperature Sensor harness connector.

## 2007 Dodge Nitro R/T

2007 HVAC Heating & Air Conditioning - Electrical Diagnostics - Nitro

**Does the ohm meter read open circuit?**

**Yes**

Repair the (C121) Sensor Ground circuit for an open.  
Perform **BODY VERIFICATION TEST - VER 1** .

**No**

Replace the Evaporator Temperature Sensor in accordance with the service information.  
Perform **BODY VERIFICATION TEST - VER 1** .

### **B1034-INFRARED TEMPERATURE SENSOR INPUT CIRCUIT LOW**

For complete wiring diagrams refer to **SYSTEM WIRING DIAGRAMS** article.

**When Monitored:**

With the ignition on.

**Set Condition:**

If the IR Sensor fails the internal self test.

Possible Causes
A/C HEATER CONTROL

**NOTE:** This DTC must be active for the results of this test to be valid. Do not perform this test if this DTC is stored. Refer to HVAC System Test (ATC) for stored DTC test procedures.

Diagnostic Test

**1) REPLACE THE A/C HEATER CONTROL**

**Repair**

Replace the A/C Heater Control in accordance with the service information.  
Perform **BODY VERIFICATION TEST - VER 1** .

### **B1034-INFRARED TEMPERATURE SENSOR THERMISTOR CIRCUIT LOW**

For complete wiring diagrams refer to **SYSTEM WIRING DIAGRAMS** article.

**When Monitored:**

## 2007 Dodge Nitro R/T

2007 HVAC Heating & Air Conditioning - Electrical Diagnostics - Nitro

With the ignition on.

### Set Condition:

If the IR Sensor fails the internal self test.

### Possible Causes

A/C HEATER CONTROL

**NOTE:** This DTC must be active for the results of this test to be valid. Do not perform this test if this DTC is stored. Refer to HVAC System Test (ATC) for stored DTC test procedures.

### Diagnostic Test

1) REPLACE THE A/C HEATER CONTROL

### Repair

Replace the A/C Heater Control in accordance with the service information.

Perform **BODY VERIFICATION TEST - VER 1** .

### B1035-INFRARED TEMPERATURE SENSOR INPUT CIRCUIT HIGH

For complete wiring diagrams refer to **SYSTEM WIRING DIAGRAMS** article.

### When Monitored:

With the ignition on.

### Set Condition:

If the IR Sensor fails the internal self test.

### Possible Causes

A/C HEATER CONTROL

**NOTE:** This DTC must be active for the results of this test to be valid. Do not perform this test if this DTC is stored. Refer to HVAC System Test (ATC) for stored DTC test procedures.

### Diagnostic Test

1) REPLACE THE A/C HEATER CONTROL

## 2007 Dodge Nitro R/T

2007 HVAC Heating & Air Conditioning - Electrical Diagnostics - Nitro

### Repair

Replace the A/C Heater Control in accordance with the service information.

Perform **BODY VERIFICATION TEST - VER 1** .

**B1040-PANEL MODE DOOR 1 CONTROL CIRCUIT/PERFORMANCE**

# 2007 Dodge Nitro R/T

## 2007 HVAC Heating & Air Conditioning - Electrical Diagnostics - Nitro

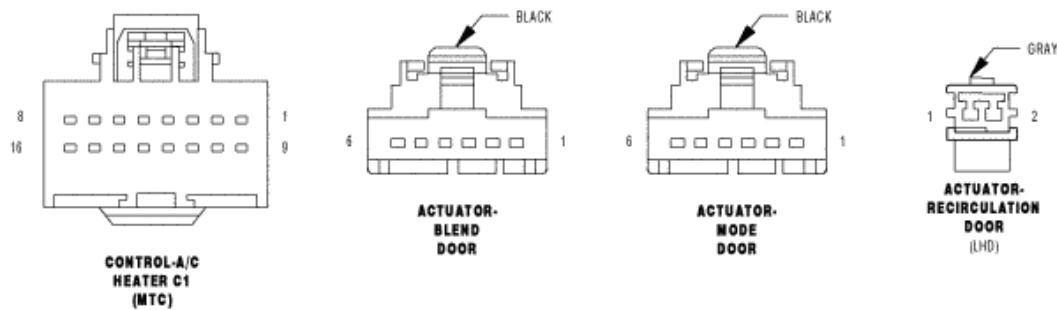
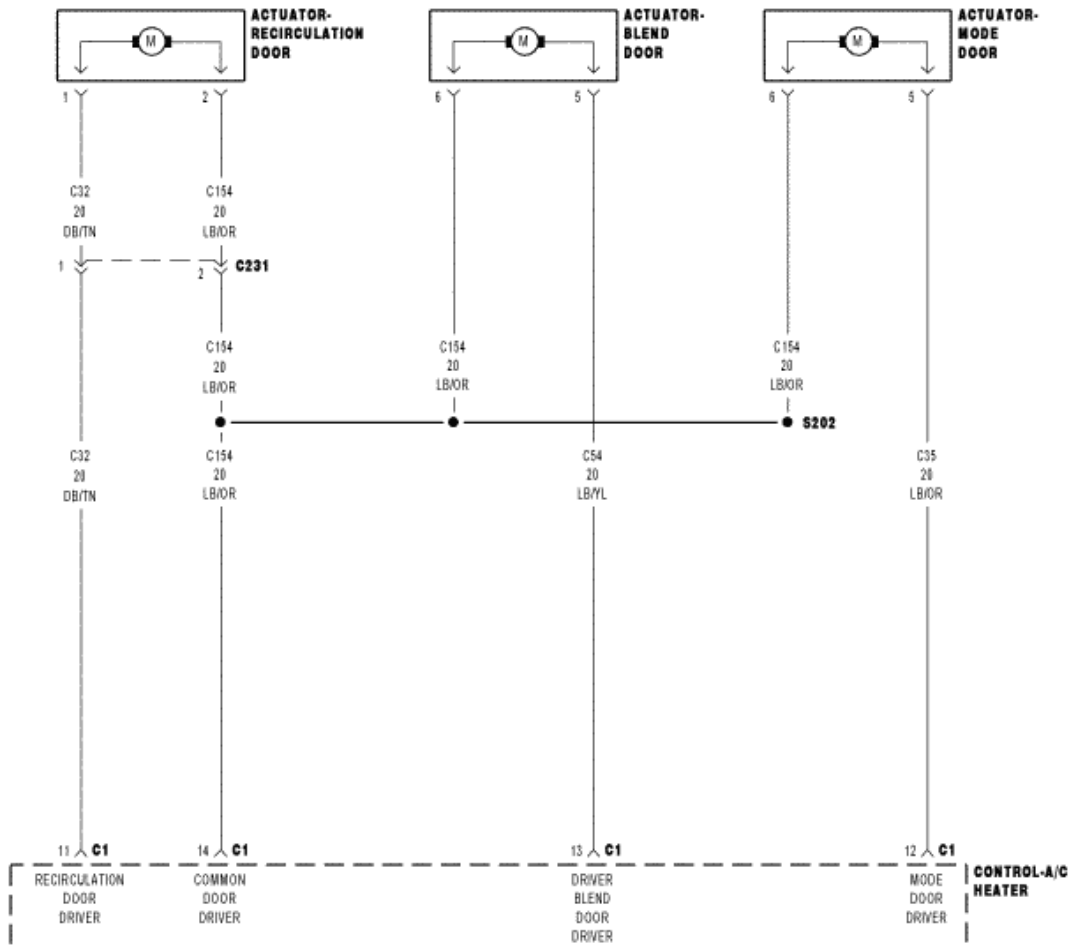

01a25602

**Fig. 8: Panel Mode Door 1 Control Circuit Schematic**  
 Courtesy of CHRYSLER LLC

For complete wiring diagrams refer to **SYSTEM WIRING DIAGRAMS** article.

The A/C Heater Control drives the Mode Door Actuator via the (C35) Mode Door Driver circuit and the (C154)



## 2007 Dodge Nitro R/T

2007 HVAC Heating & Air Conditioning - Electrical Diagnostics - Nitro

Common Door Driver circuit. The Mode Door Actuator shares the (C154) Common Door Driver circuit with the blend door and Recirculation Door Actuators.

### When Monitored:

With the ignition on.

### Set Condition:

If the A/C Heater Control detects a short to ground or to voltage on the (C32) Recirculation Door Driver, the (C54) Blend Door Driver, or the (C154) Common Door Driver circuits while attempting to drive the (C35) Mode Door Driver.

### Possible Causes

(C32) RECIRCULATION DOOR DRIVER CIRCUIT SHORTED TO VOLTAGE  
(C54) BLEND DOOR DRIVER CIRCUIT SHORTED TO VOLTAGE  
(C35) MODE DOOR DRIVER CIRCUIT SHORTED TO VOLTAGE  
(C154) COMMON DOOR DRIVER CIRCUIT SHORTED TO VOLTAGE  
(C32) RECIRCULATION DOOR DRIVER CIRCUIT SHORTED TO GROUND  
(C54) BLEND DOOR DRIVER CIRCUIT SHORTED TO GROUND  
(C35) MODE DOOR DRIVER CIRCUIT SHORTED TO GROUND  
(C154) COMMON DOOR DRIVER CIRCUIT SHORTED TO GROUND  
RECIRCULATION DOOR ACTUATOR  
MODE DOOR ACTUATOR  
BLEND DOOR ACTUATOR  
A/C HEATER CONTROL

### Diagnostic Test

#### 1) ACTIVE DTC(S) PRESENT

Turn the ignition on.

Using the A/C Heater Control, actuate the Mode Door.

With the scan tool, check for DTCs.

**Does the scan tool display this DTC as active?**

**Yes**

Go to 2).

**No**

The condition that caused this symptom is currently not present. Check for an intermittent condition by inspecting the related wiring harness for chafed, pierced, pinched, and partially broken wires. Also, inspect the related connectors for broken, bent, pushed out, spread, corroded, or contaminated terminals. Repair as necessary.

Perform **BODY VERIFICATION TEST - VER 1** .

## 2) CHECK (C32) RECIRCULATION DOOR DRIVER CIRCUIT FOR A SHORT TO VOLTAGE

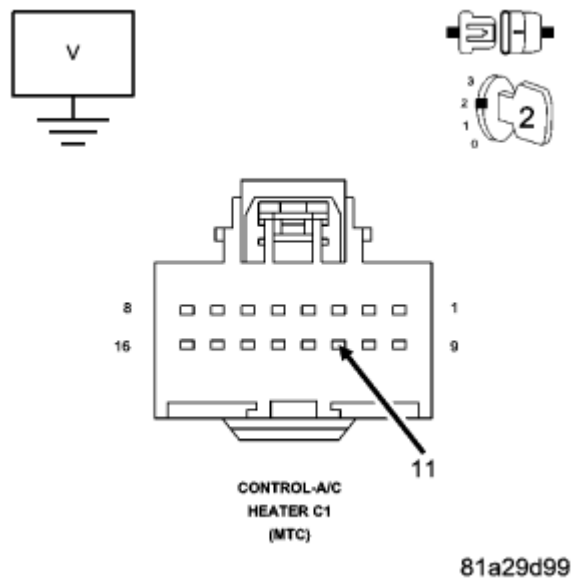

**Fig. 9: Measuring Voltage Of (C32) Recirculation Door Driver Circuit In A/C Heater Control C1 Harness Connector**

Courtesy of CHRYSLER LLC

Turn the ignition off.

Disconnect the A/C Heater Control C1 harness connector.

Turn the ignition on.

Measure the voltage of the (C32) Recirculation Door Driver circuit in the A/C Heater Control C1 harness connector.

**Is there any voltage present?**

**Yes**

Repair the (C32) Recirculation Door Driver circuit for a short to voltage.

Perform **BODY VERIFICATION TEST - VER 1** .

**No**

Go to 3).

### 3) CHECK (C35) MODE DOOR DRIVER CIRCUIT FOR A SHORT TO VOLTAGE

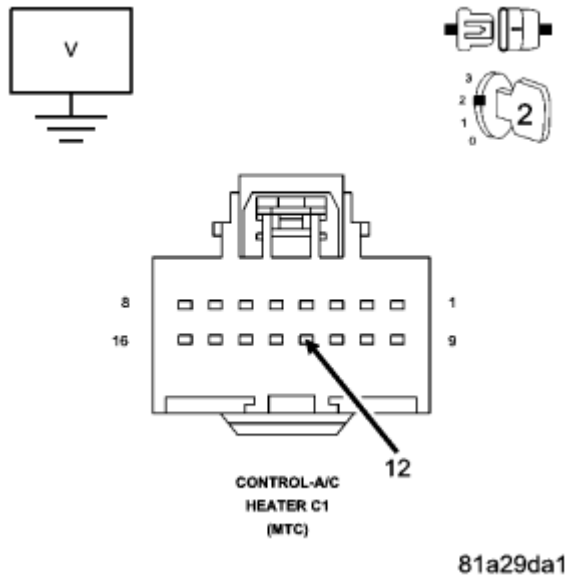

**Fig. 10: Measuring Voltage Of (C35) Mode Door Driver Circuit In A/C Heater Control C1 Harness Connector**

Courtesy of CHRYSLER LLC

Measure the voltage of the (C35) Mode Door Driver circuit in the A/C Heater Control C1 harness connector.

**Is there any voltage present?**

**Yes**

Repair the (C35) Mode Door Driver circuit for a short to voltage.

Perform **BODY VERIFICATION TEST - VER 1** .

**No**

Go to 4).

### 4) CHECK (C54) BLEND DOOR DRIVER CIRCUIT FOR A SHORT TO VOLTAGE

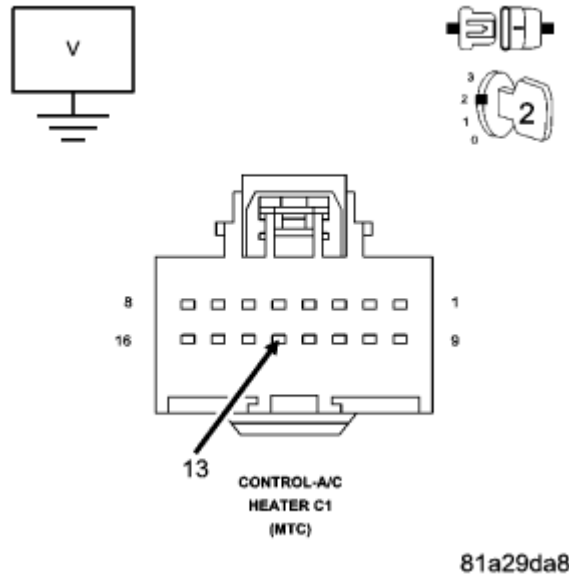

**Fig. 11: Measuring Voltage Of (C54) Blend Door Driver Circuit In A/C Heater Control C1 Harness Connector**

Courtesy of CHRYSLER LLC

Measure the voltage of the (C54) Blend Door Driver circuit in the A/C Heater Control C1 harness connector.

**Is there any voltage present?**

**Yes**

Repair the (C54) Blend Door Driver circuit for a short to voltage.

Perform **BODY VERIFICATION TEST - VER 1** .

**No**

Go to 5).

**5) CHECK (C154) COMMON DOOR DRIVER CIRCUIT FOR A SHORT TO VOLTAGE**

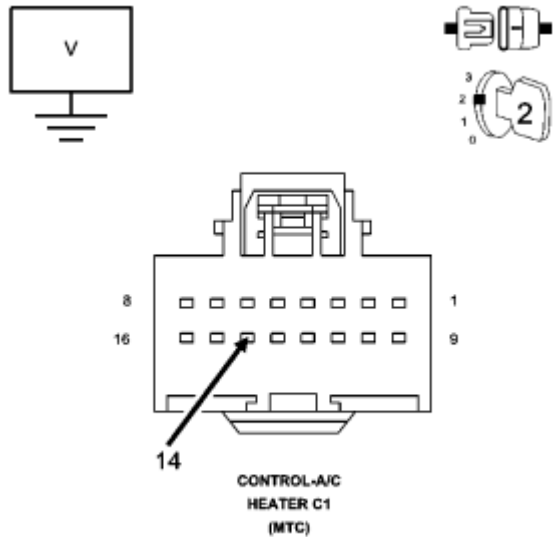

81a29dac

**Fig. 12: Measuring Voltage Of (C154) Common Door Driver Circuit In A/C Heater Control C1 Harness Connector**  
 Courtesy of CHRYSLER LLC

Measure the voltage of the (C154) Common Door Driver circuit in the A/C Heater Control C1 harness connector.

**Is there any voltage present?**

**Yes**

Repair the (C154) Common Door Driver circuit for a short to voltage.  
 Perform **BODY VERIFICATION TEST - VER 1** .

**No**

Go to 6).

**6) CHECK (C32) RECIRCULATION DOOR DRIVER CIRCUIT FOR A SHORT TO GROUND**

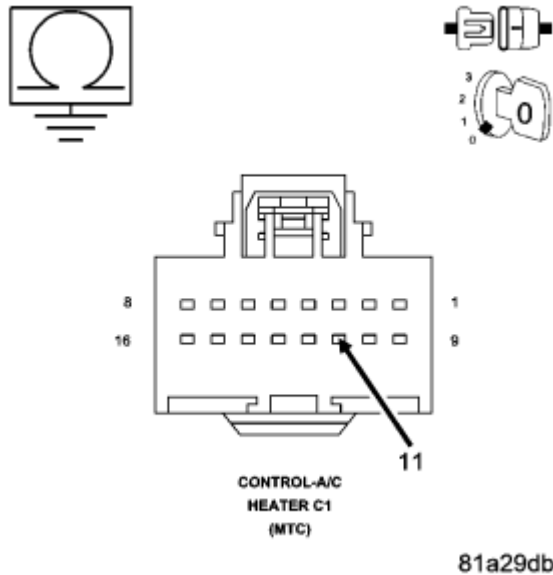

**Fig. 13: Measuring Resistance Between Ground And (C32) Recirculation Door Driver Circuit In A/C Heater Control C1 Harness Connector**  
 Courtesy of CHRYSLER LLC

Turn the ignition off.

Measure the resistance between ground and the (C32) Recirculation Door Driver circuit in the A/C Heater Control C1 harness connector.

**Does the ohm meter read open circuit?**

**Yes**

Go to 7).

**No**

Repair the (C32) Recirculation Door Driver circuit for a short to ground.

Perform **BODY VERIFICATION TEST - VER 1** .

**7) CHECK (C54) DRIVER BLEND DOOR DRIVER CIRCUIT FOR A SHORT TO GROUND**

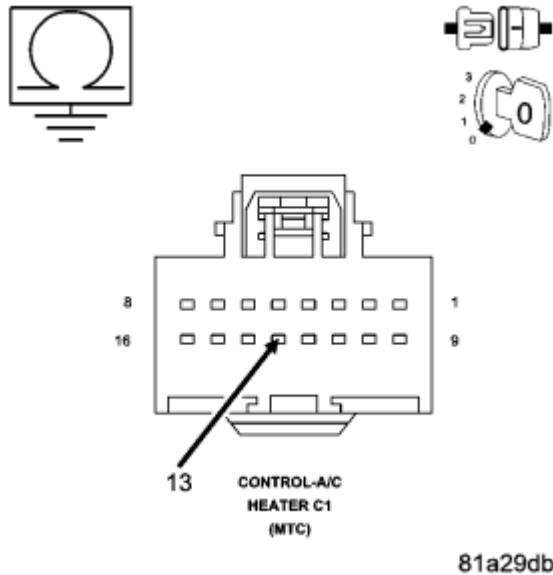

**Fig. 14: Measuring Resistance Between Ground And (C54) Driver Blend Door Driver Circuit In A/C Heater Control C1 Harness Connector**  
 Courtesy of CHRYSLER LLC

Measure the resistance between ground and the (C54) Driver Blend Door Driver circuit in the A/C Heater Control C1 harness connector.

**Does the ohm meter read open circuit?**

**Yes**

Go to 8).

**No**

Repair the (C54) Driver Blend Door Driver circuit for a short to ground.

Perform **BODY VERIFICATION TEST - VER 1** .

**8) CHECK (C35) MODE DOOR DRIVER CIRCUIT FOR A SHORT TO GROUND**

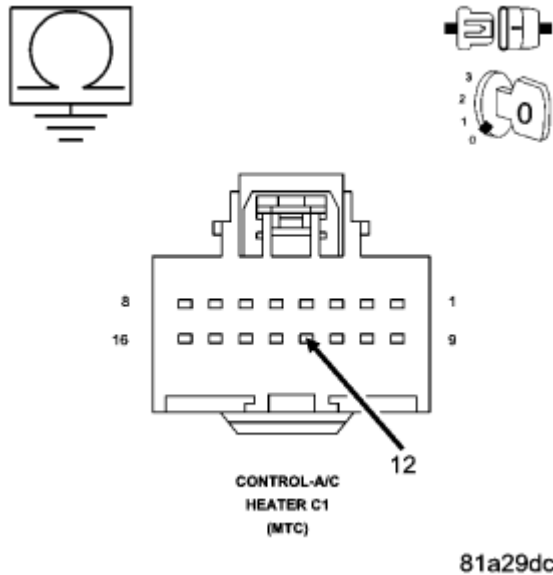

**Fig. 15: Measuring Resistance Between Ground And (C35) Mode Door Driver Circuit In A/C Heater Control C1 Harness Connector**  
 Courtesy of CHRYSLER LLC

Measure the resistance between ground and the (C35) Mode Door Driver circuit in the A/C Heater Control C1 harness connector.

**Does the ohm meter read open circuit?**

**Yes**

Go to 9).

**No**

Repair the (C35) Mode Door Driver circuit for a short to ground.

Perform **BODY VERIFICATION TEST - VER 1** .

**9) CHECK (C154) COMMON DOOR DRIVER CIRCUIT FOR A SHORT TO GROUND**



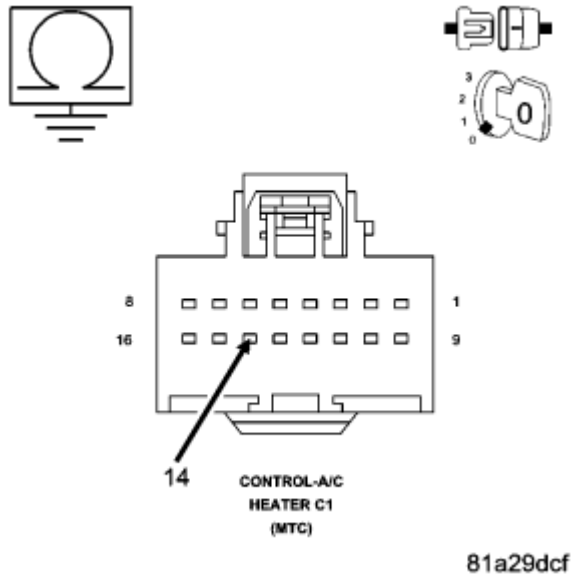

**Fig. 16: Measuring Resistance Between Ground And (C154) Common Door Driver Circuit In A/C Heater Control C1 Harness Connector**  
 Courtesy of CHRYSLER LLC

Measure the resistance between ground and the (C154) Common Door Driver circuit in the A/C Heater Control C1 harness connector.

**Does the ohm meter read open circuit?**

**Yes**

Go to 10).

**No**

Repair the (C154) Common Door Driver circuit for a short to ground.

Perform **BODY VERIFICATION TEST - VER 1** .

**10) CHECK RECIRCULATION DOOR ACTUATOR CIRCUIT RESISTANCE**

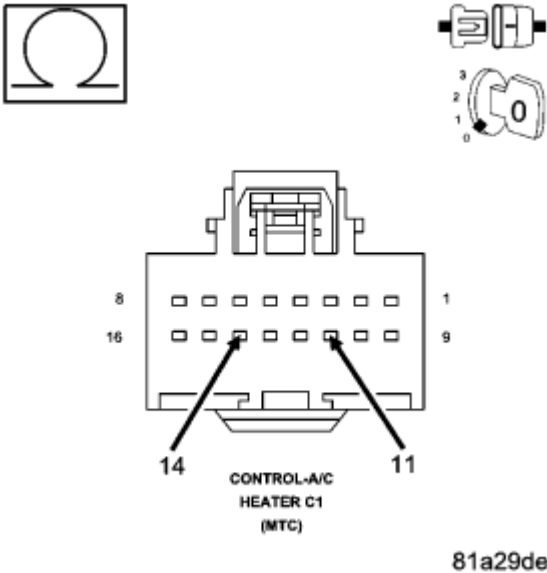

**Fig. 17: Measuring Resistance Between (C32) Recirculation Door Driver Circuit And (C154) Common Door Driver Circuit In A/C Heater Control C1 Harness Connector**  
 Courtesy of CHRYSLER LLC

Measure the resistance between the (C32) Recirculation Door Driver circuit and the (C154) Common Door Driver circuit in the A/C Heater Control C1 harness connector.

**Is the resistance between 30 and 40 ohms?**

**Yes**

Go to 11).

**No**

Replace the Recirculation Door Actuator in accordance with the service information.

Perform **BODY VERIFICATION TEST - VER 1** .

**11) CHECK MODE DOOR ACTUATOR CIRCUIT RESISTANCE**

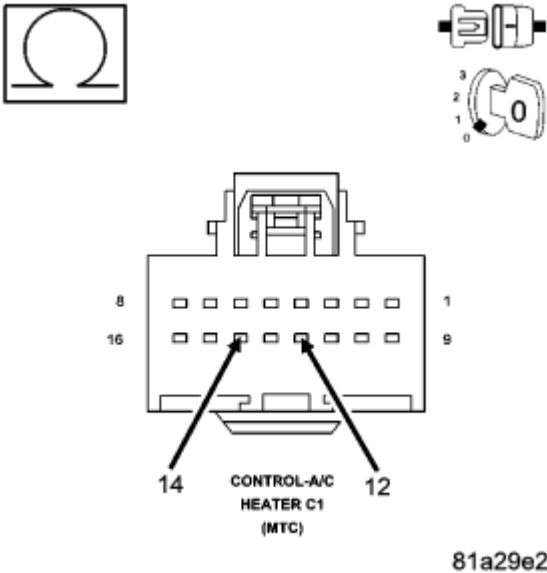

**Fig. 18: Measuring Resistance Between (C35) Mode Door Driver Circuit And (C154) Common Door Driver Circuit In A/C Heater Control C1 Harness Connector**  
Courtesy of CHRYSLER LLC

Measure the resistance between the (C35) Mode Door Driver circuit and the (C154) Common Door Driver circuit in the A/C Heater Control C1 harness connector.

**Is the resistance between 30 and 40 ohms?**

**Yes**

Go to 12).

**No**

Replace the Mode Door Actuator in accordance with the service information.

Perform **BODY VERIFICATION TEST - VER 1** .

**12) CHECK BLEND DOOR ACTUATOR CIRCUIT RESISTANCE**

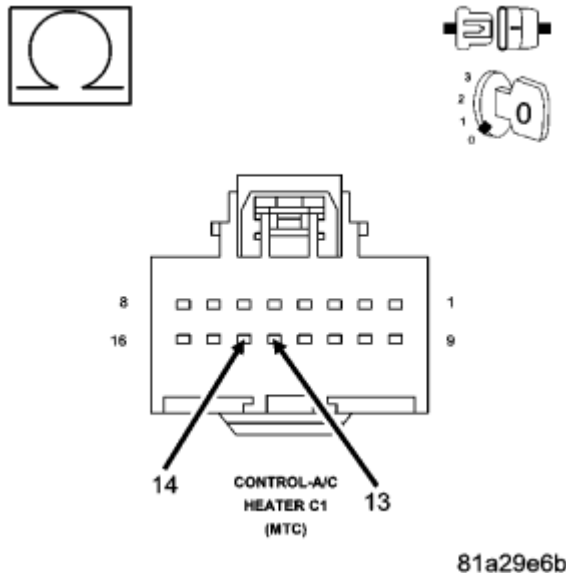

**Fig. 19: Measuring Resistance Between (C54) Blend Door Driver Circuit And (C154) Common Door Driver Circuit In A/C Heater Control C1 Harness Connector**  
 Courtesy of CHRYSLER LLC

Measure the resistance between the (C54) Blend Door Driver circuit and the (C154) Common Door Driver circuit in the A/C Heater Control C1 harness connector.

**Is the resistance between 30 and 40 ohms?**

**Yes**

Go to 13).

**No**

Replace the Blend Door Actuator in accordance with the service information.

Perform **BODY VERIFICATION TEST - VER 1** .

### **13) RUN THE ACTUATOR CALIBRATION TEST**

Reconnect the A/C Heater Control C1 harness connector.

Turn the ignition on.

With the scan tool, erase HVAC DTCs.

Turn the ignition off, wait 10 seconds, and then turn the ignition on.

With the scan tool, select System Tests and then select Actuator Calibration Test. When the test is complete, select View DTCs.

## 2007 Dodge Nitro R/T

2007 HVAC Heating & Air Conditioning - Electrical Diagnostics - Nitro

**Does the scan tool only display: B1040-PANEL MODE DOOR 1 CONTROL CIRCUIT/PERFORMANCE?**

**Yes**

Replace the A/C Heater Control in accordance with the service information.  
Perform **BODY VERIFICATION TEST - VER 1** .

**No, Other DTC(s) Displayed**

Diagnose and repair the other DTC(s). Refer to the **DIAGNOSTIC CODE INDEX** for a complete list of all HVAC related symptoms.

**No, And No Other DTCs Displayed**

Using the wiring diagram as a guide, inspect the wiring and connectors for conditions causing an intermittent short. Repair as necessary.

Perform **BODY VERIFICATION TEST - VER 1** .

**B1043-PANEL MODE DOOR 1 CONTROL CIRCUIT OPEN**

# 2007 Dodge Nitro R/T

## 2007 HVAC Heating & Air Conditioning - Electrical Diagnostics - Nitro

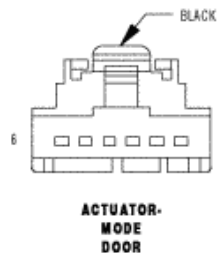
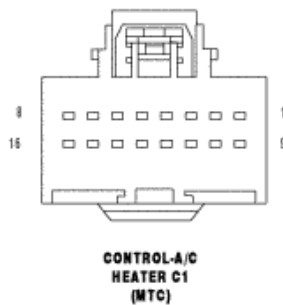
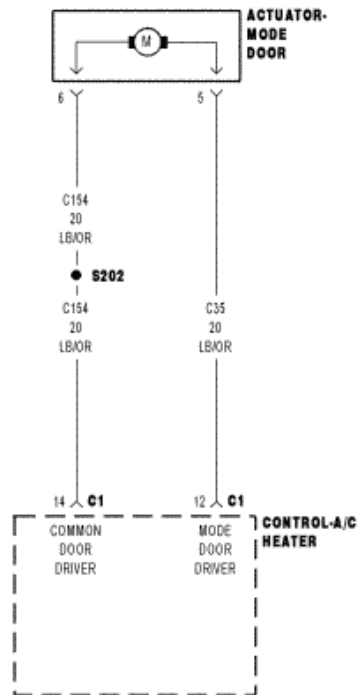

8196641

**Fig. 20: Panel Mode Door 1 Control Circuit Schematic**  
Courtesy of CHRYSLER LLC

For complete wiring diagrams refer to **SYSTEM WIRING DIAGRAMS** article.

The A/C Heater Control drives the Mode Door Actuator via the (C35) Mode Door Driver circuit and the (C154)

## 2007 Dodge Nitro R/T

2007 HVAC Heating & Air Conditioning - Electrical Diagnostics - Nitro

Common Door Driver circuit.

### When Monitored:

With the ignition on.

### Set Condition:

If Mode Door Actuator's electrical circuit is open.

### Possible Causes

(C35) MODE DOOR DRIVER CIRCUIT OPEN  
(C154) COMMON DOOR DRIVER CIRCUIT OPEN  
MODE DOOR ACTUATOR  
A/C HEATER CONTROL

### Diagnostic Test

#### 1) ACTIVE DTC(S) PRESENT

Turn the ignition on.

Using the A/C Heater Control, actuate the Panel Mode Door.

With the scan tool, check for DTCs.

**Does the scan tool display this DTC as active?**

**Yes**

Go to 2).

**No**

The condition that caused this symptom is currently not present. Check for an intermittent condition by inspecting the related wiring harness for chafed, pierced, pinched, and partially broken wires. Also, inspect the related connectors for broken, bent, pushed out, spread, corroded, or contaminated terminals. Repair as necessary.

Perform **BODY VERIFICATION TEST - VER 1** .

#### 2) CHECK (C154) COMMON DOOR DRIVER CIRCUIT FOR AN OPEN

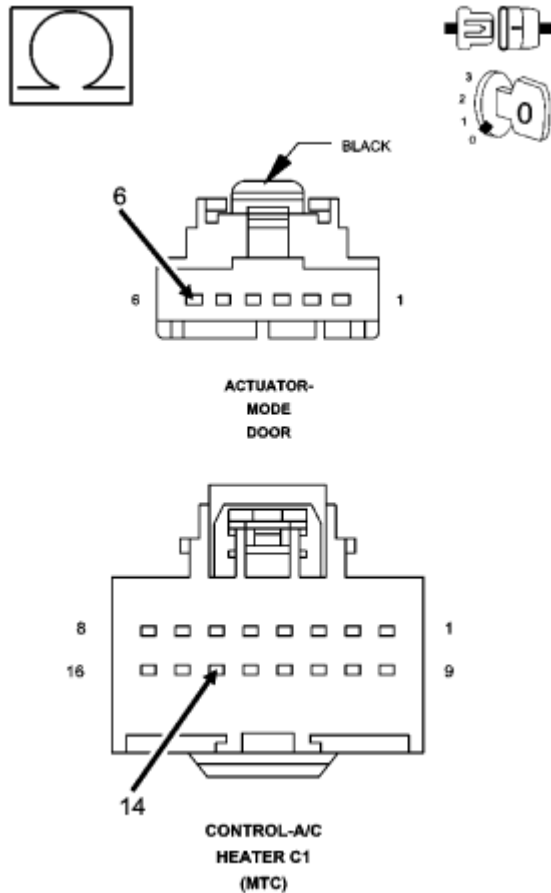

819faa45

**Fig. 21: Measuring Resistance Of (C154) Common Door Driver Circuit Between A/C Heater Control C1 Harness Connector And Mode Door Actuator Harness Connector**  
 Courtesy of CHRYSLER LLC

Turn the ignition off.

Disconnect the A/C Heater Control C1 harness connector.

Disconnect the Mode Door Actuator harness connector.

Measure the resistance of the (C154) Common Door Driver circuit between the A/C Heater Control C1 harness connector and the Mode Door Actuator harness connector.

**Does the ohm meter read open circuit?**

**Yes**

Repair the (C154) Common Door Driver circuit for an open.

Perform **BODY VERIFICATION TEST - VER 1** .



No

Go to 3).

### 3) CHECK (C35) MODE DOOR DRIVER CIRCUIT FOR AN OPEN

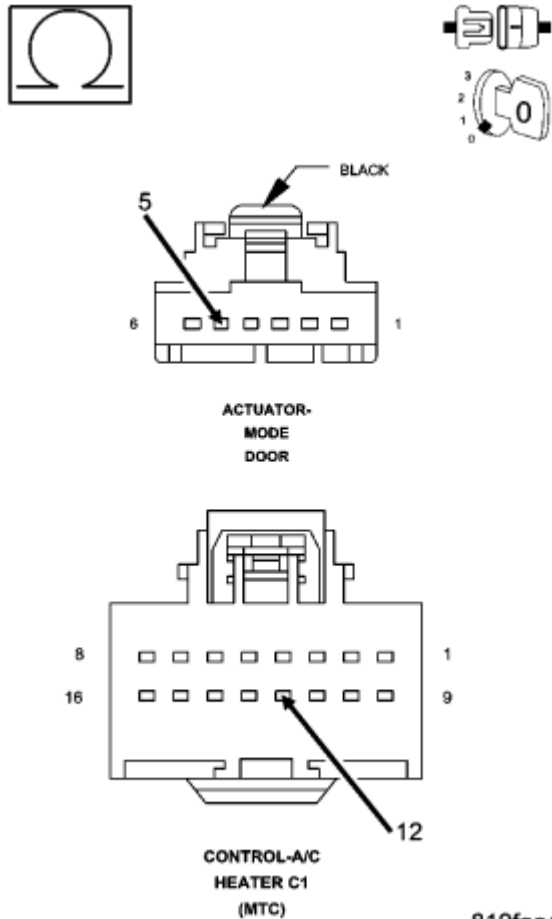

**Fig. 22: Measuring Resistance Of (C35) Mode Door Driver Circuit Between A/C Heater Control C1 Harness Connector And Mode Door Actuator Harness Connector**  
 Courtesy of CHRYSLER LLC

Measure the resistance of the (C35) Mode Door Driver circuit between the A/C Heater Control C1 harness connector and the Mode Door Actuator harness connector.

**Does the ohm meter read open circuit?**

Yes

Repair the (C35) Mode Door Driver circuit for an open.

Perform **BODY VERIFICATION TEST - VER 1** .

No

Go to 4).

#### 4) CHECK MODE DOOR ACTUATOR CIRCUIT RESISTANCE

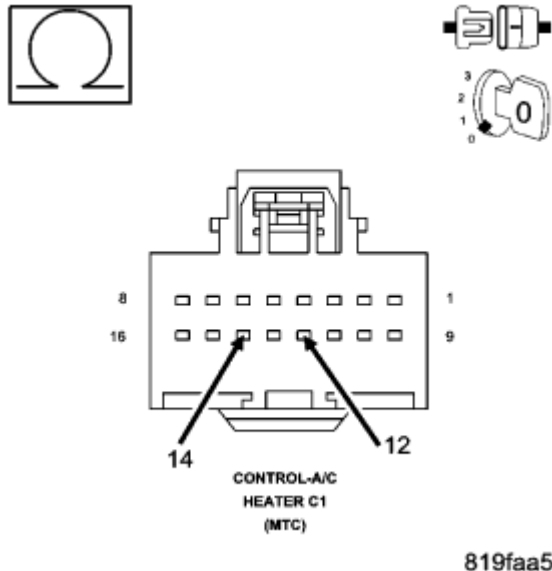

**Fig. 23: Measuring Resistance Between (C35) Mode Door Driver Circuit And (C154) Common Door Driver Circuit In A/C Heater Control C1 Harness Connector**  
 Courtesy of CHRYSLER LLC

Reconnect the Mode Door Actuator harness connector.

Measure the resistance between the (C35) Mode Door Driver circuit and the (C154) Common Door Driver circuit in the A/C Heater Control C1 harness connector.

**Is the resistance between 30 and 40 ohms?**

Yes

Replace the A/C Heater Control in accordance with the service information.

No

Replace the Mode Door Actuator in accordance with the service information.  
 Perform **BODY VERIFICATION TEST - VER 1** .

#### **B1044-PANEL MODE DOOR 1 TRAVEL RANGE TOO SMALL**

For complete wiring diagrams refer to **SYSTEM WIRING DIAGRAMS** article.

## 2007 Dodge Nitro R/T

2007 HVAC Heating & Air Conditioning - Electrical Diagnostics - Nitro

The A/C Heater Control calibrates each actuator individually. Automatic calibration occurs upon power up after installing a new A/C Heater Control. Manual calibration occurs by sending a command with the scan tool. The purpose of actuator calibration is to determine the total span of door travel between physical stops. To calibrate the actuator, the A/C Heater Control first moves the door to its soft stop, and then counts the number of pulses it takes to move the door to its other stop. An expected range of span is stored in the control's memory. If the measured calibration value is less than the expected range for this actuator, this DTC will set. Note that the control clears all stored calibration faults at the beginning of the calibration procedure.

### When Monitored:

During actuator calibration.

### Set Condition:

If the total span of the Mode Door is less than the low range limit.

### Possible Causes

DOOR DRIVER ELECTRICAL CIRCUIT(S)  
MODE DOOR SEIZED, BINDING, OBSTRUCTED  
MODE DOOR ACTUATOR  
A/C HEATER CONTROL

### Diagnostic Test

#### 1) CHECK FOR ACTIVE CONTROL CIRCUIT/PERFORMANCE & CONTROL CIRCUIT OPEN DTCs

Turn the ignition on.

With the scan tool, read active HVAC DTCs.

#### Does the scan tool display any active CONTROL CIRCUIT/PERFORMANCE or CONTROL CIRCUIT OPEN DTCs?

**Yes**

Diagnose and repair the DTC(s). If present, diagnose and repair all Rear Blend and Rear Mode Door Control Circuit/Performance DTCs first, all other Control Circuit/Performance DTCs second, and all Control Circuit Open DTCs last. Refer to the **DIAGNOSTIC CODE INDEX** for a complete list of all HVAC related symptoms.

**No**

Go to 2).

#### 2) INSPECT ACTUATOR & HOUSING ASSEMBLY FOR A CONDITION CAUSING THE DOOR TO SEIZE OR BIND

Turn the ignition off.

Inspect the actuator, linkage, and housing assembly for a condition causing the door to seize or bind.

**Are there any physical or mechanical problems with the door, housing, linkage, or actuator?**

**Yes**

Repair as necessary in accordance with the service information.

Perform **BODY VERIFICATION TEST - VER 1** .

**No**

Go to 3).

### **3) CHECK MODE DOOR TRAVEL**

Remove the Mode Door Actuator from the A/C Heater Housing Assembly.

By hand, attempt to rotate the door in both directions. The door should operate smoothly in both directions over approximately 90 degrees of travel.

**Does the door operate smoothly in both directions over approximately 90 degrees of travel?**

**Yes**

Replace the Mode Door Actuator in accordance with the service information. Then, go to 4).

**No**

Repair as necessary in accordance with the service information.

Perform **BODY VERIFICATION TEST - VER 1** .

### **4) RUN THE ACTUATOR CALIBRATION TEST**

Turn the ignition on.

With the scan tool, select System Tests and then select Actuator Calibration Test. When the test is complete, select View DTCs.

**Does the scan tool display this DTC as active?**

**Yes**

Replace the A/C Heater Control in accordance with the service information.

Perform **BODY VERIFICATION TEST - VER 1** .

**No**

Perform **BODY VERIFICATION TEST - VER 1** .

**B1045-PANEL MODE DOOR 1 TRAVEL RANGE TOO LARGE**

For complete wiring diagrams refer to **SYSTEM WIRING DIAGRAMS** article.

The A/C Heater Control calibrates each actuator individually. Automatic calibration occurs upon power up after installing a new A/C Heater Control. Manual calibration occurs by sending a command with the scan tool. The purpose of actuator calibration is to determine the total span of door travel between physical stops. To calibrate the actuator, the A/C Heater Control first moves the door to its soft stop, and then counts the number of pulses it takes to move the door to its other stop. An expected range of span is stored in the control's memory. If the measured calibration value exceeds the expected range for this actuator, this DTC will set. Note that the control clears all stored calibration faults at the beginning of the calibration procedure.

**When Monitored:**

During actuator calibration.

**Set Condition:**

If the total span of the Mode 1 (Floor to Panel) Door exceeds the high range limit.

**Possible Causes**

DOOR DRIVER ELECTRICAL CIRCUIT(S)  
MODE DOOR OR A/C HEATER HOUSING COMPONENTS WARPED, WORN, DAMAGED,  
MISSING, BROKEN  
MODE DOOR 1 (FLOOR TO PANEL) ACTUATOR  
A/C HEATER CONTROL

**Diagnostic Test****1) CHECK FOR ACTIVE CONTROL CIRCUIT/PERFORMANCE & CONTROL CIRCUIT OPEN DTCs**

Turn the ignition on.

With the scan tool, read active HVAC DTCs.

**Does the scan tool display any active CONTROL CIRCUIT/PERFORMANCE or CONTROL CIRCUIT OPEN DTCs?**

**Yes**

Diagnose and repair the DTC(s). If present, diagnose and repair all Rear Blend and Rear Mode

Door Control Circuit/Performance DTCs first, all other Control Circuit/Performance DTCs second, and all Control Circuit Open DTCs last. Refer to the **DIAGNOSTIC CODE INDEX** for a complete list of all HVAC related symptoms.

**No**

Go to 2).

**2) CHECK FOR A BROKEN MODE DOOR 1 (FLOOR TO PANEL) ACTUATOR**

Turn the ignition off.

Remove the Mode Door 1 (Floor to Panel) Actuator from the A/C Heater Housing Assembly.

By hand, attempt to rotate the actuator in both directions.

**Does the actuator turn in either direction?**

**Yes**

Replace the Mode Door 1 (Floor to Panel) Actuator in accordance with the service information.  
Perform **BODY VERIFICATION TEST - VER 1** .

**No**

Go to 3).

**3) CHECK MODE 1 (FLOOR TO PANEL) DOOR & A/C HEATER HOUSING FOR WARPED, WORN, DAMAGED, MISSING, & BROKEN COMPONENTS**

Inspect for excessively worn, disconnected, missing, or broken door linkage. Inspect for a damaged or broken A/C Heater Housing Assembly. Inspect for a warped or broken door, and missing door seals. Rotate the door from stop to stop. The door should rotate approximately 90 degrees.

**Are there any physical or mechanical problems with the door or housing?**

**Yes**

Repair as necessary in accordance with the service information.  
Perform **BODY VERIFICATION TEST - VER 1** .

**No**

Replace the Mode Door 1 (Floor to Panel) Actuator in accordance with the service information.  
Then, go to 4).

**4) RUN THE ACTUATOR CALIBRATION TEST**

## 2007 Dodge Nitro R/T

2007 HVAC Heating & Air Conditioning - Electrical Diagnostics - Nitro

Turn the ignition on.

With the scan tool, select System Tests and then select Actuator Calibration Test. When the test is complete, select View DTCs.

**Does the scan tool display this DTC as active?**

**Yes**

Replace the A/C Heater Control in accordance with the service information.

Perform **BODY VERIFICATION TEST - VER 1** .

**No**

Perform **BODY VERIFICATION TEST - VER 1** .

**B1058-RECIRCULATION DOOR CONTROL CIRCUIT/PERFORMANCE**

# 2007 Dodge Nitro R/T

## 2007 HVAC Heating & Air Conditioning - Electrical Diagnostics - Nitro

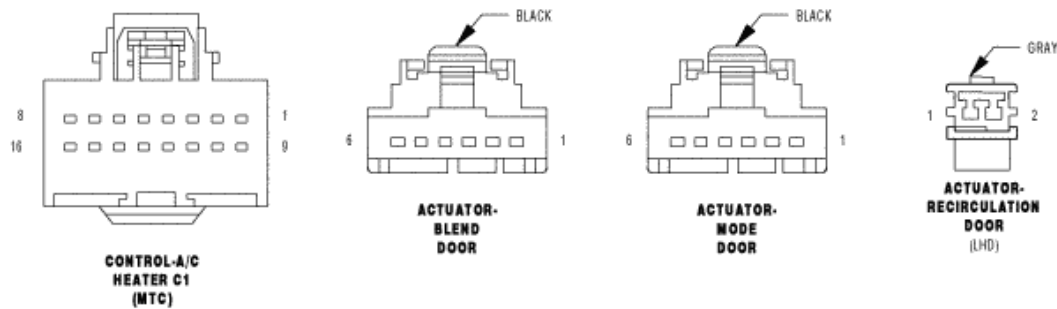
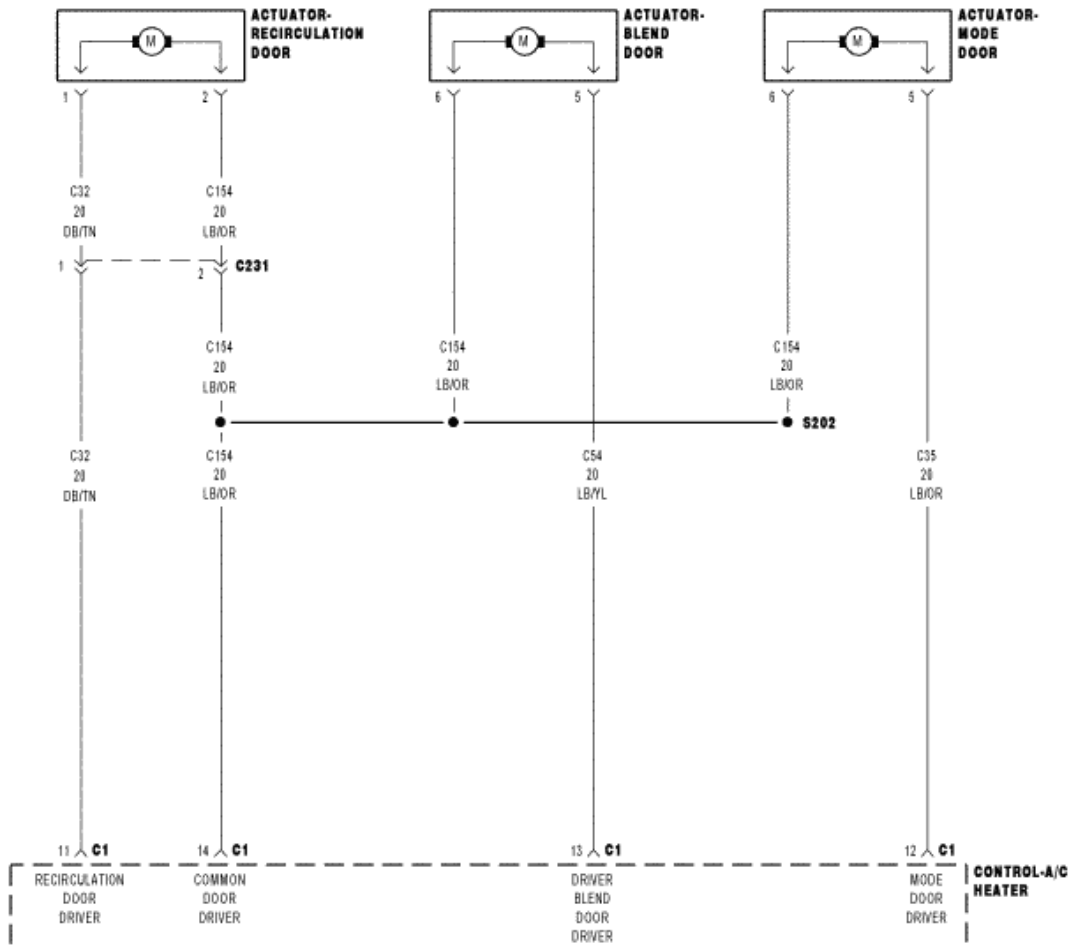

01a25602

**Fig. 24: Recirculation Door Control Circuit Schematic**  
 Courtesy of CHRYSLER LLC

For complete wiring diagrams refer to **SYSTEM WIRING DIAGRAMS** article.

The A/C Heater Control drives the Recirculation Door Actuator via the (C32) Recirculation Door Driver and



## 2007 Dodge Nitro R/T

2007 HVAC Heating & Air Conditioning - Electrical Diagnostics - Nitro

the (C154) Common Door Driver.

### When Monitored:

With the ignition on.

### Set Condition:

If the A/C Heater Control detects a short to ground or to voltage on the (C32) Recirculation Door Driver, the (C54) Blend Door Driver, the (C35) Mode Door Driver, or the (C154) Common Door Driver circuits while attempting to drive the (C32) Recirculation Door Driver.

### Possible Causes

(C32) RECIRCULATION DOOR DRIVER CIRCUIT SHORTED TO VOLTAGE  
(C54) BLEND DOOR DRIVER CIRCUIT SHORTED TO VOLTAGE  
(C35) MODE DOOR DRIVER CIRCUIT SHORTED TO VOLTAGE  
(C154) COMMON DOOR DRIVER CIRCUIT SHORTED TO VOLTAGE  
(C32) RECIRCULATION DOOR DRIVER CIRCUIT SHORTED TO GROUND  
(C54) BLEND DOOR DRIVER CIRCUIT SHORTED TO GROUND  
(C35) MODE DOOR DRIVER CIRCUIT SHORTED TO GROUND  
(C154) COMMON DOOR DRIVER CIRCUIT SHORTED TO GROUND  
RECIRCULATION DOOR ACTUATOR  
MODE DOOR ACTUATOR  
BLEND DOOR ACTUATOR  
A/C HEATER CONTROL

### Diagnostic Test

#### 1) ACTIVE DTC(S) PRESENT

Turn the ignition on.

Using the A/C Heater Control, actuate the Recirculation Door.

With the scan tool, check for DTCs.

**Does the scan tool display this DTC as active?**

**Yes**

Go to 2).

**No**

The condition that caused this symptom is currently not present. Check for an intermittent

condition by inspecting the related wiring harness for chafed, pierced, pinched, and partially broken wires. Also, inspect the related connectors for broken, bent, pushed out, spread, corroded, or contaminated terminals. Repair as necessary.

Perform **BODY VERIFICATION TEST - VER 1** .

## 2) CHECK (C32) RECIRCULATION DOOR DRIVER CIRCUIT FOR A SHORT TO VOLTAGE

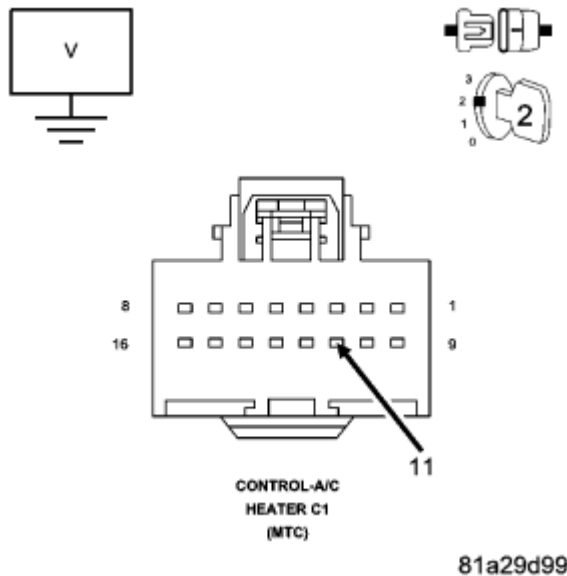

**Fig. 25: Measuring Voltage Of (C32) Recirculation Door Driver Circuit In A/C Heater Control C1 Harness Connector**

Courtesy of CHRYSLER LLC

Turn the ignition off.

Disconnect the A/C Heater Control C1 harness connector.

Turn the ignition on.

Measure the voltage of the (C32) Recirculation Door Driver circuit in the A/C Heater Control C1 harness connector.

**Is there any voltage present?**

**Yes**

Repair the (C32) Recirculation Door Driver circuit for a short to voltage.

Perform **BODY VERIFICATION TEST - VER 1** .

**No**

Go to 3).

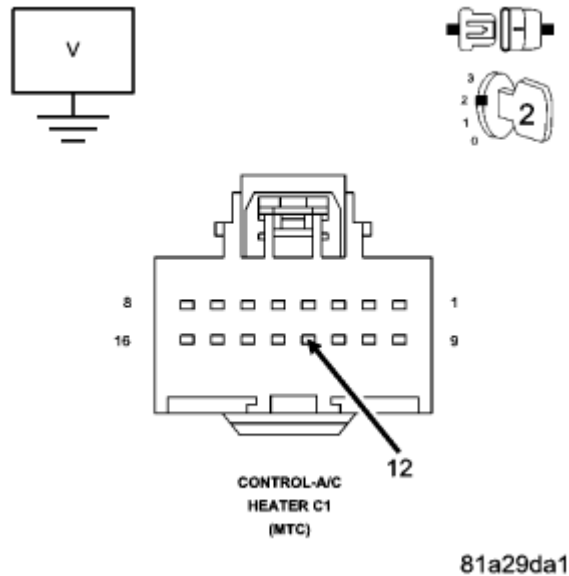
**3) CHECK (C35) MODE DOOR DRIVER CIRCUIT FOR A SHORT TO VOLTAGE**

**Fig. 26: Measuring Voltage Of (C35) Mode Door Driver Circuit In A/C Heater Control C1 Harness Connector**

Courtesy of CHRYSLER LLC

Measure the voltage of the (C35) Mode Door Driver circuit in the A/C Heater Control C1 harness connector.

**Is there any voltage present?**

**Yes**

Repair the (C35) Mode Door Driver circuit for a short to voltage.

Perform **BODY VERIFICATION TEST - VER 1** .

**No**

Go to 4).

**4) CHECK (C54) BLEND DOOR DRIVER CIRCUIT FOR A SHORT TO VOLTAGE**

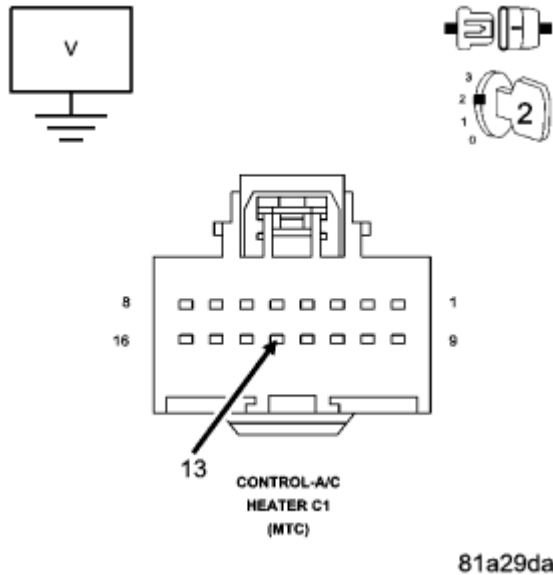

**Fig. 27: Measuring Voltage Of (C54) Blend Door Driver Circuit In A/C Heater Control C1 Harness Connector**

Courtesy of CHRYSLER LLC

Measure the voltage of the (C54) Blend Door Driver circuit in the A/C Heater Control C1 harness connector.

**Is there any voltage present?**

**Yes**

Repair the (C54) Blend Door Driver circuit for a short to voltage.

Perform **BODY VERIFICATION TEST - VER 1** .

**No**

Go to 5).

**5) CHECK (C154) COMMON DOOR DRIVER CIRCUIT FOR A SHORT TO VOLTAGE**

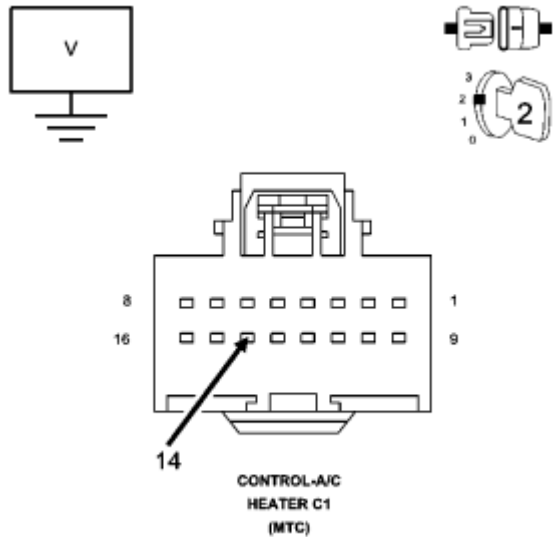

81a29dac

**Fig. 28: Measuring Voltage Of (C154) Common Door Driver Circuit In A/C Heater Control C1 Harness Connector**  
 Courtesy of CHRYSLER LLC

Measure the voltage of the (C154) Common Door Driver circuit in the A/C Heater Control C1 harness connector.

**Is there any voltage present?**

**Yes**

Repair the (C154) Common Door Driver circuit for a short to voltage.  
 Perform **BODY VERIFICATION TEST - VER 1** .

**No**

Go to 6).

**6) CHECK (C32) RECIRCULATION DOOR DRIVER CIRCUIT FOR A SHORT TO GROUND**

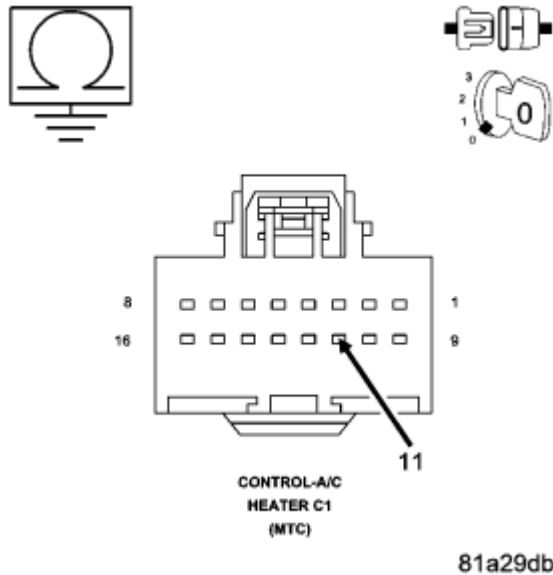

**Fig. 29: Measuring Resistance Between Ground And (C32) Recirculation Door Driver Circuit In A/C Heater Control C1 Harness Connector**  
 Courtesy of CHRYSLER LLC

Turn the ignition off.

Measure the resistance between ground and the (C32) Recirculation Door Driver circuit in the A/C Heater Control C1 harness connector.

**Does the ohm meter read open circuit?**

**Yes**

Go to 7).

**No**

Repair the (C32) Recirculation Door Driver circuit for a short to ground.

Perform **BODY VERIFICATION TEST - VER 1** .

**7) CHECK (C54) DRIVER BLEND DOOR DRIVER CIRCUIT FOR A SHORT TO GROUND**

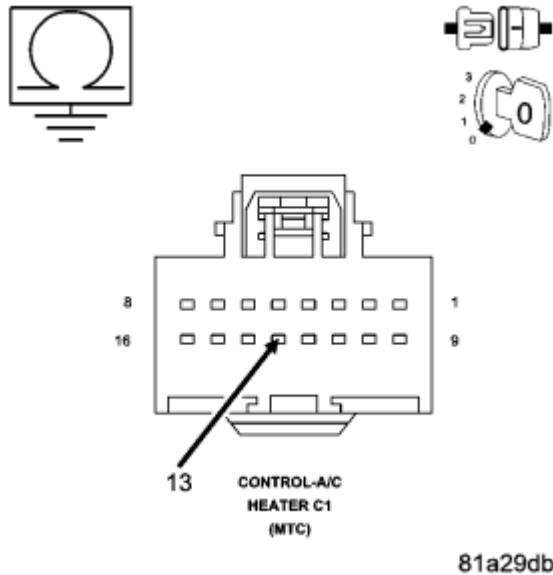

**Fig. 30: Measuring Resistance Between Ground And (C54) Driver Blend Door Driver Circuit In A/C Heater Control C1 Harness Connector**  
 Courtesy of CHRYSLER LLC

Measure the resistance between ground and the (C54) Driver Blend Door Driver circuit in the A/C Heater Control C1 harness connector.

**Does the ohm meter read open circuit?**

**Yes**

Go to 8).

**No**

Repair the (C54) Driver Blend Door Driver circuit for a short to ground.

Perform **BODY VERIFICATION TEST - VER 1** .

**8) CHECK (C35) MODE DOOR DRIVER CIRCUIT FOR A SHORT TO GROUND**

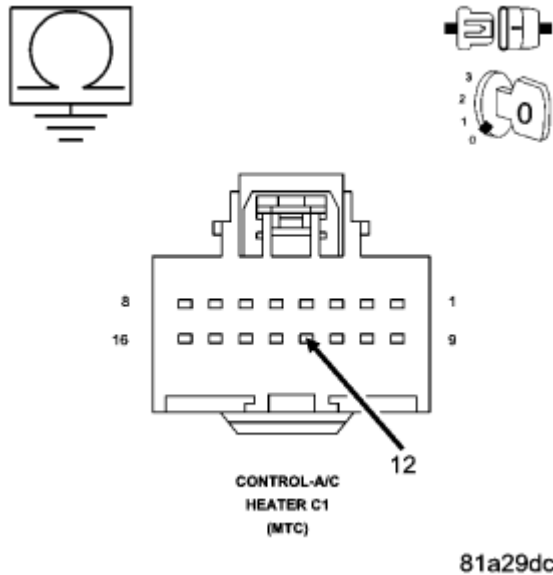

**Fig. 31: Measuring Resistance Between Ground And (C35) Mode Door Driver Circuit In A/C Heater Control C1 Harness Connector**  
 Courtesy of CHRYSLER LLC

Measure the resistance between ground and the (C35) Mode Door Driver circuit in the A/C Heater Control C1 harness connector.

**Does the ohm meter read open circuit?**

**Yes**

Go to 9).

**No**

Repair the (C35) Mode Door Driver circuit for a short to ground.

Perform **BODY VERIFICATION TEST - VER 1** .

**9) CHECK (C154) COMMON DOOR DRIVER CIRCUIT FOR A SHORT TO GROUND**



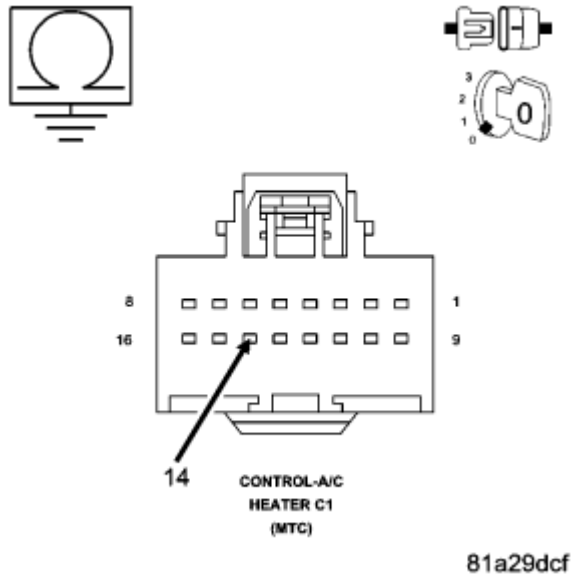

**Fig. 32: Measuring Resistance Between Ground And (C154) Common Door Driver Circuit In A/C Heater Control C1 Harness Connector**  
 Courtesy of CHRYSLER LLC

Measure the resistance between ground and the (C154) Common Door Driver circuit in the A/C Heater Control C1 harness connector.

**Does the ohm meter read open circuit?**

**Yes**

Go to 10).

**No**

Repair the (C154) Common Door Driver circuit for a short to ground.

Perform **BODY VERIFICATION TEST - VER 1** .

**10) CHECK RECIRCULATION DOOR ACTUATOR CIRCUIT RESISTANCE**

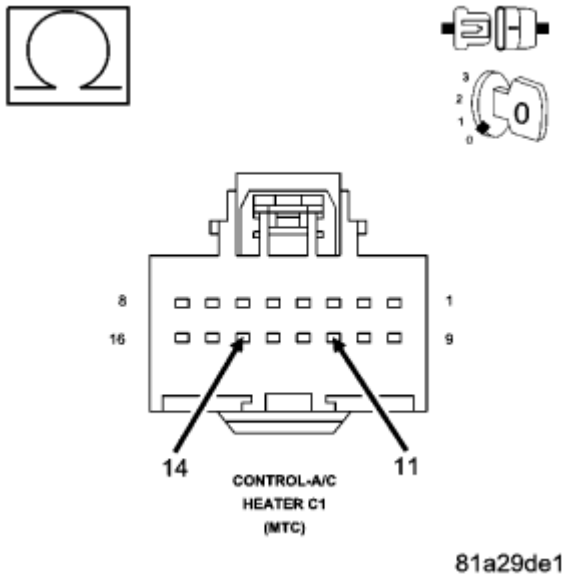

**Fig. 33: Measuring Resistance Between (C32) Recirculation Door Driver Circuit And (C154) Common Door Driver Circuit In A/C Heater Control C1 Harness Connector**  
 Courtesy of CHRYSLER LLC

Measure the resistance between the (C32) Recirculation Door Driver circuit and the (C154) Common Door Driver circuit in the A/C Heater Control C1 harness connector.

**Is the resistance between 30 and 40 ohms?**

**Yes**

Go to 11).

**No**

Replace the Recirculation Door Actuator in accordance with the service information.

Perform **BODY VERIFICATION TEST - VER 1** .

**11) CHECK MODE DOOR ACTUATOR CIRCUIT RESISTANCE**

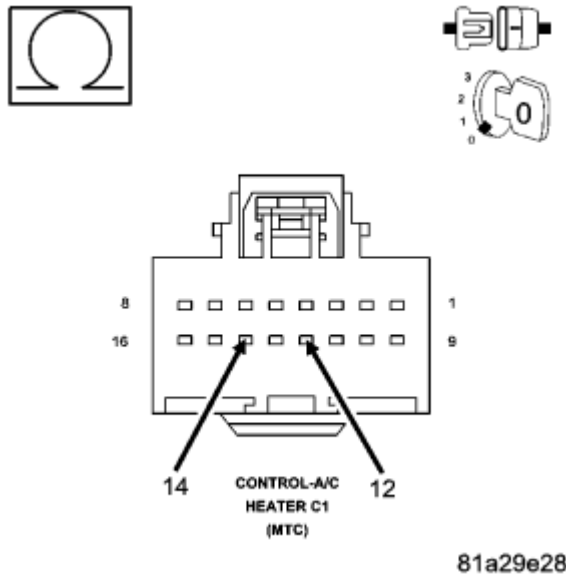

**Fig. 34: Measuring Resistance Between (C35) Mode Door Driver Circuit And (C154) Common Door Driver Circuit In A/C Heater Control C1 Harness Connector**  
Courtesy of CHRYSLER LLC

Measure the resistance between the (C35) Mode Door Driver circuit and the (C154) Common Door Driver circuit in the A/C Heater Control C1 harness connector.

**Is the resistance between 30 and 40 ohms?**

**Yes**

Go to 12).

**No**

Replace the Mode Door Actuator in accordance with the service information.

Perform **BODY VERIFICATION TEST - VER 1** .

**12) CHECK BLEND DOOR ACTUATOR CIRCUIT RESISTANCE**

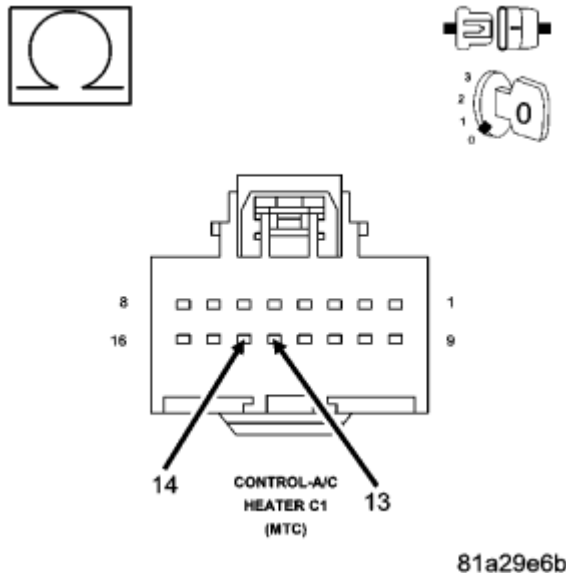

**Fig. 35: Measuring Resistance Between (C54) Blend Door Driver Circuit And (C154) Common Door Driver Circuit In A/C Heater Control C1 Harness Connector**  
 Courtesy of CHRYSLER LLC

Measure the resistance between the (C54) Blend Door Driver circuit and the (C154) Common Door Driver circuit in the A/C Heater Control C1 harness connector.

**Is the resistance between 30 and 40 ohms?**

**Yes**

Go to 13).

**No**

Replace the Blend Door Actuator in accordance with the service information.

Perform **BODY VERIFICATION TEST - VER 1** .

### **13) RUN THE ACTUATOR CALIBRATION TEST**

Reconnect the A/C Heater Control C1 harness connector.

Turn the ignition on.

With the scan tool, erase HVAC DTCs.

Turn the ignition off, wait 10 seconds, and then turn the ignition on.

With the scan tool, select System Tests and then select Actuator Calibration Test. When the test is complete, select View DTCs.

**Does the scan tool only display: B1058-RECIRCULATION DOOR CONTROL CIRCUIT/PERFORMANCE?**

**Yes**

Replace the A/C Heater Control in accordance with the service information.  
Perform **BODY VERIFICATION TEST - VER 1** .

**No, Other DTC(s) Displayed**

Diagnose and repair the other DTC(s). Refer to the **DIAGNOSTIC CODE INDEX** for a complete list of all HVAC related symptoms.

**No, And No Other DTCs Displayed**

Using the wiring diagram as a guide, inspect the wiring and connectors for conditions causing an intermittent short. Repair as necessary.  
Perform **BODY VERIFICATION TEST - VER 1** .

**B105B-RECIRCULATION DOOR CONTROL CIRCUIT OPEN (TIPM)**

For complete wiring diagrams refer to **SYSTEM WIRING DIAGRAMS** article.

**When Monitored:**

When actuator movement is requested.

**Set Condition:**

If the (C268) Recirculation Door Driver circuit or the (C68) Recirculation Door Common Driver circuit is open.

**Possible Causes**

(C268) RECIRCULATION DOOR DRIVER CIRCUIT OPEN  
(C68) RECIRCULATION DOOR COMMON DRIVER CIRCUIT OPEN  
RECIRCULATION DOOR ACTUATOR  
A/C HEATER CONTROL

**Diagnostic Test**

**1) CHECK FOR ACTIVE CONTROL CIRCUIT/PERFORMANCE DTCs**

Turn the ignition on.

With the scan tool, read active HVAC DTCs.

## 2007 Dodge Nitro R/T

2007 HVAC Heating & Air Conditioning - Electrical Diagnostics - Nitro

**Does the scan tool display any active: XXXX CONTROL CIRCUIT/PERFORMANCE DTCs?**

**Yes**

Diagnose and repair the DTC(s). Refer to the **DIAGNOSTIC CODE INDEX** for a complete list of all HVAC related symptoms.

**No**

Go to 2).

### **2) CHECK THE RECIRCULATION DOOR ACTUATOR CIRCUIT RESISTANCE**

Turn the ignition off.

Disconnect the A/C Heater Control C2 harness connector.

Measure the resistance between the (C268) Recirculation Door Driver circuit and the (C68) Recirculation Door Common Driver circuit in the A/C Heater Control C2 harness connector.

**Is the resistance above 70.0 ohms?**

**Yes**

Go to 3).

**No**

Replace the A/C Heater Control in accordance with the Service Information.

Perform **BODY VERIFICATION TEST - VER 1** .

### **3) CHECK THE (C268) RECIRCULATION DOOR DRIVER CIRCUIT FOR AN OPEN**

Disconnect the Recirculation Door Actuator harness connector.

Measure the resistance of the (C268) Recirculation Door Driver circuit between the Recirculation Door Actuator harness connector and the A/C Heater Control C2 harness connector.

**Is the resistance below 5.0 ohms?**

**Yes**

Go to 4).

**No**

Repair the (C268) Recirculation Door Driver circuit for an open.

Perform **BODY VERIFICATION TEST - VER 1** .

## 2007 Dodge Nitro R/T

2007 HVAC Heating & Air Conditioning - Electrical Diagnostics - Nitro

### 4) CHECK THE (C68) RECIRCULATION DOOR COMMON DRIVER CIRCUIT FOR AN OPEN

Measure the resistance of the (C68) Recirculation Door Common Driver circuit between the Recirculation Door Actuator harness connector and the A/C Heater Control C2 harness connector.

**Is the resistance below 5.0 ohms?**

**Yes**

Replace the Recirculation Door Actuator in accordance with the Service Information.

Perform **BODY VERIFICATION TEST - VER 1** .

**No**

Repair the (C68) Recirculation Door Common Driver circuit for an open.

Perform **BODY VERIFICATION TEST - VER 1** .

**B105B-RECIRCULATION DOOR CONTROL CIRCUIT OPEN**

# 2007 Dodge Nitro R/T

## 2007 HVAC Heating & Air Conditioning - Electrical Diagnostics - Nitro

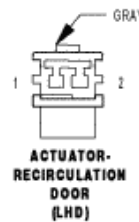
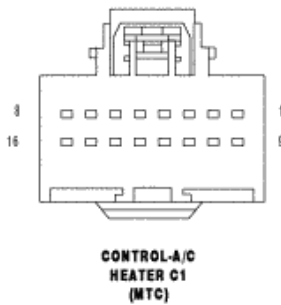
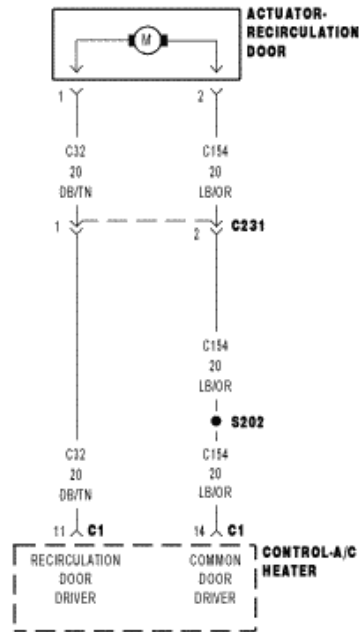

8106600

**Fig. 36: Recirculation Door Control Circuit Schematic**  
 Courtesy of CHRYSLER LLC

For complete wiring diagrams refer to **SYSTEM WIRING DIAGRAMS** article.

The A/C Heater Control drives the Recirculation Door Actuator via the (C32) Recirculation Door Driver circuit



## 2007 Dodge Nitro R/T

2007 HVAC Heating & Air Conditioning - Electrical Diagnostics - Nitro

and the (C154) Common Door Driver 2 circuit.

### When Monitored:

With the ignition on.

### Set Condition:

If the Recirculation Door Actuator's electrical circuit is open.

### Possible Causes

(C32) RECIRCULATION DOOR DRIVER CIRCUIT OPEN  
(C154) COMMON DOOR DRIVER 2 CIRCUIT OPEN  
RECIRCULATION DOOR ACTUATOR  
A/C HEATER CONTROL

### Diagnostic Test

#### 1) ACTIVE DTC(S) PRESENT

Turn the ignition on.

Using the A/C Heater Control, actuate the Recirculation Door.

With the scan tool, check for DTCs.

**Does the scan tool display this DTC as active?**

**Yes**

Go to 2).

**No**

The condition that caused this symptom is currently not present. Check for an intermittent condition by inspecting the related wiring harness for chafed, pierced, pinched, and partially broken wires. Also, inspect the related connectors for broken, bent, pushed out, spread, corroded, or contaminated terminals. Repair as necessary.

Perform **BODY VERIFICATION TEST - VER 1** .

#### 2) CHECK (C32) RECIRCULATION DOOR DRIVER CIRCUIT FOR AN OPEN

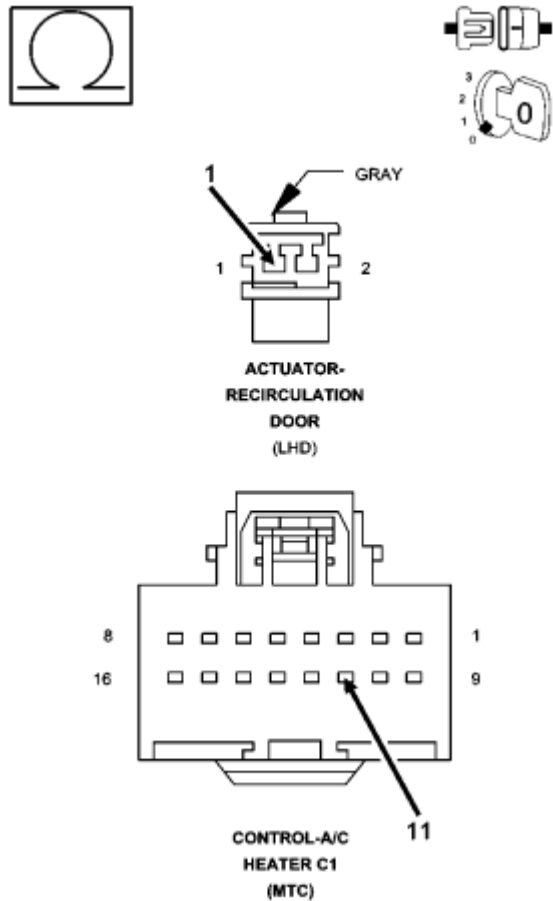

819faafa

**Fig. 37: Measuring Resistance Of (C32) Recirculation Door Driver Circuit Between A/C Heater Control C1 Harness Connector And Recirculation Door Actuator Harness Connector**  
 Courtesy of CHRYSLER LLC

Turn the ignition off.

Disconnect the A/C Heater Control C1 harness connector.

Disconnect the Recirculation Door Actuator harness connector.

Measure the resistance of the (C32) Recirculation Door Driver circuit between the A/C Heater Control C1 harness connector and the Recirculation Door Actuator harness connector.

**Does the ohm meter read open circuit?**

**Yes**

Repair the (C32) Recirculation Door Driver circuit for an open.

Perform **BODY VERIFICATION TEST - VER 1** .

No

Go to 3).

**3) CHECK (C154) COMMON DOOR DRIVER 2 CIRCUIT FOR AN OPEN**

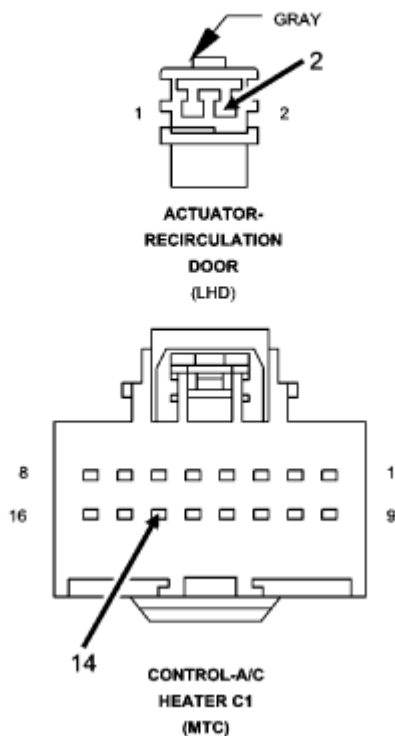

819fab04

**Fig. 38: Measuring Resistance Of (C154) Common Door Driver 2 Circuit Between A/C Heater Control C1 Harness Connector And Recirculation Door Actuator Harness Connector**  
 Courtesy of CHRYSLER LLC

Measure the resistance of the (C154) Common Door Driver 2 circuit between the A/C Heater Control C1 harness connector and the Recirculation Door Actuator harness connector.

**Does the ohm meter read open circuit?**

Yes

Repair the (C154) Common Door Driver 2 circuit for an open.

Perform **BODY VERIFICATION TEST - VER 1** .

No

Go to 4).

#### 4) CHECK RECIRCULATION DOOR ACTUATOR CIRCUIT RESISTANCE

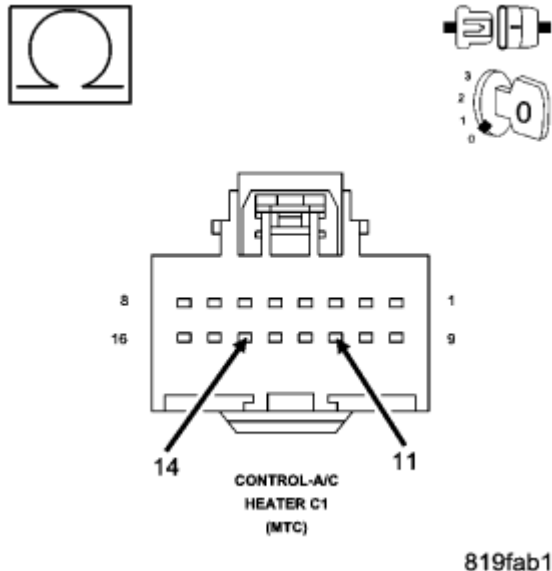

**Fig. 39: Measuring Resistance Between (C32) Recirculation Door Driver Circuit And (C154) Common Door Driver 2 Circuit In A/C Heater Control C1 Harness Connector**  
 Courtesy of CHRYSLER LLC

Reconnect the Recirculation Door Actuator harness connector.

Measure the resistance between the (C32) Recirculation Door Driver circuit and the (C154) Common Door Driver 2 circuit in the A/C Heater Control C1 harness connector.

**Is the resistance between 30 and 40 ohms?**

Yes

Replace the Recirculation Door Actuator in accordance with the service information.  
 Perform **BODY VERIFICATION TEST - VER 1** .

No

Replace the A/C Heater Control in accordance with the service information.  
 Perform **BODY VERIFICATION TEST - VER 1** .

#### **B105C-RECIRCULATION DOOR TRAVEL RANGE TOO SMALL**

For complete wiring diagrams refer to **SYSTEM WIRING DIAGRAMS** article.

## 2007 Dodge Nitro R/T

2007 HVAC Heating & Air Conditioning - Electrical Diagnostics - Nitro

The A/C Heater Control calibrates each actuator individually. Automatic calibration occurs upon power up after installing a new A/C Heater Control. Manual calibration occurs by sending a command with the scan tool. The purpose of actuator calibration is to determine the total span of door travel between physical stops. To calibrate the actuator, the A/C Heater Control first moves the door to its soft stop, and then counts the number of pulses it takes to move the door to its other stop. An expected range of span is stored in the control's memory. If the measured calibration value is less than the expected range for this actuator, this DTC will set. Note that the control clears all stored calibration faults at the beginning of the calibration procedure.

### When Monitored:

During actuator calibration.

### Set Condition:

If the total span of the Recirculation Door is less than the low range limit.

### Possible Causes

DOOR DRIVER ELECTRICAL CIRCUIT(S)  
RECIRCULATION DOOR SEIZED, BINDING, OBSTRUCTED  
RECIRCULATION DOOR ACTUATOR  
A/C HEATER CONTROL

### Diagnostic Test

#### 1) CHECK FOR ACTIVE CONTROL CIRCUIT/PERFORMANCE & CONTROL CIRCUIT OPEN DTCs

Turn the ignition on.

With the scan tool, read active HVAC DTCs.

#### Does the scan tool display any active CONTROL CIRCUIT/PERFORMANCE or CONTROL CIRCUIT OPEN DTCs?

**Yes**

Diagnose and repair the DTC(s). If present, diagnose and repair all Rear Blend and Rear Mode Door Control Circuit/Performance DTCs first, all other Control Circuit/Performance DTCs second, and all Control Circuit Open DTCs last. Refer to the **DIAGNOSTIC CODE INDEX** for a complete list of all HVAC related symptoms.

**No**

Go to 2).

#### 2) INSPECT ACTUATOR & HOUSING ASSEMBLY FOR A CONDITION CAUSING THE DOOR TO SEIZE OR BIND

Turn the ignition off.

Inspect the actuator and the housing assembly for a condition causing the door to seize or bind.

**Are there any physical or mechanical problems with the door, housing, or actuator?**

**Yes**

Repair as necessary in accordance with the service information.

Perform **BODY VERIFICATION TEST - VER 1** .

**No**

Go to 3).

### **3) CHECK RECIRCULATION DOOR TRAVEL**

Remove the Recirculation Door Actuator from the A/C Heater Housing Assembly.

By hand, attempt to rotate the door in both directions. The door should operate smoothly in both directions over approximately 70 degrees of travel.

**Does the door operate smoothly in both directions over approximately 70 degrees of travel?**

**Yes**

Replace the Recirculation Door Actuator in accordance with the service information. Then, go to 4).

**No**

Repair as necessary in accordance with the service information.

Perform **BODY VERIFICATION TEST - VER 1** .

### **4) RUN THE ACTUATOR CALIBRATION TEST**

Turn the ignition on.

With the scan tool, select System Tests and then select Actuator Calibration Test. When the test is complete, select View DTCs.

**Does the scan tool display this DTC as active?**

**Yes**

Replace the A/C Heater Control in accordance with the service information.

Perform **BODY VERIFICATION TEST - VER 1** .

**No**

Perform **BODY VERIFICATION TEST - VER 1** .

**B105D-RECIRCULATION DOOR TRAVEL RANGE TOO LARGE**

For complete wiring diagrams refer to **SYSTEM WIRING DIAGRAMS** article.

The A/C Heater Control calibrates each actuator individually. Automatic calibration occurs upon power up after installing a new A/C Heater Control. Manual calibration occurs by sending a command with the scan tool. The purpose of actuator calibration is to determine the total span of door travel between physical stops. To calibrate the actuator, the A/C Heater Control first moves the door to its soft stop, and then counts the number of pulses it takes to move the door to its other stop. An expected range of span is stored in the control's memory. If the measured calibration value exceeds the expected range for this actuator, this DTC will set. Note that the control clears all stored calibration faults at the beginning of the calibration procedure.

**When Monitored:**

During actuator calibration.

**Set Condition:**

If the total span of the Recirculation Door exceeds the high range limit.

Possible Causes
DOOR DRIVER ELECTRICAL CIRCUIT(S) RECIRCULATION DOOR OR A/C HEATER HOUSING COMPONENTS WARPED, WORN, DAMAGED, MISSING, BROKEN RECIRCULATION DOOR ACTUATOR A/C HEATER CONTROL

**Diagnostic Test****1) CHECK FOR ACTIVE CONTROL CIRCUIT/PERFORMANCE & CONTROL CIRCUIT OPEN DTCs**

Turn the ignition on.

With the scan tool, read active HVAC DTCs.

**Does the scan tool display any active CONTROL CIRCUIT/PERFORMANCE or CONTROL CIRCUIT OPEN DTCs?**

**Yes**

Diagnose and repair the DTC(s). If present, diagnose and repair all Rear Blend and Rear Mode

Door Control Circuit/Performance DTCs first, all other Control Circuit/Performance DTCs second, and all Control Circuit Open DTCs last. Refer to the **DIAGNOSTIC CODE INDEX** for a complete list of all HVAC related symptoms.

**No**

Go to 2).

**2) CHECK FOR A BROKEN RECIRCULATION DOOR ACTUATOR**

Turn the ignition off.

Remove the Recirculation Door Actuator from the A/C Heater Housing Assembly.

By hand, attempt to rotate the actuator in both directions.

**Does the actuator turn in either direction?**

**Yes**

Replace the Recirculation Door Actuator in accordance with the service information.

Perform **BODY VERIFICATION TEST - VER 1** .

**No**

Go to 3).

**3) CHECK RECIRCULATION DOOR & A/C HEATER HOUSING FOR WARPED, WORN, DAMAGED, MISSING, & BROKEN COMPONENTS**

Inspect for a damaged or broken A/C Heater Housing Assembly, a warped, worn, or broken door, and missing door seals. Rotate the door from stop to stop. The door should rotate approximately 70 degrees.

**Are there any physical or mechanical problems with the door or housing?**

**Yes**

Repair as necessary in accordance with the service information.

Perform **BODY VERIFICATION TEST - VER 1** .

**No**

Replace the Recirculation Door Actuator in accordance with the service information. Then, go to 4).

**4) RUN THE ACTUATOR CALIBRATION TEST**

Turn the ignition on.



## 2007 Dodge Nitro R/T

2007 HVAC Heating & Air Conditioning - Electrical Diagnostics - Nitro

With the scan tool, select System Tests and then select Actuator Calibration Test. When the test is complete, select View DTCs.

**Does the scan tool display this DTC as active?**

**Yes**

Replace the A/C Heater Control in accordance with the service information.

Perform **BODY VERIFICATION TEST - VER 1** .

**No**

Perform **BODY VERIFICATION TEST - VER 1** .

**B10A2-LEFT BLEND DOOR CONTROL CIRCUIT/PERFORMANCE**

# 2007 Dodge Nitro R/T

## 2007 HVAC Heating & Air Conditioning - Electrical Diagnostics - Nitro

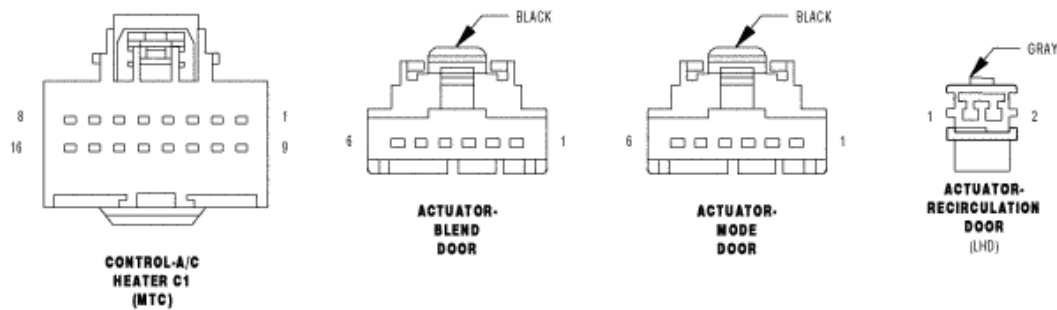
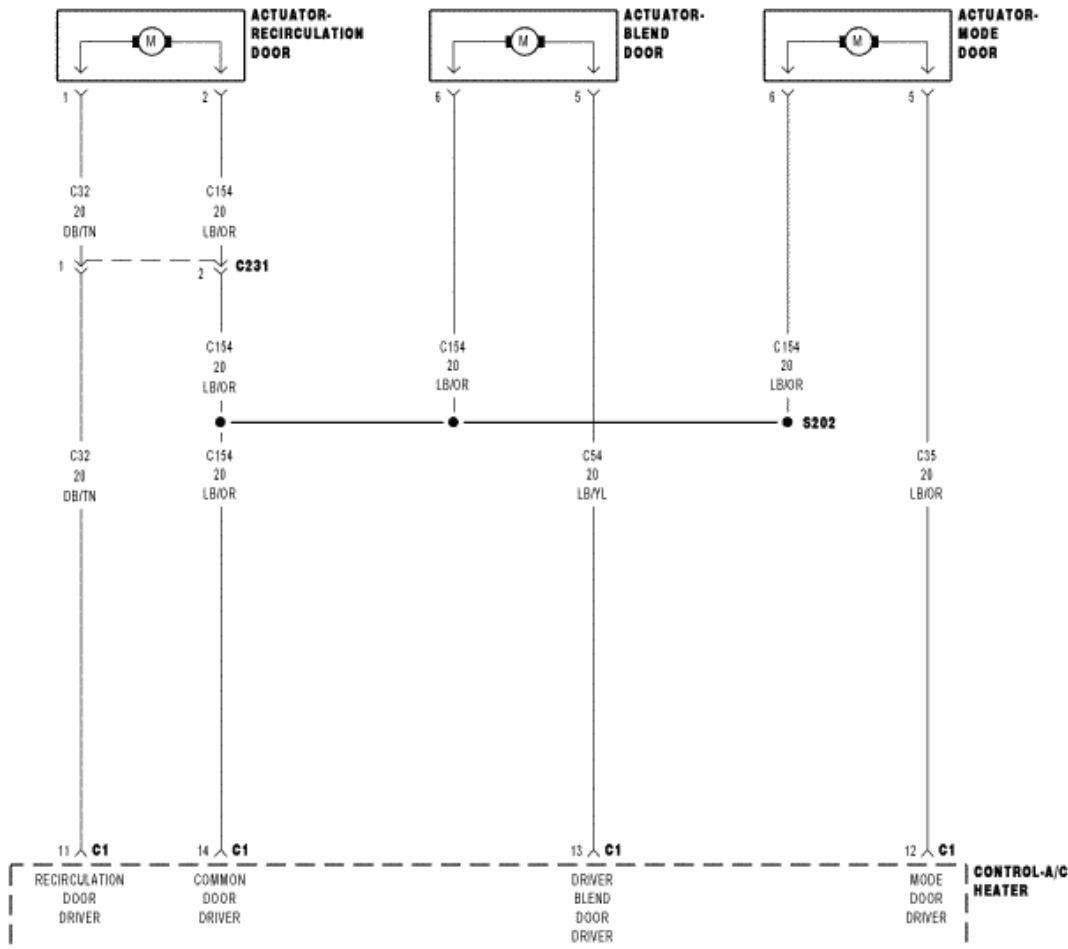

01a25602

**Fig. 40: Blend Door Control Circuit Schematic**  
 Courtesy of CHRYSLER LLC

For complete wiring diagrams refer to **SYSTEM WIRING DIAGRAMS** article.

The A/C Heater Control monitors the door driver circuits during actuator operation for shorts to ground, shorts

## 2007 Dodge Nitro R/T

2007 HVAC Heating & Air Conditioning - Electrical Diagnostics - Nitro

to battery, and shorts to other door driver circuits. If detected, the A/C Heater Control reports these types of faults as Control Circuit/Performance DTCs.

### When Monitored:

With the ignition on.

### Set Condition:

If the A/C Heater Control detects a short to ground or to voltage on the (C32) Recirculation Door Driver, the (C35) Mode Door Driver, or the (C154) Common Door Driver circuits while attempting to drive the (C54) Blend Door Driver.

### Possible Causes

(C32) RECIRCULATION DOOR DRIVER CIRCUIT SHORTED TO VOLTAGE  
(C54) BLEND DOOR DRIVER CIRCUIT SHORTED TO VOLTAGE  
(C35) MODE DOOR DRIVER CIRCUIT SHORTED TO VOLTAGE  
(C154) COMMON DOOR DRIVER CIRCUIT SHORTED TO VOLTAGE  
(C32) RECIRCULATION DOOR DRIVER CIRCUIT SHORTED TO GROUND  
(C54) BLEND DOOR DRIVER CIRCUIT SHORTED TO GROUND  
(C35) MODE DOOR DRIVER CIRCUIT SHORTED TO GROUND  
(C154) COMMON DOOR DRIVER CIRCUIT SHORTED TO GROUND  
RECIRCULATION DOOR ACTUATOR  
MODE DOOR ACTUATOR  
BLEND DOOR ACTUATOR  
A/C HEATER CONTROL

### Diagnostic Test

#### 1) ACTIVE DTC(S) PRESENT

Turn the ignition on.

Using the A/C Heater Control, actuate the Blend Door.

With the scan tool, check for DTCs.

**Does the scan tool display this DTC as active?**

**Yes**

Go to 2).

**No**

The condition that caused this symptom is currently not present. Check for an intermittent condition by inspecting the related wiring harness for chafed, pierced, pinched, and partially broken wires. Also, inspect the related connectors for broken, bent, pushed out, spread, corroded, or contaminated terminals. Repair as necessary.

Perform **BODY VERIFICATION TEST - VER 1** .

## 2) CHECK (C32) RECIRCULATION DOOR DRIVER CIRCUIT FOR A SHORT TO VOLTAGE

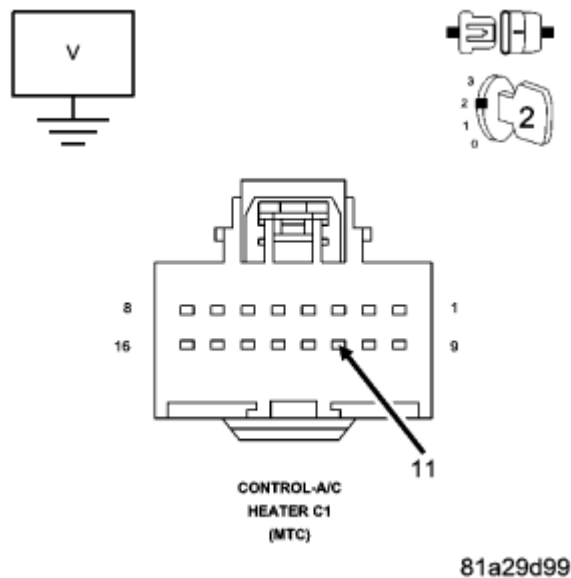

**Fig. 41: Measuring Voltage Of (C32) Recirculation Door Driver Circuit In A/C Heater Control C1 Harness Connector**

Courtesy of CHRYSLER LLC

Turn the ignition off.

Disconnect the A/C Heater Control C1 harness connector.

Turn the ignition on.

Measure the voltage of the (C32) Recirculation Door Driver circuit in the A/C Heater Control C1 harness connector.

**Is there any voltage present?**

**Yes**

Repair the (C32) Recirculation Door Driver circuit for a short to voltage.

Perform **BODY VERIFICATION TEST - VER 1** .

**No**

Go to 3).

### 3) CHECK (C35) MODE DOOR DRIVER CIRCUIT FOR A SHORT TO VOLTAGE

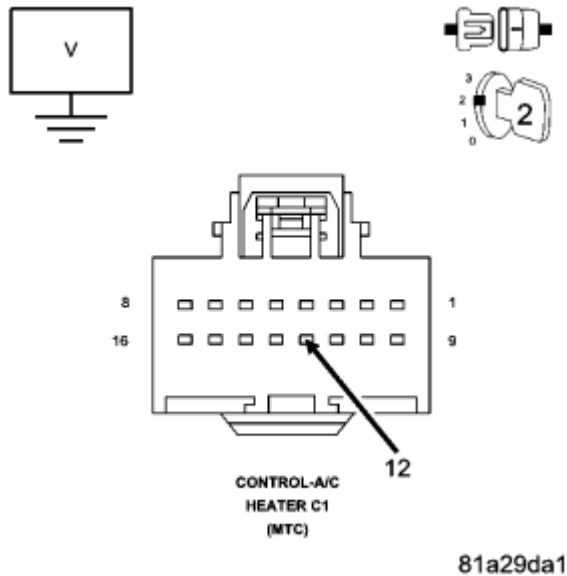

**Fig. 42: Measuring Voltage Of (C35) Mode Door Driver Circuit In A/C Heater Control C1 Harness Connector**

Courtesy of CHRYSLER LLC

Measure the voltage of the (C35) Mode Door Driver circuit in the A/C Heater Control C1 harness connector.

**Is there any voltage present?**

**Yes**

Repair the (C35) Mode Door Driver circuit for a short to voltage.

Perform **BODY VERIFICATION TEST - VER 1** .

**No**

Go to 4).

### 4) CHECK (C54) BLEND DOOR DRIVER CIRCUIT FOR A SHORT TO VOLTAGE

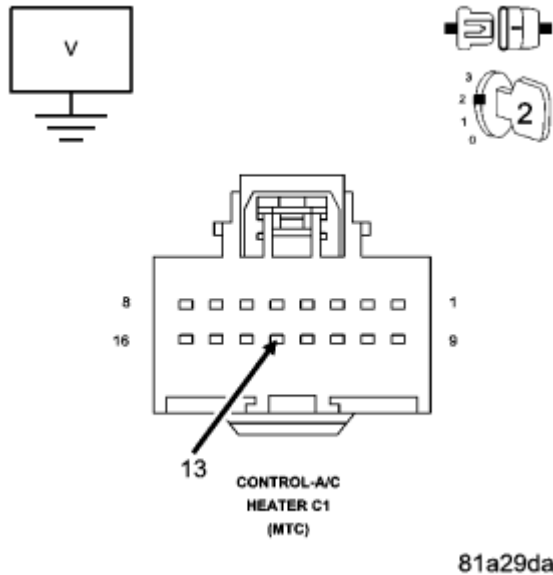

**Fig. 43: Measuring Voltage Of (C54) Blend Door Driver Circuit In A/C Heater Control C1 Harness Connector**

Courtesy of CHRYSLER LLC

Measure the voltage of the (C54) Blend Door Driver circuit in the A/C Heater Control C1 harness connector.

**Is there any voltage present?**

**Yes**

Repair the (C54) Blend Door Driver circuit for a short to voltage.

Perform **BODY VERIFICATION TEST - VER 1** .

**No**

Go to 5).

**5) CHECK (C154) COMMON DOOR DRIVER CIRCUIT FOR A SHORT TO VOLTAGE**

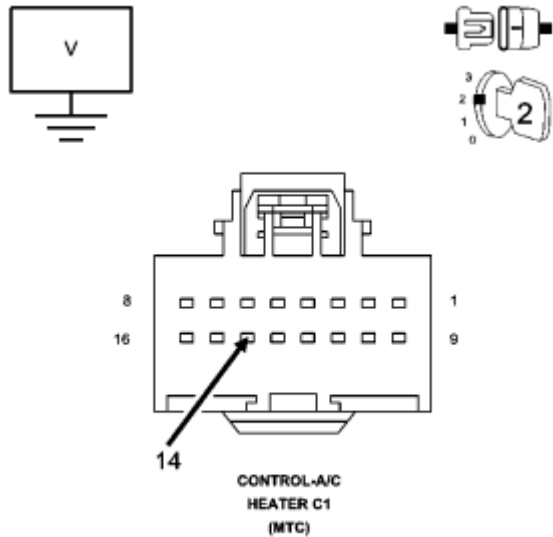

81a29dac

**Fig. 44: Measuring Voltage Of (C154) Common Door Driver Circuit In A/C Heater Control C1 Harness Connector**

Courtesy of CHRYSLER LLC

Measure the voltage of the (C154) Common Door Driver circuit in the A/C Heater Control C1 harness connector.

**Is there any voltage present?**

**Yes**

Repair the (C154) Common Door Driver circuit for a short to voltage.

Perform **BODY VERIFICATION TEST - VER 1** .

**No**

Go to 6).

**6) CHECK (C32) RECIRCULATION DOOR DRIVER CIRCUIT FOR A SHORT TO GROUND**

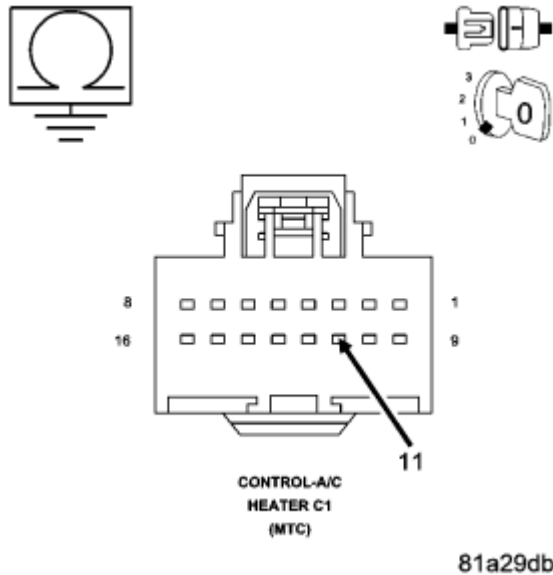

**Fig. 45: Measuring Resistance Between Ground And (C32) Recirculation Door Driver Circuit In A/C Heater Control C1 Harness Connector**  
Courtesy of CHRYSLER LLC

Turn the ignition off.

Measure the resistance between ground and the (C32) Recirculation Door Driver circuit in the A/C Heater Control C1 harness connector.

**Does the ohm meter read open circuit?**

**Yes**

Go to 7).

**No**

Repair the (C32) Recirculation Door Driver circuit for a short to ground.

Perform **BODY VERIFICATION TEST - VER 1** .

**7) CHECK (C54) DRIVER BLEND DOOR DRIVER CIRCUIT FOR A SHORT TO GROUND**



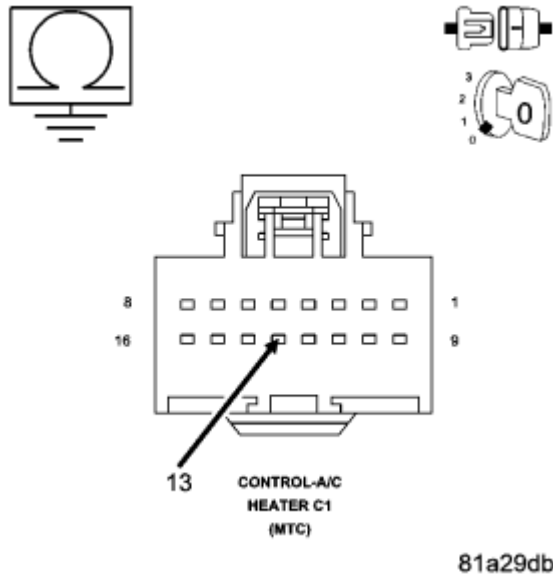

**Fig. 46: Measuring Resistance Between Ground And (C54) Driver Blend Door Driver Circuit In A/C Heater Control C1 Harness Connector**  
 Courtesy of CHRYSLER LLC

Measure the resistance between ground and the (C54) Driver Blend Door Driver circuit in the A/C Heater Control C1 harness connector.

**Does the ohm meter read open circuit?**

**Yes**

Go to 8).

**No**

Repair the (C54) Driver Blend Door Driver circuit for a short to ground.

Perform **BODY VERIFICATION TEST - VER 1** .

**8) CHECK (C35) MODE DOOR DRIVER CIRCUIT FOR A SHORT TO GROUND**

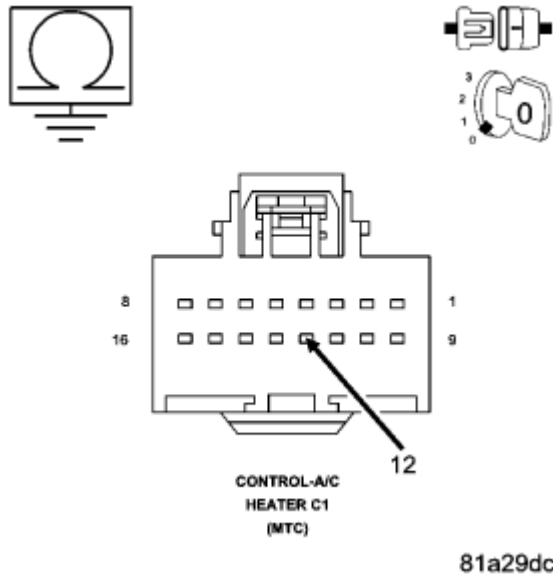

**Fig. 47: Measuring Resistance Between Ground And (C35) Mode Door Driver Circuit In A/C Heater Control C1 Harness Connector**  
 Courtesy of CHRYSLER LLC

Measure the resistance between ground and the (C35) Mode Door Driver circuit in the A/C Heater Control C1 harness connector.

**Does the ohm meter read open circuit?**

**Yes**

Go to 9).

**No**

Repair the (C35) Mode Door Driver circuit for a short to ground.

Perform **BODY VERIFICATION TEST - VER 1** .

**9) CHECK (C154) COMMON DOOR DRIVER CIRCUIT FOR A SHORT TO GROUND**

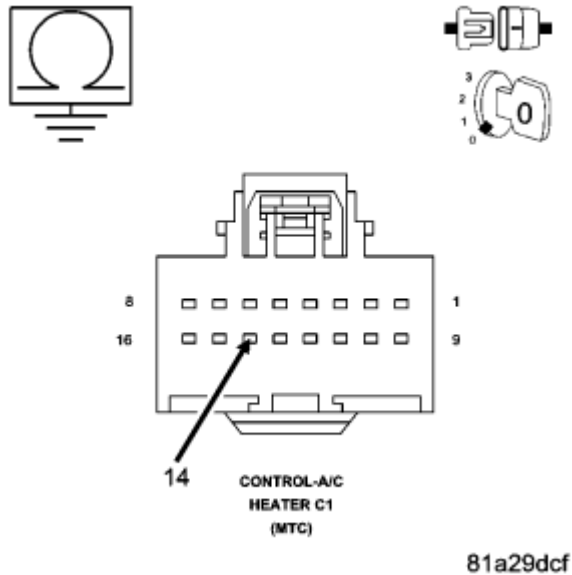

**Fig. 48: Measuring Resistance Between Ground And (C154) Common Door Driver Circuit In A/C Heater Control C1 Harness Connector**  
 Courtesy of CHRYSLER LLC

Measure the resistance between ground and the (C154) Common Door Driver circuit in the A/C Heater Control C1 harness connector.

**Does the ohm meter read open circuit?**

**Yes**

Go to 10).

**No**

Repair the (C154) Common Door Driver circuit for a short to ground.

Perform **BODY VERIFICATION TEST - VER 1** .

**10) CHECK RECIRCULATION DOOR ACTUATOR CIRCUIT RESISTANCE**

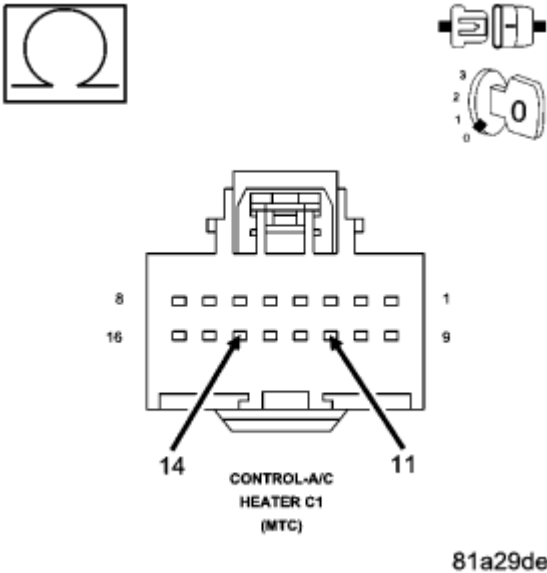

**Fig. 49: Measuring Resistance Between (C32) Recirculation Door Driver Circuit And (C154) Common Door Driver Circuit In A/C Heater Control C1 Harness Connector**  
 Courtesy of CHRYSLER LLC

Measure the resistance between the (C32) Recirculation Door Driver circuit and the (C154) Common Door Driver circuit in the A/C Heater Control C1 harness connector.

**Is the resistance between 30 and 40 ohms?**

**Yes**

Go to 11).

**No**

Replace the Recirculation Door Actuator in accordance with the service information.

Perform **BODY VERIFICATION TEST - VER 1** .

**11) CHECK MODE DOOR ACTUATOR CIRCUIT RESISTANCE**

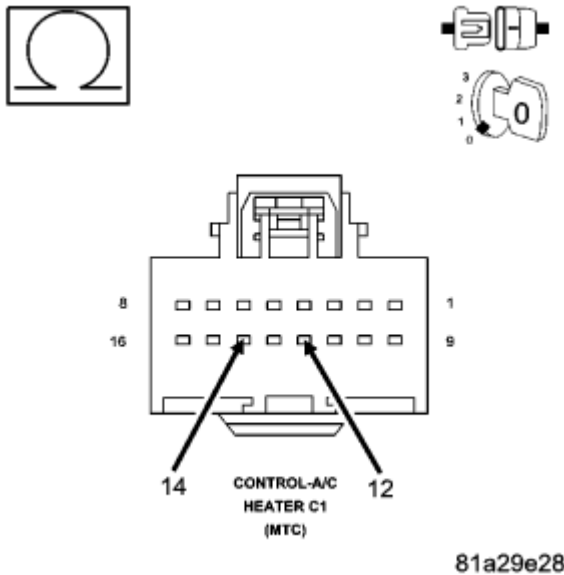

**Fig. 50: Measuring Resistance Between (C35) Mode Door Driver Circuit And (C154) Common Door Driver Circuit In A/C Heater Control C1 Harness Connector**  
 Courtesy of CHRYSLER LLC

Measure the resistance between the (C35) Mode Door Driver circuit and the (C154) Common Door Driver circuit in the A/C Heater Control C1 harness connector.

**Is the resistance between 30 and 40 ohms?**

**Yes**

Go to 12).

**No**

Replace the Mode Door Actuator in accordance with the service information.

Perform **BODY VERIFICATION TEST - VER 1** .

**12) CHECK BLEND DOOR ACTUATOR CIRCUIT RESISTANCE**

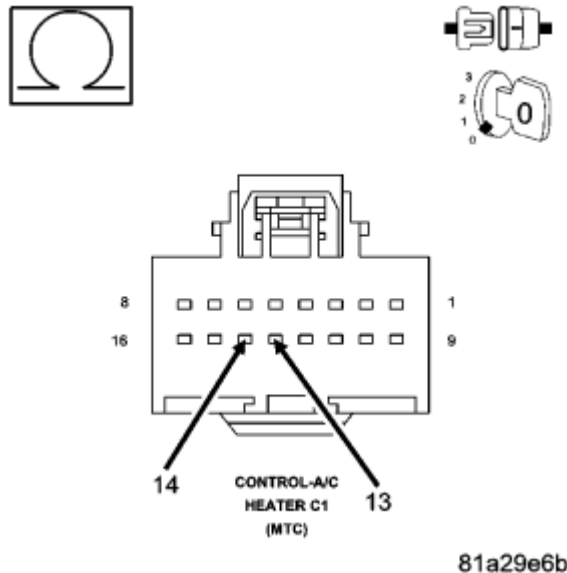

**Fig. 51: Measuring Resistance Between (C54) Blend Door Driver Circuit And (C154) Common Door Driver Circuit In A/C Heater Control C1 Harness Connector**  
 Courtesy of CHRYSLER LLC

Measure the resistance between the (C54) Blend Door Driver circuit and the (C154) Common Door Driver circuit in the A/C Heater Control C1 harness connector.

**Is the resistance between 30 and 40 ohms?**

**Yes**

Go to 13).

**No**

Replace the Blend Door Actuator in accordance with the service information.

Perform **BODY VERIFICATION TEST - VER 1**.

**13) RUN THE ACTUATOR CALIBRATION TEST**

Reconnect the A/C Heater Control C1 harness connector.

Turn the ignition on.

With the scan tool, erase HVAC DTCs.

Turn the ignition off, wait 10 seconds, and then turn the ignition on.

With the scan tool, select System Tests and then select Actuator Calibration Test. When the test is complete, select View DTCs.

**Does the scan tool only display: B10A2-LEFT BLEND DOOR CONTROL CIRCUIT/PERFORMANCE?**

**Yes**

Replace the A/C Heater Control in accordance with the service information.  
Perform **BODY VERIFICATION TEST - VER 1** .

**No, Other DTC(s) Displayed**

Diagnose and repair the other DTC(s). Refer to the **DIAGNOSTIC CODE INDEX** for a complete list of all HVAC related symptoms.

**No, And No Other DTCs Displayed**

Using the wiring diagram as a guide, inspect the wiring and connectors for conditions causing an intermittent short. Repair as necessary.  
Perform **BODY VERIFICATION TEST - VER 1** .

**B10A5-LEFT BLEND DOOR CONTROL CIRCUIT OPEN**

# 2007 Dodge Nitro R/T

## 2007 HVAC Heating & Air Conditioning - Electrical Diagnostics - Nitro

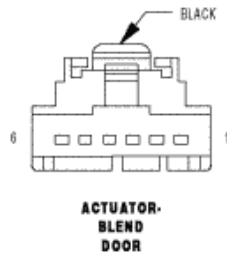
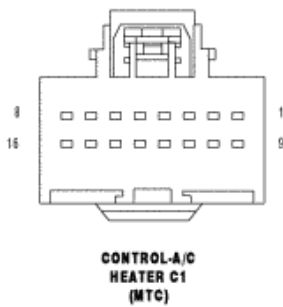
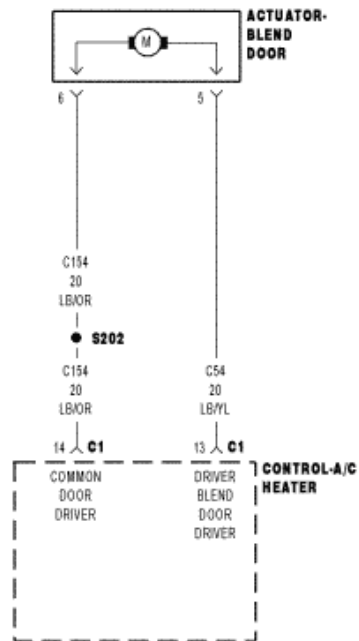

819745a

**Fig. 52: Blend Door Control Circuit Schematic**  
Courtesy of CHRYSLER LLC

For complete wiring diagrams refer to **SYSTEM WIRING DIAGRAMS** article.

The A/C Heater Control drives the Left Blend Door Actuator via the (C54) Left Blend Door Driver circuit and



## 2007 Dodge Nitro R/T

2007 HVAC Heating & Air Conditioning - Electrical Diagnostics - Nitro

the (C154) Common Door Driver circuit.

### When Monitored:

With the ignition on.

### Set Condition:

If the Left Blend Door Actuator's electrical circuit is open.

### Possible Causes

(C54) DRIVER BLEND DOOR DRIVER CIRCUIT OPEN  
(C154) COMMON DOOR DRIVER CIRCUIT OPEN  
LEFT BLEND DOOR ACTUATOR  
A/C HEATER CONTROL

### Diagnostic Test

#### 1) ACTIVE DTC(S) PRESENT

Turn the ignition on.

Using the A/C Heater Control, actuate the Left Blend Door.

With the scan tool, check for DTCs.

**Does the scan tool display this DTC as active?**

**Yes**

Go to 2).

**No**

The condition that caused this symptom is currently not present. Check for an intermittent condition by inspecting the related wiring harness for chafed, pierced, pinched, and partially broken wires. Also, inspect the related connectors for broken, bent, pushed out, spread, corroded, or contaminated terminals. Repair as necessary.

Perform **BODY VERIFICATION TEST - VER 1** .

#### 2) CHECK (C154) COMMON DOOR DRIVER CIRCUIT FOR AN OPEN

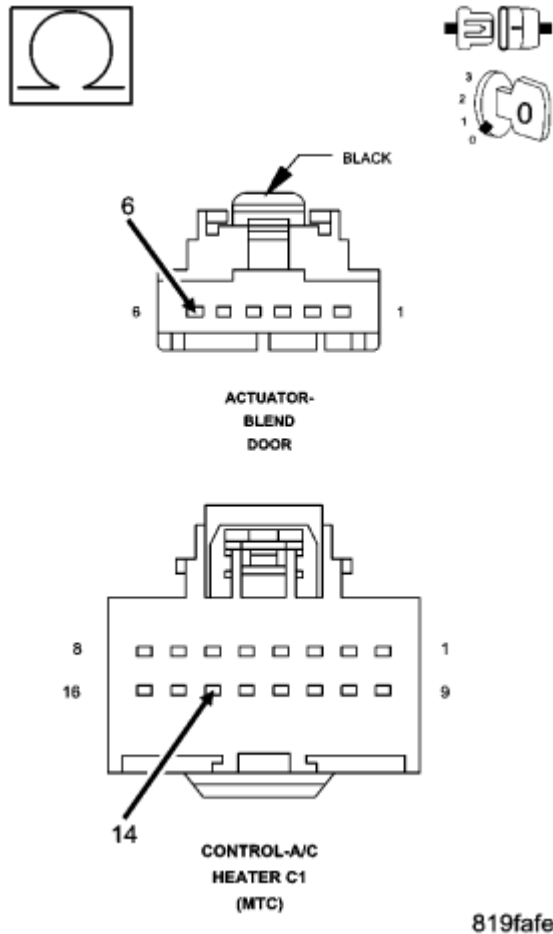

**Fig. 53: Measuring Resistance Of (C154) Common Door Driver Circuit Between A/C Heater Control C1 Harness Connector And Left Blend Door Actuator Harness Connector**  
 Courtesy of CHRYSLER LLC

Turn the ignition off.

Disconnect the A/C Heater Control C1 harness connector.

Disconnect the Left Blend Door Actuator harness connector.

Measure the resistance of the (C154) Common Door Driver circuit between the A/C Heater Control C1 harness connector and the Left Blend Door Actuator harness connector.

**Does the ohm meter read open circuit?**

**Yes**

Repair the (C154) Common Door Driver circuit for an open.

Perform **BODY VERIFICATION TEST - VER 1** .

No

Go to 3).

**3) CHECK (C54) LEFT BLEND DOOR DRIVER CIRCUIT FOR AN OPEN**

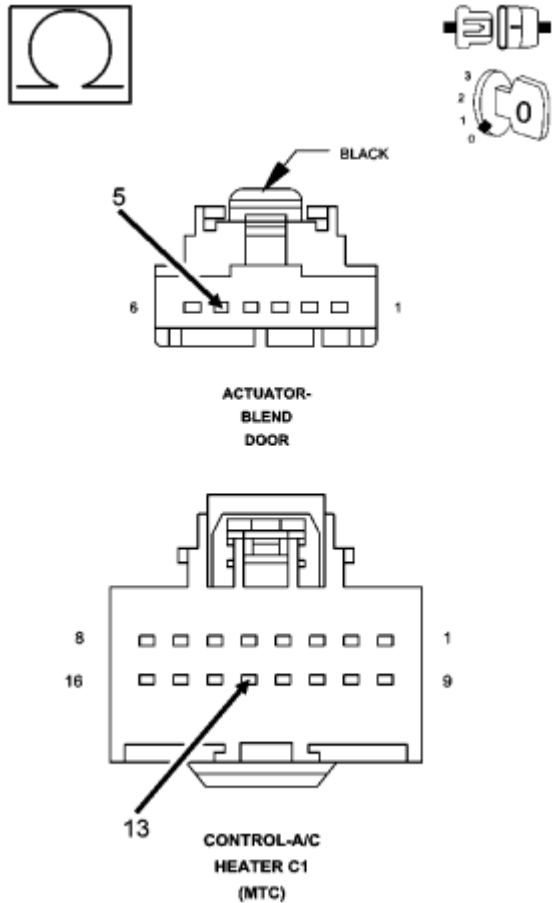

819fb017

**Fig. 54: Measuring Resistance Of (C54) Driver Blend Door Driver Circuit Between A/C Heater Control C1 Way Harness Connector And Left Blend Door Actuator Harness Connector**  
 Courtesy of CHRYSLER LLC

Measure the resistance of the (C54) Driver Blend Door Driver circuit between the A/C Heater Control C1 way harness connector and the Left Blend Door Actuator harness connector.

**Does the ohm meter read open circuit?**

Yes

Repair the (C54) Driver Blend Door Driver circuit for an open.

Perform **BODY VERIFICATION TEST - VER 1** .

No

Go to 4).

#### 4) CHECK LEFT BLEND DOOR ACTUATOR CIRCUIT RESISTANCE

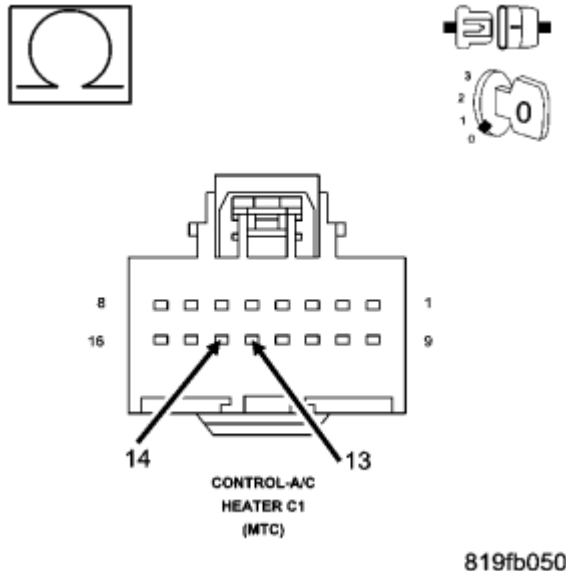

**Fig. 55: Measuring Resistance Between (C54) Driver Blend Door Driver Circuit And (C154) Common Door Driver Circuit In A/C Heater Control C1 Harness Connector**  
 Courtesy of CHRYSLER LLC

Reconnect the Left Blend Door Actuator harness connector.

Measure the resistance between the (C54) Driver Blend Door Driver circuit and the (C154) Common Door Driver circuit in the A/C Heater Control C1 harness connector.

**Is the resistance between 30 and 40 ohms?**

Yes

Replace the A/C Heater Control in accordance with the service information.

No

Replace the Mode Door Actuator in accordance with the service information.  
 Perform **BODY VERIFICATION TEST - VER 1** .

#### **B10B1-INFRARED SENSOR THERMISTOR CIRCUIT HIGH**

For complete wiring diagrams refer to **SYSTEM WIRING DIAGRAMS** article.

## 2007 Dodge Nitro R/T

2007 HVAC Heating & Air Conditioning - Electrical Diagnostics - Nitro

### When Monitored:

With the ignition on.

### Set Condition:

If the IR Sensor fails the internal self test.

### Possible Causes

A/C HEATER CONTROL

**NOTE:** This DTC must be active for the results of this test to be valid. Do not perform this test if this DTC is stored. Refer to HVAC System Test (ATC) for stored DTC test procedures.

### Diagnostic Test

#### 1) REPLACE THE A/C HEATER CONTROL

### Repair

Replace the A/C Heater Control in accordance with the service information.

Perform **BODY VERIFICATION TEST - VER 1** .

### B10B4-CABIN HEATER 1 CONTROL CIRCUIT LOW (TIPM)

For complete wiring diagrams refer to **SYSTEM WIRING DIAGRAMS** article.

### When Monitored:

With the ignition on, the Cabin Heater Relay energized.

### Set Condition:

If the Totally Integrated Power Module (TIPM) detects that the (K360) Cabin Heater 1 Relay Control circuit is shorted to ground.

### Possible Causes

(K360) CABIN HEATER 1 RELAY CONTROL CIRCUIT SHORTED TO GROUND

(K360) CABIN HEATER 1 RELAY CONTROL CIRCUIT OPEN

CABIN HEATER RELAY

TOTALLY INTEGRATED POWER MODULE (TIPM)

### Diagnostic Test

**1) VERIFY THAT THE DTC IS ACTIVE**

**WARNING:** When the engine is operating, do not stand in direct line with the fan, do not put your hands near the pulleys, belts or fan. Do not wear loose clothing.

**NOTE:** Before erasing stored DTCs, record these conditions. Attempting to duplicate these conditions may assist when checking for an active DTC.

Turn the ignition on.

With the scan tool, erase DTCs.

With the scan tool, actuate the Cabin Heater Relay.

Monitor the scan tool for at least two minutes.

With the scan tool, read DTCs.

**Does the scan tool display this DTC as active?**

**Yes**

Go to 2).

**No**

The condition that caused this symptom is currently not present. Check for an intermittent condition by inspecting the related wiring harness for chafed, pierced, pinched, and partially broken wires. Also, inspect the related connectors for broken, bent, pushed out, spread, corroded, or contaminated terminals. Repair as necessary.

**2) CHECK (K360) CABIN HEATER 1 RELAY CONTROL CIRCUIT FOR A SHORT TO GROUND**

Turn the ignition off.

Disconnect the TIPM C1 harness connector.

Remove the Cabin Heater Relay.

Measure the resistance between ground and the (K360) Cabin Heater 1 Relay Control circuit in the TIPM C1 harness connector.

**Does the ohm meter read open circuit?**

## 2007 Dodge Nitro R/T

2007 HVAC Heating & Air Conditioning - Electrical Diagnostics - Nitro

**Yes**

Repair the (K360) Cabin Heater 1 Relay Control circuit for a short to ground.  
Perform **BODY VERIFICATION TEST - VER 1** .

**No**

Go to 3).

### **3) CHECK (K360) CABIN HEATER 1 RELAY CONTROL CIRCUIT FOR AN OPEN**

Measure the resistance of the (K360) Cabin Heater 1 Relay Control circuit between the Cabin Heater Relay connector and the TIPM C1 harness connector.

**Does the ohm meter read open circuit?**

**Yes**

Repair the (K360) Cabin Heater 1 Relay Control circuit for an open.  
Perform **BODY VERIFICATION TEST - VER 1** .

**No**

Go to 4).

### **4) CHECK PTC NO. 1 RELAY**

Install the FCM.

Install a substitute PTC No. 1 Relay in place of the vehicle's PTC No. 1 Relay.

Turn the ignition on.

With the scan tool, erase FCM DTCs.

With the scan tool, actuate the PTC No. 1 Relay.

Monitor the scan tool for at least two minutes.

With the scan tool, read FCM DTCs.

**Is the status Active for this DTC?**

**Yes**

Go to 5).

**No**

## 2007 Dodge Nitro R/T

2007 HVAC Heating & Air Conditioning - Electrical Diagnostics - Nitro

Replace the PTC No. 1 Relay in accordance with the Service Information.

Perform **BODY VERIFICATION TEST - VER 1** .

### 5) INSPECT RELATED WIRING & CHECK FOR TSBs

Turn the ignition off.

Using the wiring diagram/schematic as a guide, inspect the wiring and connectors between the PTC No. 1 Relay and the FCM.

Look for any chafed, pierced, pinched, or partially broken wires.

Look for broken, bent, pushed out or corroded terminals.

Refer to any Technical Service Bulletins that may apply.

### Were any problems found?

#### Yes

Repair as necessary.

Perform **BODY VERIFICATION TEST - VER 1** .

#### No

Replace the FCM in accordance with the Service Information.

Perform **BODY VERIFICATION TEST - VER 1** .

### B10B8-CABIN HEATER 2 CONTROL CIRCUIT LOW (TIPM)

For complete wiring diagrams refer to **SYSTEM WIRING DIAGRAMS** article.

#### When Monitored:

With the ignition on, the ASD Relay energized, and the PTC No. 2 Relay command on.

#### Set Condition:

If the Front Control Module (FCM) detects that the (K361) PTC No. 2 Relay Control circuit is shorted to ground.

#### Possible Causes

(K342) FUSED ASD RELAY OUTPUT CIRCUIT OPEN OR HIGH RESISTANCE  
(K361) PTC NO. 2 RELAY CONTROL CIRCUIT SHORTED TO GROUND  
(K361) PTC NO. 2 RELAY CONTROL CIRCUIT OPEN OR HIGH RESISTANCE  
PTC NO. 2 RELAY



FRONT CONTROL MODULE (FCM)

Diagnostic Test

**1) VERIFY THAT THE DTC IS ACTIVE**

**WARNING:** When the engine is operating, do not stand in direct line with the fan. Do not put your hands near the pulleys, belts or fan. Do not wear loose clothing.

**NOTE:** If the FCM detects and stores a DTC, the FCM also stores the environmental conditions under which the DTC was set.

**NOTE:** Before erasing stored DTCs, record these conditions. Attempting to duplicate these conditions may assist when checking for an active DTC.

Turn the ignition on.

With the scan tool, erase FCM DTCs.

With the scan tool, actuate the PTC No. 2 Relay.

Monitor the scan tool for at least two minutes.

With the scan tool, read FCM DTCs.

**Is the status Active for this DTC?**

**Yes**

Go to 2).

**No**

Check for an intermittent condition by inspecting the related wiring harness for chaffed, pierced, pinched, and partially broken wires. Also, inspect the related connectors for broken, bent, pushed out, spread, corroded, or contaminated terminals.

**2) CHECK (K342) FUSED ASD RELAY OUTPUT CIRCUIT FOR AN OPEN OR HIGH RESISTANCE**

Turn the ignition off.

Remove the PTC No. 2 Relay.

Turn the ignition on.

## 2007 Dodge Nitro R/T

2007 HVAC Heating & Air Conditioning - Electrical Diagnostics - Nitro

Using a 12 volt test light connected to ground, check the (K342) Fused ASD Relay Output circuit in the PTC No. 2 Relay harness connector.

**NOTE:**        **The test light should illuminate brightly. Compare the brightness to that of a direct connection to the battery.**

**Does the test light illuminate brightly?**

**Yes**

Go to 3).

**No**

Repair the (K342) Fused ASD Relay Output circuit for an open or high resistance.

Perform **BODY VERIFICATION TEST - VER 1** .

### **3) CHECK (K361) PTC NO. 2 RELAY CONTROL CIRCUIT FOR A SHORT TO GROUND**

Turn the ignition off.

Disconnect the FCM from the Power Module.

Measure the resistance between ground and the (K361) PTC No. 2 Relay Control circuit in the PTC No. 2 Relay connector.

**Is the resistance above 10.0 ohms?**

**Yes**

Go to 4).

**No**

Repair the (K361) PTC No. 2 Relay Control circuit for a short to ground.

Perform **BODY VERIFICATION TEST - VER 1** .

### **4) CHECK (K361) PTC NO. 2 RELAY CONTROL CIRCUIT FOR AN OPEN OR HIGH RESISTANCE**

Measure the resistance of the (K361) PTC No. 2 Relay Control circuit between the PTC No. 2 Relay connector and the FCM connector.

**Is the resistance below 10.0 ohms?**

**Yes**

Go to 5).

**No**

Repair the (K361) PTC No. 2 Relay Control circuit for an open or high resistance.

Perform **BODY VERIFICATION TEST - VER 1** .

**5) CHECK PTC NO. 2 RELAY**

Install the FCM.

Install a substitute PTC No. 2 Relay in place of the vehicle's PTC No. 2 Relay.

Turn the ignition on.

With the scan tool, erase FCM DTCs.

With the scan tool, actuate the PTC No. 2 Relay.

Monitor the scan tool for at least two minutes.

With the scan tool, read FCM DTCs.

**Is the status Active for this DTC?**

**Yes**

Go to 6).

**No**

Replace the PTC No. 2 Relay in accordance with the Service Information.

Perform **BODY VERIFICATION TEST - VER 1** .

**6) INSPECT RELATED WIRING & CHECK FOR TSBs**

Turn the ignition off.

Using the wiring diagram/schematic as a guide, inspect the wiring and connectors between the PTC No. 2 Relay and the FCM.

Look for any chafed, pierced, pinched, or partially broken wires.

Look for broken, bent, pushed out or corroded terminals.

Refer to any Technical Service Bulletins that may apply.

## 2007 Dodge Nitro R/T

2007 HVAC Heating & Air Conditioning - Electrical Diagnostics - Nitro

### Were any problems found?

#### Yes

Repair as necessary.

Perform **BODY VERIFICATION TEST - VER 1** .

#### No

Replace the Front Control Module (FCM) in accordance with the Service Information.

Perform **BODY VERIFICATION TEST - VER 1** .

### **B10B9-CABIN HEATER 2 CONTROL CIRCUIT HIGH (TIPM)**

For complete wiring diagrams refer to **SYSTEM WIRING DIAGRAMS** article.

#### **When Monitored:**

With the ignition on, the ASD Relay energized, and the PTC No. 2 Relay command on.

#### **Set Condition:**

If the Front Control Module (FCM) detects that the (K361) PTC No. 2 Relay Control circuit voltage is shorted to voltage.

Possible Causes
(K361) PTC NO. 2 RELAY CONTROL CIRCUIT SHORTED TO VOLTAGE
(K361) PTC NO. 2 RELAY CONTROL CIRCUIT OPEN OR HIGH RESISTANCE
PTC NO. 2 RELAY
FRONT CONTROL MODULE (FCM)

#### Diagnostic Test

#### 1) VERIFY THAT THE DTC IS ACTIVE

**WARNING:** When the engine is operating, do not stand in direct line with the fan. Do not put your hands near the pulleys, belts or fan. Do not wear loose clothing.

**NOTE:** If the FCM detects and stores a DTC, the FCM also stores the environmental conditions under which the DTC was set.

**NOTE:** Before erasing stored DTCs, record these conditions. Attempting to duplicate these conditions may assist when checking for an active DTC.

## 2007 Dodge Nitro R/T

2007 HVAC Heating & Air Conditioning - Electrical Diagnostics - Nitro

Turn the ignition on.

With the scan tool, erase FCM DTCs.

With the scan tool, actuate the PTC No. 2 Relay.

Monitor the scan tool for at least two minutes.

With the scan tool, read FCM DTCs.

**Is the status Active for this DTC?**

**Yes**

Go to 2).

**No**

Check for an intermittent condition by inspecting the related wiring harness for chaffed, pierced, pinched, and partially broken wires. Also, inspect the related connectors for broken, bent, pushed out, spread, corroded, or contaminated terminals.

### **2) CHECK PTC NO. 2 RELAY**

With the scan tool, erase FCM DTCs.

Turn the ignition off.

Remove the PTC No. 2 Relay.

Turn the ignition on.

With the scan tool, actuate the PTC No. 2 Relay.

With the scan tool, read FCM DTCs.

**NOTE: The scan tool should display an open circuit DTC with the PTC No. 2 Relay removed.**

**Does the scan tool display: B10B9-CABIN HEATER 2 CONTROL CIRCUIT HIGH?**

**Yes**

Go to 3).

**No**

Replace the PTC No. 2 Relay in accordance with the Service Information.

Perform **BODY VERIFICATION TEST - VER 1** .

**3) CHECK (K361) PTC NO. 2 RELAY CONTROL CIRCUIT FOR A SHORT TO VOLTAGE**

Turn the ignition off.

Disconnect the FCM from the Power Module.

Remove the ASD Relay from the IPM.

Connect a jumper wire between cavity 30 and cavity 87 of the ASD Relay Connector.

Turn the ignition on.

Measure the voltage of the (K361) PTC No. 2 Relay Control circuit in the PTC No. 2 Relay connector.

**Is there any voltage present?**

**Yes**

Repair the (K361) PTC No. 2 Relay Control circuit for a short to voltage.

Perform **BODY VERIFICATION TEST - VER 1** .

**No**

Go to 4).

**4) CHECK (K361) PTC NO. 2 RELAY CONTROL FOR AN OPEN OR HIGH RESISTANCE**

Turn the ignition off.

Measure the resistance of the (K361) PTC No. 2 Relay Control circuit between the PTC No. 2 Relay connector and the FCM connector.

**Is the resistance below 10.0 ohms?**

**Yes**

Go to 5).

**No**

Repair the (K361) PTC No. 2 Relay Control circuit for an open or high resistance.

Perform **BODY VERIFICATION TEST - VER 1** .

**5) INSPECT RELATED WIRING & CHECK FOR TSBs**

## 2007 Dodge Nitro R/T

2007 HVAC Heating & Air Conditioning - Electrical Diagnostics - Nitro

Using the wiring diagram/schematic as a guide, inspect the wiring and connectors between the PTC No. 2 Relay and the FCM.

Look for any chafed, pierced, pinched, or partially broken wires.

Look for broken, bent, pushed out or corroded terminals.

Refer to any Technical Service Bulletins that may apply.

### Were any problems found?

#### Yes

Repair as necessary.

Perform **BODY VERIFICATION TEST - VER 1** .

#### No

Replace the FCM in accordance with the Service Information.

Perform **BODY VERIFICATION TEST - VER 1** .

### B10EA-BLOWER MOTOR CONTROL CIRCUIT HIGH

For complete wiring diagrams refer to **SYSTEM WIRING DIAGRAMS** article.

#### When Monitored:

With the ignition on. Battery voltage greater than 10.4 volts. TIPM requesting Blower Motor operation.

#### Set Condition:

If the Totally Integrated Power Module (TIPM) detects a short to voltage condition on the (C7) Blower Motor Control circuit.

#### Possible Causes

(C7) BLOWER MOTOR CONTROL CIRCUIT SHORTED TO VOLTAGE

(C7) BLOWER MOTOR CONTROL CIRCUIT OPEN

BLOWER MOTOR

TOTALLY INTEGRATED POWER MODULE (TIPM)

#### Diagnostic Test

##### 1) VERIFY DTC IS ACTIVE

Turn the ignition on.

With the scan tool, erase DTCs.

Turn the ignition off, wait 10 seconds, and turn the ignition on.

With the A/C control, turn on the Blower Motor.

With the scan tool, read DTCs.

**Does the scan tool display active: B10EA-BLOWER MOTOR CONTROL CIRCUIT HIGH?**

**Yes**

Go to 2).

**No**

The condition that caused this symptom is currently not present. Check for an intermittent condition by inspecting the related wiring harness for chafed, pierced, pinched, and partially broken wires. Also, inspect the related connectors for broken, bent, pushed out, spread, corroded, or contaminated terminals. Repair as necessary.

Perform **BODY VERIFICATION TEST - VER 1** .

**2) CHECK (C7) BLOWER MOTOR CONTROL CIRCUIT FOR AN OPEN**

Turn the ignition off.

Disconnect the TIPM C8 harness connector.

Disconnect the Blower Motor harness connector.

Measure the resistance of the (C7) Blower Motor Control circuit between the TIPM C8 harness connector and the Blower Motor harness connector.

**Does the ohm meter read open circuit?**

**Yes**

Repair the (C7) Blower Motor Control circuit for an open.

Perform **BODY VERIFICATION TEST - VER 1** .

**No**

Go to 3).

**3) CHECK (C7) BLOWER MOTOR CONTROL CIRCUIT FOR SHORT TO VOLTAGE**

Turn the ignition on.



With a volt meter measure the voltage on the (C7) Blower Motor Control circuit.

**Does the volt meter read above 10.0 volts?**

**Yes**

Repair the (C7) Blower Motor Control circuit for a short to voltage.  
Perform **BODY VERIFICATION TEST - VER 1** .

**No**

Go to 4).

**4) TOTALLY INTEGRATED POWER MODULE**

Turn the ignition on.

With the scan tool, erase DTCs.

Turn the ignition off, wait 10 seconds, and turn the ignition on.

With the A/C control, turn on the Blower Motor.

With the scan tool, read DTCs.

**Does the scan tool display active: B10EA-BLOWER MOTOR CONTROL CIRCUIT HIGH?**

**Yes**

Replace the Totally Integrated Power Module (TIPM) in accordance with the service information.  
Perform **BODY VERIFICATION TEST - VER 1** .

**No**

Replace the Blower Motor in accordance with the service information.  
Perform **BODY VERIFICATION TEST - VER 1** .

**B10EC-BLOWER MOTOR CONTROL CIRCUIT OVERCURRENT (TIPM)**

For complete wiring diagrams refer to **SYSTEM WIRING DIAGRAMS** article.

**When Monitored:**

With the ignition on.

**Set Condition:**

## 2007 Dodge Nitro R/T

2007 HVAC Heating & Air Conditioning - Electrical Diagnostics - Nitro

The Totally Integrated Power Module (TIPM) will set this DTC if it detects an overcurrent condition on the (C7) Blower Motor Control circuit for more than 500 ms when blower motor operation is requested.

### Possible Causes

BLOCKAGE STALLING BLOWER MOTOR  
BLOWER MOTOR  
TOTALLY INTEGRATED POWER MODULE (TIPM)

#### Diagnostic Test

#### 1) VERIFY DTC B10EC-BLOWER MOTOR CONTROL CIRCUIT OVERCURRENT IS ACTIVE

Turn the ignition on.

With the scan tool, erase DTCs.

Turn the ignition off, wait 10 seconds, and turn the ignition on.

With the scan tool, read DTCs.

**Does the scan tool display active: B10EC-BLOWER MOTOR CONTROL CIRCUIT OVERCURRENT?**

**Yes**

Go to 2).

**No**

The condition that caused this symptom is currently not present. Check for an intermittent condition by inspecting the related wiring harness for chafed, pierced, pinched, and partially broken wires. Also, inspect the related connectors for broken, bent, pushed out, spread, corroded, or contaminated terminals. Repair as necessary.

Perform **BODY VERIFICATION TEST - VER 1** .

#### 2) CHECK FOR PROPER BLOWER MOTOR OPERATION

Turn the ignition on.

Turn the Blower Motor on.

**Does the Blower Motor operate normally?**

**Yes**

Go to 5).

**No**

Go to 3).

**3) CHECK FOR 12 VOLTS TO THE BLOWER MOTOR**

Turn the ignition off.

Disconnect the Blower Motor harness connector.

Turn the ignition on.

Turn the Blower Motor control on.

Using a volt meter measure the voltage on the (C7) Blower Motor Control circuit in the Blower Motor harness connector.

**Does the volt meter read 12 volts?**

**Yes**

Go to 4).

**No**

Go to 5).

**4) CHECK FOR A BLOCKAGE STALLING THE BLOWER MOTOR**

Turn the ignition off.

Remove the Blower Motor from the HVAC housing assembly.

Look for anything on the Blower Motor and in the HVAC housing that is physically preventing Blower Motor operation.

**Is anything physically preventing Blower Motor operation?**

**Yes**

Repair as necessary. Also, check Blower Motor for proper operation. Reinstall, or replace the Blower Motor as necessary in accordance with the service information.

**No**

Replace the Blower Motor in accordance with the service information.

Perform **BODY VERIFICATION TEST - VER 1** .

**5) CHECK FOR CHAFING IN THE (C7) BLOWER MOTOR CONTROL CIRCUIT**

## 2007 Dodge Nitro R/T

2007 HVAC Heating & Air Conditioning - Electrical Diagnostics - Nitro

Turn the ignition off.

Check the (C7) Blower Motor Control circuit for wire chafing.

**Is any wire chafing present?**

**Yes**

Repair the wire chafing on the (C7) Blower Motor Control circuit.

Perform **BODY VERIFICATION TEST - VER 1** .

**No**

Replace the Totally Integrated Power Module (TIPM) in accordance with the service information.

Perform **BODY VERIFICATION TEST - VER 1** .

### **B1138-CABIN HEATER 3 CONTROL CIRCUIT LOW (TIPM)**

For complete wiring diagrams refer to **SYSTEM WIRING DIAGRAMS** article.

**When Monitored:**

With the ignition on, the Cabin Heater Relay 2 commanded on.

**Set Condition:**

If the Totally Integrated Power Module detects the (K232) Cabin Heater Relay 2 Control circuit is shorted to ground.

#### **Possible Causes**

(K232) CABIN HEATER RELAY 2 CONTROL CIRCUIT SHORTED TO GROUND  
CABIN HEATER 2 RELAY  
TOTALLY INTEGRATED POWER MODULE (TIPM)

**Diagnostic Test**

**1) VERIFY THAT THE DTC IS ACTIVE**

Turn the ignition on.

With the scan tool, erase DTCs.

With the scan tool, actuate the Cabin Heater 2 Relay.

Monitor the scan tool, for at least two minutes.

## 2007 Dodge Nitro R/T

2007 HVAC Heating & Air Conditioning - Electrical Diagnostics - Nitro

With the scan tool, read DTCs.

**Does the scan tool, display active: B10B8-CABIN HEATER 2 CONTROL CIRCUIT LOW?**

**Yes**

Go to 2).

**No**

The condition that caused this symptom is currently not present. Check for an intermittent condition by inspecting the related wiring harness for chafed, pierced, pinched, and partially broken wires. Also, inspect the related connectors for broken, bent, pushed out, spread, corroded, or contaminated terminals. Repair as necessary.

Perform **BODY VERIFICATION TEST - VER 1** .

**2) CHECK (K232) CABIN HEATER RELAY 2 OUTPUT CIRCUIT FOR SHORT TO GROUND**

Turn the ignition off.

Disconnect the TIPM C1 harness connector.

Remove the Cabin Heater Relay 2.

Using an ohm meter measure the resistance between the (K232) Cabin Heater Relay 2 Output circuit and ground.

**Does the ohm meter read open circuit?**

**Yes**

Go to 3).

**No**

Repair the (K232) Cabin Heater Relay 2 Output circuit for a short to ground.

Perform **BODY VERIFICATION TEST - VER 1** .

**3) TOTALLY INTEGRATED POWER MODULE (TIPM)**

Turn the ignition on.

With the scan tool, erase DTCs.

With the scan tool, actuate the Cabin Heater 2 Relay.

Monitor the scan tool for at least two minutes.

## 2007 Dodge Nitro R/T

2007 HVAC Heating & Air Conditioning - Electrical Diagnostics - Nitro

With the scan tool, read DTCs.

**Does the scan tool display active: B10B8-CABIN HEATER 2 CONTROL CIRCUIT LOW?**

**Yes**

Replace the Totally Integrated Power Module (TIPM) in accordance with the service information.  
Perform **BODY VERIFICATION TEST - VER 1** .

**No**

Replace the Cabin Heater Relay 2 in accordance with the service information.  
Perform **BODY VERIFICATION TEST - VER 1** .

**B1139-CABIN HEATER 3 CONTROL CIRCUIT HIGH (TIPM)**

For complete wiring diagrams refer to **SYSTEM WIRING DIAGRAMS** article.

**When Monitored:**

With the ignition on, the Cabin Heater Relay 2 is commanded on.

**Set Condition:**

If the Totally Integrated Power Module detects a short to voltage on the (K232) Cabin Heater Relay 2 Control circuit.

### Possible Causes

(K232) CABIN HEATER RELAY 2 CONTROL CIRCUIT SHORTED TO VOLTAGE  
CABIN HEATER RELAY 2  
TOTALLY INTEGRATED POWER MODULE (TIPM)

**Diagnostic Test**

**1) VERIFY THAT THE DTC IS ACTIVE**

Turn the ignition on.

With the scan tool, erase DTCs.

With the scan tool, actuate the Cabin Heater 2 Relay.

Monitor the scan tool for at least two minutes.

With the scan tool, read DTCs.

**Does the scan tool, display active: B10B9-CABIN HEATER 2 CONTROL CIRCUIT HIGH?**

**Yes**

Go to 2).

**No**

The condition that caused this symptom is currently not present. Check for an intermittent condition by inspecting the related wiring harness for chafed, pierced, pinched, and partially broken wires. Also, inspect the related connectors for broken, bent, pushed out, spread, corroded, or contaminated terminals. Repair as necessary.

Perform **BODY VERIFICATION TEST - VER 1** .

**2) CHECK THE (K232) CABIN HEATER RELAY 2 CONTROL CIRCUIT FOR SHORT TO VOLTAGE**

Turn the ignition off.

Disconnect the TIPM C1 harness connector.

Remove the Cabin Heater Relay 2.

Turn the ignition on.

With a volt meter, measure the voltage on the (K232) Cabin Heater Relay 2 Control circuit.

**Does the volt meter read 1.0 volt or above?**

**Yes**

Repair short to voltage on the (K232) Cabin Heater Relay 2 Control circuit.

Perform **BODY VERIFICATION TEST - VER 1** .

**No**

Go to 3).

**3) TOTALLY INTEGRATED POWER MODULE**

Turn the ignition on.

With the scan tool, erase DTCs.

With the scan tool, actuate the Cabin Heater 2 Relay.

Monitor the scan tool for at least two minutes.

## 2007 Dodge Nitro R/T

2007 HVAC Heating & Air Conditioning - Electrical Diagnostics - Nitro

With the scan tool, read DTCs.

**Does the scan tool display active: B10B9-CABIN HEATER 2 CONTROL CIRCUIT HIGH?**

**Yes**

Replace the Totally Integrated Power Module (TIPM) in accordance with the service information.  
Perform **BODY VERIFICATION TEST - VER 1** .

**No**

Replace the Cabin Heater Relay 2 in accordance with the service information.  
Perform **BODY VERIFICATION TEST - VER 1** .

### **B1610-AMBIENT LIGHT SENSOR INPUT CIRCUIT LOW**

For complete wiring diagrams refer to **SYSTEM WIRING DIAGRAMS** article.

#### **When Monitored:**

With the ignition on.

#### **Set Condition:**

If the Ambient Light Sensor input is out of range toward the low voltage threshold.

#### **Possible Causes**

(L24) AUTO HEADLAMPS SIGNAL CIRCUIT SHORTED TO GROUND  
SUNLOAD SENSOR  
A/C HEATER CONTROL

#### **Diagnostic Test**

##### **1) VERIFY THE DTC IS ACTIVE**

Turn the ignition switch on.

With a scan tool, read and record DTCs.

With the scan tool, clear DTCs.

Turn the ignition switch off, and then on.

Using the scan tool, read DTCs.

**Does the scan tool display this DTC as active?**



## 2007 Dodge Nitro R/T

2007 HVAC Heating & Air Conditioning - Electrical Diagnostics - Nitro

**Yes**

Go to 2).

**No**

The condition that caused this symptom is currently not present. Check for an intermittent condition by inspecting the related wiring harness for chafed, pierced, pinched, and partially broken wires. Also, inspect the related connectors for broken, bent, pushed out, spread, corroded, or contaminated terminals. Repair as necessary.

Perform **BODY VERIFICATION TEST - VER 1** .

### **2) CHECK FOR ACTIVE DTC WITH SUNLOAD SENSOR HARNESS CONNECTOR DISCONNECTED**

Turn the ignition off.

Disconnect the Sunload Sensor harness connector.

Turn the ignition on.

With the scan tool, erase HVAC DTCs.

Turn the ignition off, wait 10 seconds, and turn the ignition on.

With the scan tool, read HVAC DTCs.

**Does the scan tool display this DTC as active?**

**Yes**

Go to 3).

**No**

Replace the Sunload Sensor in accordance with the service information.

Perform **BODY VERIFICATION TEST - VER 1** .

### **3) CHECK (L24) AUTO HEADLAMPS SIGNAL CIRCUIT FOR A SHORT TO GROUND**

Turn the ignition off.

Disconnect the A/C Heater Control C1 harness connector.

Measure the resistance of the (L24) Auto Headlamps Signal circuit between ground and the A/C Heater Control C1 harness connector.

**Does the ohm meter read open circuit?**

## 2007 Dodge Nitro R/T

2007 HVAC Heating & Air Conditioning - Electrical Diagnostics - Nitro

### Yes

Replace the A/C Heater Control in accordance with the service information.

Perform **BODY VERIFICATION TEST - VER 1** .

### No

Repair the (L24) Auto Headlamps Signal circuit for a short to ground.

Perform **BODY VERIFICATION TEST - VER 1** .

### **B1610-AMBIENT LIGHT SENSOR INPUT CIRCUIT PERFORMANCE**

For complete wiring diagrams refer to **SYSTEM WIRING DIAGRAMS** article.

#### **When Monitored:**

With the ignition on.

#### **Set Condition:**

If the Ambient Light Sensor input is out of range.

#### **Possible Causes**

(L24) AUTO HEADLAMPS SIGNAL CIRCUIT OPEN  
(L24) AUTO HEADLAMPS SIGNAL CIRCUIT SHORTED TO GROUND  
(C121) SENSOR GROUND OPEN  
SUNLOAD SENSOR  
A/C HEATER CONTROL

#### **Diagnostic Test**

##### **1) ACTIVE DTC(S) PRESENT**

Turn the ignition on.

With the scan tool, check for DTCs.

**Does the scan tool display this DTC as active?**

### Yes

Go to 2).

### No

The condition that caused this symptom is currently not present. Check for an intermittent

condition by inspecting the related wiring harness for chafed, pierced, pinched, and partially broken wires. Also, inspect the related connectors for broken, bent, pushed out, spread, corroded, or contaminated terminals. Repair as necessary.

Perform **BODY VERIFICATION TEST - VER 1** .

**2) CHECK (L24) AUTO HEADLAMPS SIGNAL CIRCUIT FOR AN OPEN**

Turn the ignition off.

Disconnect the A/C Heater Control C1 harness connector.

Disconnect the Sunload Sensor harness connector.

Measure the resistance of the (L24) Auto Headlamps Signal circuit between the Sunload Sensor harness connector and the A/C Heater Control C1 harness connector.

**Does the ohm meter read open circuit?**

**Yes**

Repair the (L24) Auto Headlamps Signal circuit for an open.

Perform **BODY VERIFICATION TEST - VER 1** .

**No**

Go to 3).

**3) CHECK (L24) AUTO HEADLAMPS SIGNAL CIRCUIT FOR A SHORT TO GROUND**

Measure the resistance between ground and the (L24) Auto Headlamps Signal circuit in the A/C Heater Control C1 harness connector.

**Does the ohm meter read open circuit?**

**Yes**

Go to 4).

**No**

Repair the (L24) Auto Headlamps Signal circuit for a short to ground.

Perform **BODY VERIFICATION TEST - VER 1** .

**4) CHECK (C121) SENSOR GROUND CIRCUIT FOR AN OPEN**

Measure the resistance of the (C121) Sensor Ground circuit between the Sunload Sensor harness connector and the A/C Heater Control C1 harness connector.

**Does the ohm meter read open circuit?**

**Yes**

Repair the (C121) Sensor Ground circuit for an open.  
Perform **BODY VERIFICATION TEST - VER 1** .

**No**

Go to 5).

**5) CHECK THE SUNLOAD SENSOR**

Reconnect the A/C Heater Control C1 harness connector.

Turn the ignition on.

Using the scan tool, observe the Auto Headlamp signal while connecting a jumper wire between the (L24) Auto Headlamps Signal circuit and the (C121) Sensor Ground circuit in the Sunload Sensor harness connector.

**Does the Auto Headlamp signal change from approximately 5 volts to 0 volts?**

**Yes**

Replace the Sunload Sensor in accordance with the service information.  
Perform **BODY VERIFICATION TEST - VER 1** .

**No**

Replace the A/C Heater Control in accordance with the service information.  
Perform **BODY VERIFICATION TEST - VER 1** .

**B1611-AMBIENT LIGHT SENSOR INPUT CIRCUIT HIGH**

For complete wiring diagrams refer to **SYSTEM WIRING DIAGRAMS** article.

**When Monitored:**

With the ignition on.

**Set Condition:**

If the Ambient Light Sensor input is out of range toward the high voltage threshold.

**Possible Causes**

## 2007 Dodge Nitro R/T

2007 HVAC Heating & Air Conditioning - Electrical Diagnostics - Nitro

(L24) AUTO HEADLAMPS SIGNAL CIRCUIT SHORTED TO VOLTAGE  
SUNLOAD SENSOR  
A/C HEATER CONTROL

### Diagnostic Test

#### 1) CHECK FOR ACTIVE DTC WITH THE SUNLOAD SENSOR HARNESS CONNECTOR DISCONNECTED

Turn the ignition off.

Disconnect the Sunload Sensor harness connector.

Turn the ignition on.

With the scan tool, erase HVAC DTCs.

Turn the ignition off, wait 10 seconds, and turn the ignition on.

With the scan tool, read HVAC DTCs.

**Does the scan tool display this DTC as active?**

**Yes**

Go to 2).

**No**

Replace the Sunload Sensor in accordance with the service information.

Perform **BODY VERIFICATION TEST - VER 1** .

#### 2) CHECK (L24) AUTO HEADLAMPS SIGNAL CIRCUIT FOR A SHORT TO VOLTAGE

Turn the ignition off.

Disconnect the A/C Heater Control C1 harness connector.

Measure the voltage of the (L24) Auto Headlamps Signal circuit between ground and the A/C Heater Control C1 harness connector.

**Is there any voltage present?**

**Yes**

Repair the (L24) Auto Headlamps Signal circuit for a short to voltage.

**2007 Dodge Nitro R/T**

2007 HVAC Heating & Air Conditioning - Electrical Diagnostics - Nitro

Perform **BODY VERIFICATION TEST - VER 1** .

**No**

Replace the A/C Heater Control in accordance with the service information.

Perform **BODY VERIFICATION TEST - VER 1** .

**B210A-SYSTEM VOLTAGE LOW**

# 2007 Dodge Nitro R/T

## 2007 HVAC Heating & Air Conditioning - Electrical Diagnostics - Nitro

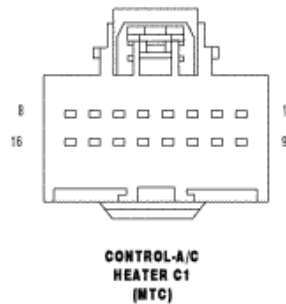
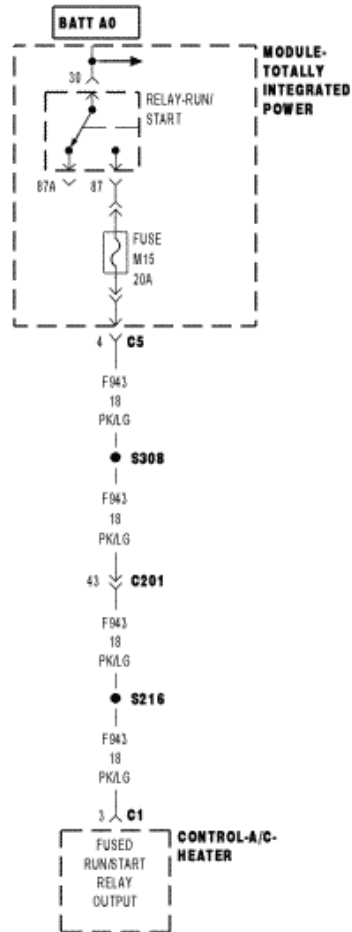

FIGURE

**Fig. 56: Fused Run-Start Relay Output Circuit Schematic**  
Courtesy of CHRYSLER LLC

For complete wiring diagrams refer to **SYSTEM WIRING DIAGRAMS** article.

**When Monitored:**

## 2007 Dodge Nitro R/T

2007 HVAC Heating & Air Conditioning - Electrical Diagnostics - Nitro

With the ignition switch on.

### Set Condition:

The A/C Heater Control has detected the system voltage is low.

### Possible Causes

(F943) FUSED RUN-START RELAY OUTPUT CIRCUIT OPEN  
A/C HEATER CONTROL

### Diagnostic Test

#### 1) VERIFY THE DTC IS ACTIVE

**NOTE:** Diagnose any related Powertrain DTCs before continuing.

Turn the ignition switch on.

With a scan tool, read and record DTCs.

With the scan tool, clear DTCs.

Turn the ignition switch off, and then on.

Using the scan tool, read DTCs.

**Does the scan tool display this DTC as active?**

**Yes**

Go to 2).

**No**

The condition that caused this symptom is currently not present. Check for an intermittent condition by inspecting the related wiring harness for chafed, pierced, pinched, and partially broken wires. Also, inspect the related connectors for broken, bent, pushed out, spread, corroded, or contaminated terminals. Repair as necessary.

Perform **BODY VERIFICATION TEST - VER 1** .

#### 2) (F943) FUSED RUN-START RELAY OUTPUT CIRCUIT OPEN



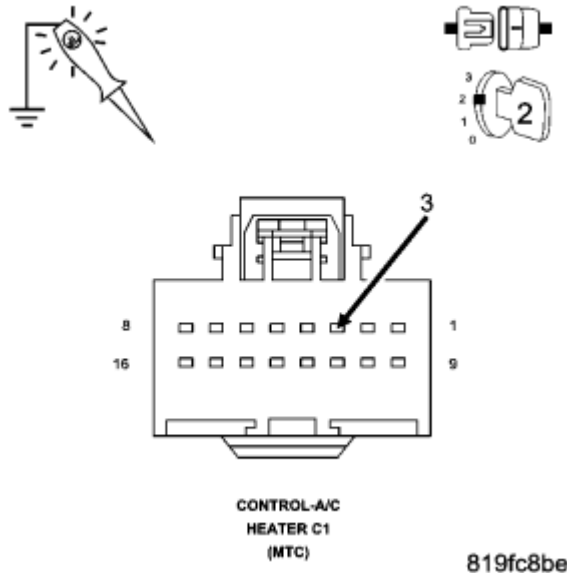

**Fig. 57: Using 12 Volt Test Light Connected To Ground To Probe (F943) Fused Run-Start Relay Output Circuit In A/C Heater Control C1 Harness Connector**  
 Courtesy of CHRYSLER LLC

**NOTE:** Check the related fuses to the Fused Ignition Switch Output (Run-Start) circuit. If the fuse is found to be open repair the circuit for a shorted condition.

Turn the ignition off.

Disconnect the A/C Heater Control C1 harness connector.

Turn the ignition on.

Using a 12 volt test light connected to ground, probe the (F943) Fused Run-Start Relay Output circuit in the A/C Heater Control C1 harness connector.

**Does the test light illuminate brightly?**

**Yes**

Go to 3).

**No**

Repair the (F943) Fused Run-Start Relay Output circuit for an open.

Perform **BODY VERIFICATION TEST - VER 1** .

**3) CHECK THE A/C HEATER CONTROL**

## 2007 Dodge Nitro R/T

2007 HVAC Heating & Air Conditioning - Electrical Diagnostics - Nitro

**NOTE:**        **A dirty (partial) ground can cause abnormal conditions within a system. Make sure the module has a good ground before continuing.**

Turn the ignition off.

Reconnect the A/C Heater Control C1 harness connector.

While back probing, measure the voltage of the (F943) Fused Run-Start Relay Output circuit in the A/C Heater Control C1 harness connector.

Start the engine.

Using the scan tool, view battery voltage under Data Display in the Engine category.

Compare the voltage on the scan tool to the voltage reading on the voltmeter.

**Is the voltage on the scan tool equal to the voltmeter reading within +/- 0.5 volt?**

**Yes**

Replace the A/C Heater Control in accordance with the service information.

Perform **BODY VERIFICATION TEST - VER 1** .

**No**

Repair the circuit(s) that indicated the incorrect voltage.

Perform **SKREEM/SKIM VERIFICATION TEST** .

**B210B-SYSTEM VOLTAGE HIGH**

# 2007 Dodge Nitro R/T

## 2007 HVAC Heating & Air Conditioning - Electrical Diagnostics - Nitro

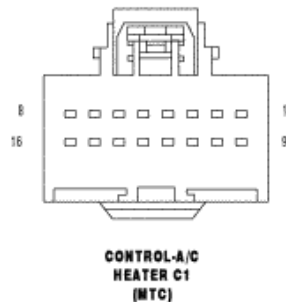
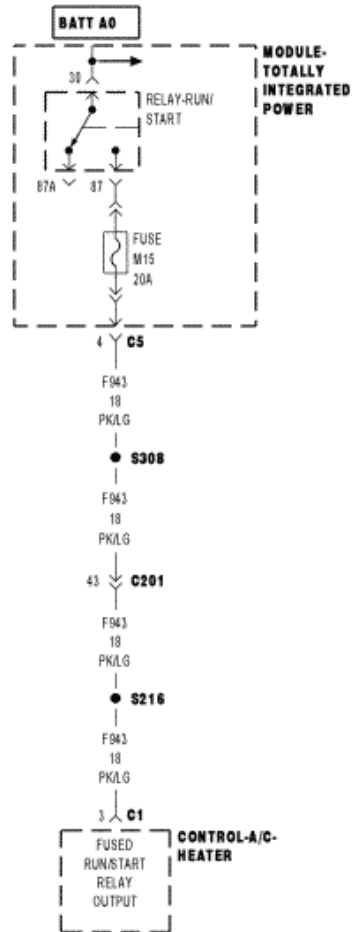

FIGURE

**Fig. 58: Fused Run-Start Relay Output Circuit Schematic**  
Courtesy of CHRYSLER LLC

For complete wiring diagrams refer to **SYSTEM WIRING DIAGRAMS** article.

**When Monitored:**

## 2007 Dodge Nitro R/T

2007 HVAC Heating & Air Conditioning - Electrical Diagnostics - Nitro

With the ignition switch on.

### Set Condition:

The A/C Heater Control has detected the system voltage is high.

### Possible Causes

(F943) FUSED RUN-START RELAY OUTPUT CIRCUIT SHORTED TO VOLTAGE  
A/C HEATER CONTROL

### Diagnostic Test

#### 1) ACTIVE DTC(S) PRESENT

Turn the ignition on.

With the scan tool, check for DTCs.

**Does the scan tool display this DTC as active?**

**Yes**

Go to 2).

**No**

The condition that caused this symptom is currently not present. Check for an intermittent condition by inspecting the related wiring harness for chafed, pierced, pinched, and partially broken wires. Also, inspect the related connectors for broken, bent, pushed out, spread, corroded, or contaminated terminals. Repair as necessary.

Perform **BODY VERIFICATION TEST - VER 1** .

**2) CHECK (F943) FUSED RUN-START RELAY OUTPUT CIRCUIT FOR A SHORT TO BATTERY VOLTAGE**

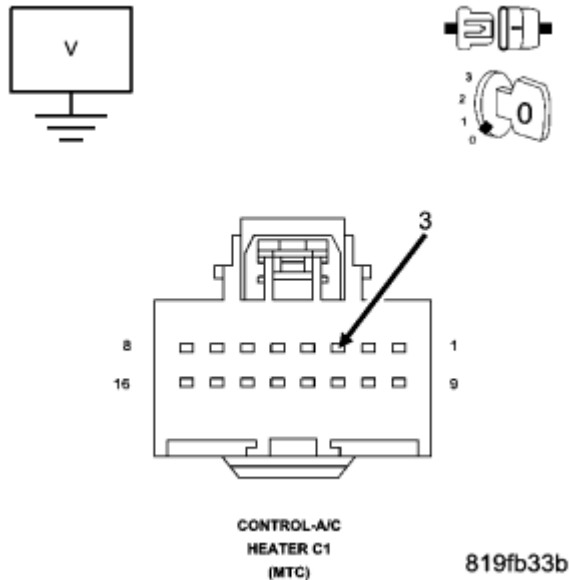

**Fig. 59: Using Volt Meter Measure Voltage On (F943) Fused Run-Start Relay Output Circuit In A/C Heater Control C1 Harness Connector**  
Courtesy of CHRYSLER LLC

Turn the ignition off.

Disconnect the A/C Heater Control C1 harness connector.

Using a volt meter measure the voltage on the (F943) Fused Run-Start Relay Output circuit in the A/C Heater Control C1 harness connector.

**Is there any voltage present?**

**Yes**

Repair the (F943) Fused Run-Start Relay Output circuit for a short to voltage.

Perform **BODY VERIFICATION TEST - VER 1** .

**No**

Replace the A/C Heater Control in accordance with the service information.

Perform **BODY VERIFICATION TEST - VER 1** .

**B2214-(HVAC) CLIMATE CONTROL INTERNAL**

For complete wiring diagrams refer to **SYSTEM WIRING DIAGRAMS** article.

**When Monitored:**

## 2007 Dodge Nitro R/T

2007 HVAC Heating & Air Conditioning - Electrical Diagnostics - Nitro

With the ignition on.

### Set Condition:

If the A/C Heater Control has an internal fault. This DTC has a maturing time of 5 seconds and a de-maturing time of 10 seconds. If the DTC's status changes from active to stored it will stay in memory for 100 ignition cycles.

### Possible Causes

A/C HEATER CONTROL

### Diagnostic Test

#### 1) ACTIVE DTC(S) PRESENT

Turn the ignition on.

With the scan tool, check for DTCs.

**Does the scan tool display this DTC as active?**

**Yes**

Replace the A/C Heater Control in accordance with the service information.  
Perform **BODY VERIFICATION TEST - VER 1** .

**No**

The condition that caused this symptom is currently not present. Check for an intermittent condition by inspecting the related wiring harness for chafed, pierced, pinched, and partially broken wires. Also, inspect the related connectors for broken, bent, pushed out, spread, corroded, or contaminated terminals. Repair as necessary.

Perform **BODY VERIFICATION TEST - VER 1** .

### B222A-VEHICLE LINE MISMATCH

For complete wiring diagrams refer to **SYSTEM WIRING DIAGRAMS** article.

### When Monitored:

With the ignition on.

### Set Condition:

The A/C Heater Control will receive and monitor the vehicle line message from the PCM and record the vehicle line if different from the last vehicle line.

## 2007 Dodge Nitro R/T

2007 HVAC Heating & Air Conditioning - Electrical Diagnostics - Nitro

### Possible Causes

PCM

A/C HEATER CONTROL

#### Diagnostic Test

##### 1) ACTIVE DTC(S) PRESENT

Turn the ignition on.

With the scan tool, check for DTCs.

**Does the scan tool display this DTC as active?**

**Yes**

Go to 2).

**No**

The condition that caused this symptom is currently not present. Check for an intermittent condition by inspecting the related wiring harness for chafed, pierced, pinched, and partially broken wires. Also, inspect the related connectors for broken, bent, pushed out, spread, corroded, or contaminated terminals. Repair as necessary.

Perform **BODY VERIFICATION TEST - VER 1** .

##### 2) CHECK VEHICLE LINE IN PCM

With the scan tool compare the vehicle line that is programmed into the PCM to the vehicle line of the vehicle.

**Does the vehicle line programmed into the PCM match the vehicle?**

**Yes**

Inspect the wiring and connectors for damage or shorted circuits. If ok, replace and program the A/C Heater Control in accordance with the service information.

Perform **BODY VERIFICATION TEST - VER 1** .

**No**

Replace and program the Powertrain Control Module in accordance with the service information. Ensure the PCM is replaced with the correct vehicle line PCM.

Perform **POWERTRAIN VERIFICATION TEST** .

## 2007 Dodge Nitro R/T

2007 HVAC Heating & Air Conditioning - Electrical Diagnostics - Nitro

For complete wiring diagrams refer to **SYSTEM WIRING DIAGRAMS** article.

### **When Monitored:**

Continuously

### **Set Condition:**

If the CAN Interior Bus (+) or CAN Interior Bus (-) circuit is open, shorted to voltage, or shorted to ground.

### **Possible Causes**

ACTIVE CAN BUS DTC IN THE TOTALLY INTEGRATED POWER CONTROL MODULE  
(D265) CAN C INTERIOR BUS (125K) (+) CIRCUIT OPEN  
(D264) CAN C INTERIOR BUS (125K) (-) CIRCUIT OPEN  
A/C HEATER CONTROL

### **Diagnostic Test**

#### **1) VERIFY THE DTC IS ACTIVE**

Turn the ignition on.

With the scan tool, read HVAC DTCs.

**Does the scan tool display this DTC as active?**

**Yes**

Go to 2).

**No**

If the DTC is stored, check for an intermittent condition by inspecting the related wiring harness for chafed, pierced, pinched, and partially broken wires. Also, inspect the related connectors for broken, bent, pushed out, spread, corroded, or contaminated terminals.

Perform **BODY VERIFICATION TEST - VER 1** .

#### **2) CHECK FOR ACTIVE CAN BUS RELATED DTCS IN THE TOTALLY INTEGRATE POWER MODULE (TIPM)**

With the scan tool, read the Totally Integrated Power Module (TIPM) DTCs

**Does the scan tool display any active CAN BUS related DTCs?**

**Yes**



Diagnose and repair the DTC(s).

Perform **BODY VERIFICATION TEST - VER 1** .

**No**

Go to 3).

**3) CHECK (D265) CAN INTERIOR BUS (+) CIRCUIT FOR AN OPEN**

Turn the ignition off.

Disconnect the negative battery cable.

Disconnect the A/C Heater Control C1 harness connector.

Disconnect the Totally Integrated Power Module (TIPM) C7 harness connector.

Measure the resistance of the (D265) CAN Interior Bus (+) circuit between the Totally Integrated Power Module (TIPM) C7 harness connector and the A/C Heater Control C1 harness connector.

**Is the resistance below 2.0 ohms?**

**Yes**

Go to 4).

**No**

Repair the (D265) CAN Interior Bus (+) circuit for an open.

Perform **BODY VERIFICATION TEST - VER 1** .

**4) CHECK (D264) CAN INTERIOR BUS (-) CIRCUIT FOR AN OPEN**

Measure the resistance of the (D264) CAN Interior Bus (-) circuit between the Totally Integrated Power Module (TIPM) C7 connector and the A/C Heater Control C1 harness connector.

**Is the resistance below 2.0 ohms?**

**Yes**

Go to 5).

**No**

Repair the (D264) CAN Interior Bus (-) circuit for an open.

Perform **BODY VERIFICATION TEST - VER 1** .

**5) CHECK (D265) CAN C INTERIOR BUS (+) CIRCUIT FOR A SHORT TO GROUND**

## 2007 Dodge Nitro R/T

2007 HVAC Heating & Air Conditioning - Electrical Diagnostics - Nitro

Measure the resistance between ground and the (D265) CAN C Interior Bus (125K) (+) circuit in the A/C Heater Control C1 harness connector.

**Is the resistance above 1000.0 ohms?**

**Yes**

Go to 6).

**No**

Repair the (D265) CAN C Interior Bus (+) circuit for a short to ground.

Perform **BODY VERIFICATION TEST - VER 1** .

### **6) CHECK (D264) CAN C INTERIOR BUS (-) CIRCUIT FOR A SHORT TO GROUND**

Measure the resistance between ground and the (D264) CAN C Interior Bus (125K) (-) circuit in the A/C Heater Control C1 harness connector.

**Is the resistance above 1000.0 ohms?**

**Yes**

Go to 7).

**No**

Repair the (D264) CAN C Interior Bus (-) circuit for a short to ground.

Perform **BODY VERIFICATION TEST - VER 1** .

### **7) CHECK (D265) CAN C INTERIOR BUS (+) CIRCUIT FOR A SHORT TO VOLTAGE**

Turn the ignition on.

Measure the voltage of the (D265) CAN C Interior Bus (125K) (+) circuit in the A/C Heater Control C1 harness connector.

**Is the voltage below 0.2 volts?**

**Yes**

Go to 8).

**No**

Repair the (D265) CAN C Interior Bus (+) circuit for a short to voltage.

Perform **BODY VERIFICATION TEST - VER 1** .

**8) CHECK (D264) CAN C INTERIOR BUS (-) CIRCUIT FOR A SHORT TO VOLTAGE**

Measure the voltage of the (D264) CAN C Interior Bus (125K) (-) circuit in the A/C Heater Control C1 harness connector.

**Is the voltage below 0.2 volts?**

**Yes**

Replace the A/C Heater Control in accordance with the Service Information.  
Perform **BODY VERIFICATION TEST - VER 1** .

**No**

Repair the (D264) CAN C Interior Bus (-) circuit for a short to voltage.  
Perform **BODY VERIFICATION TEST - VER 1** .

**U0141-LOST COMM W/INTEGRATED POWER MODULE/FRONT CONTROL MODULE/TIPM**

For complete wiring diagrams refer to **SYSTEM WIRING DIAGRAMS** article.

**When Monitored:**

With the ignition on.

**Set Condition:**

If the A/C Heater Control loses communication with the Totally Integrated Power Module (TIPM).

Refer to **DIAGNOSIS AND TESTING** for the diagnostic test procedure.

**U0151-LOST COMMUNICATION WITH OCCUPANT RESTRAINT CONTROLLER (ORC)**

For complete wiring diagrams refer to **SYSTEM WIRING DIAGRAMS** article.

**When Monitored:**

With the ignition on.

**Set Condition:**

If the A/C Heater Control loses communication with the Occupant Restraint Controller (ORC).

Refer to **DIAGNOSIS AND TESTING** for the diagnostic test procedure.

**U0154-LOST COMMUNICATION WITH OCCUPANT CLASSIFICATION MODULE**

For complete wiring diagrams refer to **SYSTEM WIRING DIAGRAMS** article.

**When Monitored:**

With the ignition on.

**Set Condition:**

If the A/C Heater Control loses communication with the Occupant Classification Module (OCM).

Refer to **DIAGNOSIS AND TESTING** for the diagnostic test procedure.

**U0155-LOST COMMUNICATION WITH CLUSTER/CCN**

For complete wiring diagrams refer to **SYSTEM WIRING DIAGRAMS** article.

**When Monitored:**

With the ignition on.

**Set Condition:**

If the A/C Heater Control loses communication with the Cluster (CCN).

Refer to **DIAGNOSIS AND TESTING** for the diagnostic test procedure.

**U0159-LOST COMMUNICATION WITH PARKING ASSIST CONTROL MODULE**

For complete wiring diagrams refer to **SYSTEM WIRING DIAGRAMS** article.

**When Monitored:**

With the ignition on.

**Set Condition:**

If the A/C Heater Control loses communication with the Parktronics (PTS).

Refer to **DIAGNOSIS AND TESTING** for the diagnostic test procedure.

**U0167-LOST COMMUNICATION WITH INTRUSION TRANSCIEVER CONTROL MODULE**

For complete wiring diagrams refer to **SYSTEM WIRING DIAGRAMS** article.

**When Monitored:**

With the ignition on.

**Set Condition:**

If the A/C Heater Control loses communication with the Intrusion Transceiver Control Module (ITM).

Refer to **DIAGNOSIS AND TESTING** for the diagnostic test procedure.

**U0168-LOST COM WITH VEHICLE SECURITY CONTROL MODULE (SKREEM/WCM)**

For complete wiring diagrams refer to **SYSTEM WIRING DIAGRAMS** article.

**When Monitored:**

With the ignition on.

**Set Condition:**

If the A/C Heater Control loses communication with the Vehicle Security Control Module (SKREEM/WCM).

Refer to **DIAGNOSIS AND TESTING** for the diagnostic test procedure.

**U0169-LOST COMMUNICATION WITH SUNROOF CONTROL MODULE**

For complete wiring diagrams refer to **SYSTEM WIRING DIAGRAMS** article.

**When Monitored:**

With the ignition on.

**Set Condition:**

If the A/C Heater Control loses communication with the Sunroof Control Module (SCM).

Refer to **DIAGNOSIS AND TESTING** for the diagnostic test procedure.

**U0181-LOST COMMUNICATION WITH HEADLAMP LEVELING TRANSLATOR**

For complete wiring diagrams refer to **SYSTEM WIRING DIAGRAMS** article.

**When Monitored:**

With the ignition on.

**Set Condition:**

If the A/C Heater Control loses communication with the Headlamp Leveling Translator.

Refer to **DIAGNOSIS AND TESTING** for the diagnostic test procedure.

**U0184-LOST COMMUNICATION WITH RADIO**

For complete wiring diagrams refer to **SYSTEM WIRING DIAGRAMS** article.

**When Monitored:**

With the ignition on.

**Set Condition:**

If the A/C Heater Control loses communication with the Radio.

Refer to **DIAGNOSIS AND TESTING** for the diagnostic test procedure.

**U0186-LOST COMMUNICATION WITH AUDIO AMPLIFIER**

For complete wiring diagrams refer to **SYSTEM WIRING DIAGRAMS** article.

**When Monitored:**

With the ignition on.

**Set Condition:**

If the A/C Heater Control loses communication with the Amplifier (AMP).

Refer to **DIAGNOSIS AND TESTING** for the diagnostic test procedure.

**U0187-LOST COMMUNICATION WITH DVD PLAYER**

For complete wiring diagrams refer to **SYSTEM WIRING DIAGRAMS** article.

**When Monitored:**

With the ignition on.

**Set Condition:**

If the A/C Heater Control loses communication with the DVD Player.

Refer to **DIAGNOSIS AND TESTING** for the diagnostic test procedure.

**U0196-LOST COMMUNICATION WITH VEHICLE ENTERTAINMENT CONTROL MODULE**

For complete wiring diagrams refer to **SYSTEM WIRING DIAGRAMS** article.

**When Monitored:**

With the ignition on.

**Set Condition:**

If the A/C Heater Control loses communication with the Vehicle Entertainment System (VES).

Refer to **DIAGNOSIS AND TESTING** for the diagnostic test procedure.

**U0197-LOST COMMUNICATION WITH HANDS FREE PHONE MODULE**

For complete wiring diagrams refer to **SYSTEM WIRING DIAGRAMS** article.

**When Monitored:**

With the ignition on.

**Set Condition:**

If the A/C Heater Control loses communication with the Hands Free Phone Module (HFM).

Refer to **DIAGNOSIS AND TESTING** for the diagnostic test procedure.

**U0200-LOST COMMUNICATION WITH PASSENGER DOOR MODULE**

For complete wiring diagrams refer to **SYSTEM WIRING DIAGRAMS** article.

**When Monitored:**

With the ignition on.

**Set Condition:**

If the A/C Heater Control loses communication with the Passenger Door Module (PDM).

Refer to **DIAGNOSIS AND TESTING** for the diagnostic test procedure.

**U0201-LOST COMMUNICATION WITH LEFT REAR DOOR MODULE**

For complete wiring diagrams refer to **SYSTEM WIRING DIAGRAMS** article.

**When Monitored:**

With the ignition on.

**Set Condition:**

If the A/C Heater Control loses communication with the Left Rear Door Module (LRDM).

Refer to **DIAGNOSIS AND TESTING** for the diagnostic test procedure.

**U0202-LOST COMMUNICATION WITH RIGHT REAR DOOR MODULE**

For complete wiring diagrams refer to **SYSTEM WIRING DIAGRAMS** article.

**When Monitored:**

With the ignition on.

**Set Condition:**

If the A/C Heater Control loses communication with the Right Rear Door Module (LRDM).

Refer to **DIAGNOSIS AND TESTING** for the diagnostic test procedure.

**U0203-LOST COMMUNICATION WITH DOOR MODULE FRONT LEFT**

For complete wiring diagrams refer to **SYSTEM WIRING DIAGRAMS** article.

**When Monitored:**

With the ignition on.

**Set Condition:**

If the A/C Heater Control loses communication with the Left Front Door Module (LRDM).

Refer to **DIAGNOSIS AND TESTING** for the diagnostic test procedure.

**U0203-LOST COMMUNICATION WITH DOOR MODULE FRONT RIGHT**

For complete wiring diagrams refer to **SYSTEM WIRING DIAGRAMS** article.

**When Monitored:**

With the ignition on.

**Set Condition:**

If the A/C Heater Control loses communication with the Right Front Door Module (LRDM).

Refer to **DIAGNOSIS AND TESTING** for the diagnostic test procedure.

**U0209-LOST COMMUNICATION WITH MEMORY SEAT CONTROL MODULE**



For complete wiring diagrams refer to **SYSTEM WIRING DIAGRAMS** article.

**When Monitored:**

With the ignition on.

**Set Condition:**

If the A/C Heater Control loses communication with the Memory Seat Module (MSM).

Refer to **DIAGNOSIS AND TESTING** for the diagnostic test procedure.

**\*HVAC SYSTEM TEST**

For complete wiring diagrams refer to **SYSTEM WIRING DIAGRAMS** article.

**Diagnostic Test**

**1) HVAC SYSTEM TEST**

**NOTE:** The HVAC System Test consists of four tests. Test 2 tests A/C system performance, Test 3 tests for mode switch, door actuator circuit, and auxiliary coolant pump circuit faults, Test 4 tests for shorted door actuator circuits, and Test 5 tests for door actuator calibration faults. Either perform all four tests for a complete system test or perform an individual test if diagnosing a specific symptom.

**NOTE:** Active DTCs must be resolved before diagnosing stored DTCs.

Start the engine.

With the scan tool, erase HVAC DTCs.

**Choose a diagnostic test to perform**

**Complete HVAC System Test**

Go to step 2).

**A/C System Performance Test**

Go to step 2).

**Mode Switch, Door Actuator CKT, & Auxiliary Coolant Pump CKT Test**

Go to step 3).

### Actuator DTC Detection Test

Go to step 4).

### Actuator Calibration Test

Go to step 5).

## 2) A/C SYSTEM PERFORMANCE TEST

**NOTE:** The work area ambient temperature must be above 15.6°C (60°F) and the evaporator temperature must be above 18.3°C (65°F) in order to test A/C system performance.

**NOTE:** Before actuating the Cooldown Test, verify that the mode setting is not in a defrost position and that the A/C compressor is not running. If the compressor is running, turn the A/C off and allow the evaporator to warm up before proceeding with the test.

**NOTE:** Running the Cooldown test will cause the A/C status indicator to flash.

**NOTE:** One or more status messages will display on the scan tool after running the Cooldown Test. These messages will clear after paging back out of this test function. Therefore, it is important to note all messages before doing so.

Set the mode to the Panel position.

Verify that the front blower motor operates correctly in all speeds. Diagnose and repair all blower related faults before proceeding with this test.

Set the front blower speed to high.

With the scan tool in HVAC, select System Tests and then select Cooldown test. Allow the test to run to completion.

**Does the scan tool display a status message that indicates a fault has occurred?**

### **Yes, Conditions Too Cold - Test Not Run**

If running, turn the A/C compressor off. Verify that the work area ambient temperature is above 15.6°C (60°F). If not, move the vehicle to a warmer work area. Verify that the evaporator temperature is above 18.3°C (65°F). If not, set the front blower to high speed and allow the blower to run for five minutes. Then, rerun the Cooldown Test.

### **Yes, Blowers Not On High - Test Not Run**

## 2007 Dodge Nitro R/T

2007 HVAC Heating & Air Conditioning - Electrical Diagnostics - Nitro

Set the front blower speed to high speed and then rerun the Cooldown Test.

### **Yes, No Results Stored/Test Not Complete**

Verify that power is not interrupted while rerunning the Cooldown Test.

**No**

Perform **BODY VERIFICATION TEST - VER 1**.

### **3) MODE SWITCH, DOOR ACTUATOR CIRCUIT, & AUXILIARY COOLANT PUMP CIRCUIT TEST**

**NOTE:** If at anytime a DTC becomes active during this test, proceed to the conclusion question.

**NOTE:** If multiple DTCs become active, diagnose those that relate to a short circuit first.

Set the front blower speed to low.

Set the Blend control to full cold.

Set the Mode control to Bi-Level/Recirc.

If equipped, set the Rear Fan switch on the Rear A/C Heater Control to off.

If equipped, set the Rear Blend switch on the Rear A/C Heater Control to full cold.

Monitor the scan tool for active HVAC DTCs while performing the following test steps.

Press the A/C mode switch on, wait 30 seconds, press it off, and then proceed to the next step.

Press the Rear Defrost mode switch on, wait 30 seconds, press it off, and then proceed to the next step.

Press and hold the Rear Washer mode switch for several seconds, release it, and then proceed to the next step.

Set the Blend control to full hot, wait 30 seconds and then set it to full cold.

Turn the Mode control to every door position. Leave it in each position for 30 seconds.

If equipped, set the Rear Blower control to Rear Control.

If equipped, set the Rear Fan switch on the Rear A/C Heater Control to high speed.

If equipped, slowly turn the Rear Blend switch on the Rear A/C Heater Control to full hot, wait 30 seconds and then turn it back to full cold.

If equipped, turn the Rear Fan switch on the Rear A/C Heater Control to off.

If equipped with rear HVAC, with the scan tool, select the following: Actuators, Auxiliary Coolant Pump, Start, and Constant On. Allow the pump to run for approximately one minute.

**Does the scan tool display any active DTCs?**

**Yes**

Diagnose and repair the DTC(s). Refer to the **DIAGNOSTIC CODE INDEX** for a complete list of HVAC related symptoms.

**No**

As necessary, either go to step 4) or step 5), or Perform **BODY VERIFICATION TEST - VER 1**.

**4) ACTUATOR DTC DETECTION TEST**

With the scan tool, select System Tests and then select Actuator DTC Detection. When the test is complete, select View DTCs.

**Does the scan tool display any DTCs?**

**Yes**

Diagnose and repair the DTC(s). If multiple DTCs are present, beginning with the common circuits, diagnose and repair all short high DTCs and then all short low DTCs. Refer to the **DIAGNOSTIC CODE INDEX** for a complete list of all HVAC related symptoms.

**No**

Perform **BODY VERIFICATION TEST - VER 1**.

**5) ACTUATOR CALIBRATION TEST**

With the scan tool, select System Tests and then select Actuator Calibration Test. When the test is complete, select View DTCs.

**Does the scan tool display any DTCs?**

**Yes**

Diagnose and repair the DTC(s). Refer to the **DIAGNOSTIC CODE INDEX** for a complete list of all HVAC related symptoms.

**2007 Dodge Nitro R/T**

2007 HVAC Heating & Air Conditioning - Electrical Diagnostics - Nitro

**No**

No problem found.

Perform **BODY VERIFICATION TEST - VER 1** .