

Name : _____

Finding Complementary Angles

Sheet 1

Find the value of x in each right angle.

1)

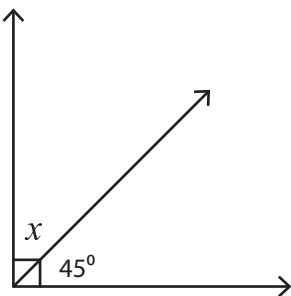

$x =$ _____

2)

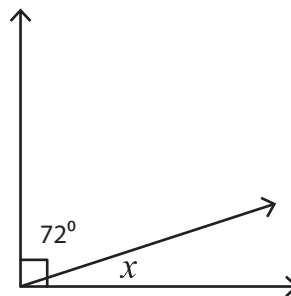

$x =$ _____

3)

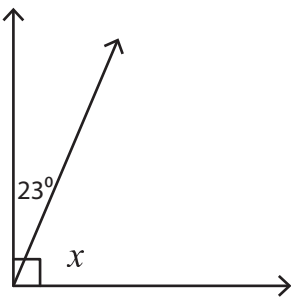

$x =$ _____

4)

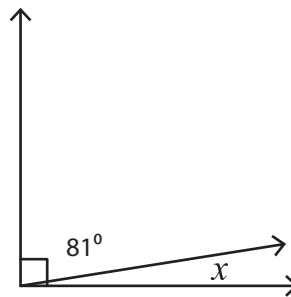

$x =$ _____

5)

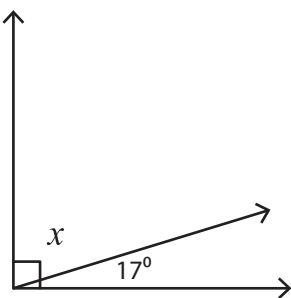

$x =$ _____

6)

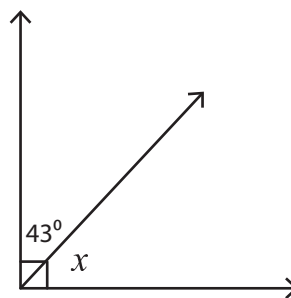

$x =$ _____

7)

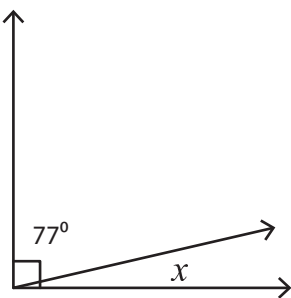

$x =$ _____

8)

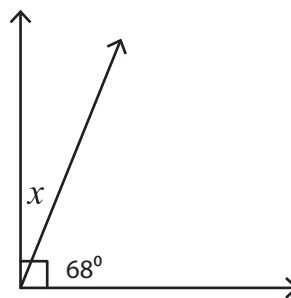

$x =$ _____

Name : _____

Finding Supplementary Angles

Sheet 3

Find the value of x in each supplementary angle pair.

1)

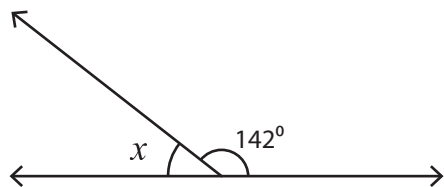

$x =$ _____

2)

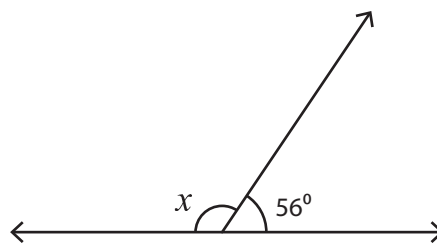

$x =$ _____

3)

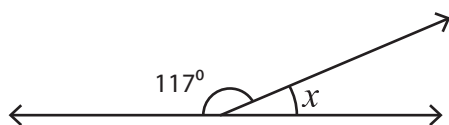

$x =$ _____

4)

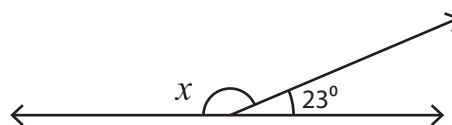

$x =$ _____

5)

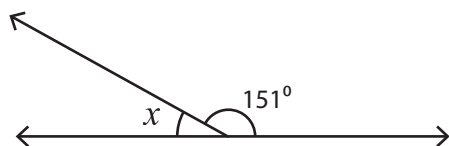

$x =$ _____

6)

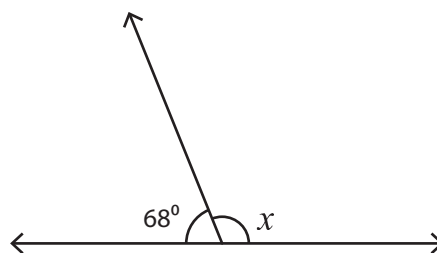

$x =$ _____

7)

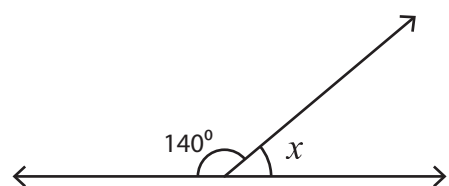

$x =$ _____

8)

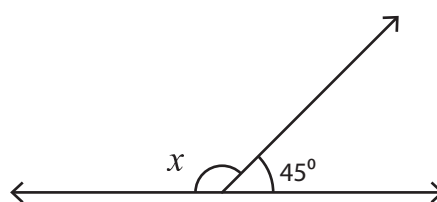

$x =$ _____

Name : _____

Exterior Angles

ES2

Find the value of each indicated angle.

1)

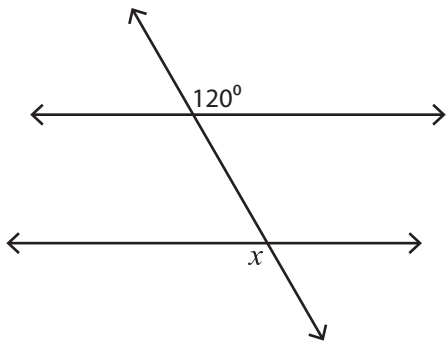

$x =$ _____

2)

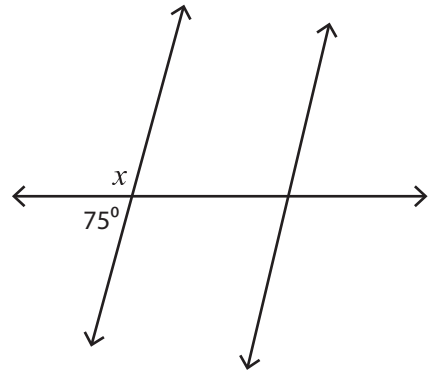

$x =$ _____

3)

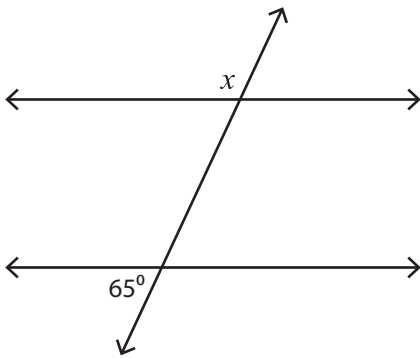

$x =$ _____

4)

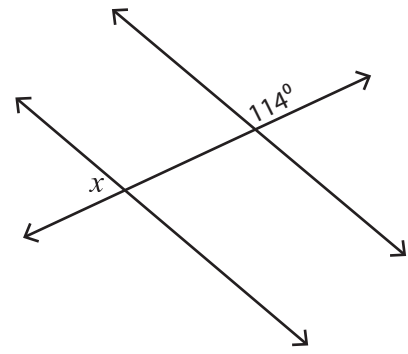

$x =$ _____

5)

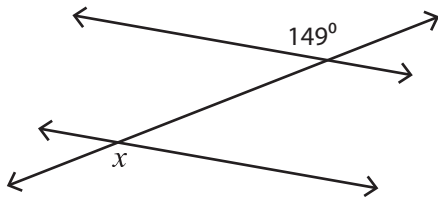

$x =$ _____

6)

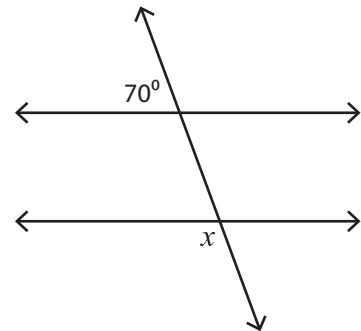

$x =$ _____

7)

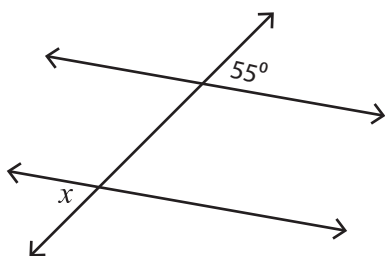

$x =$ _____

8)

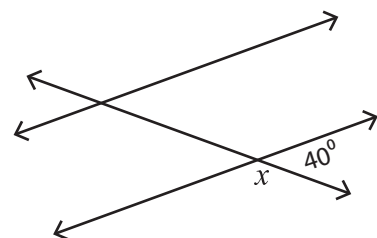

$x =$ _____

Name : _____

Interior Angles

ES1

Find the value of each indicated angle.

1)

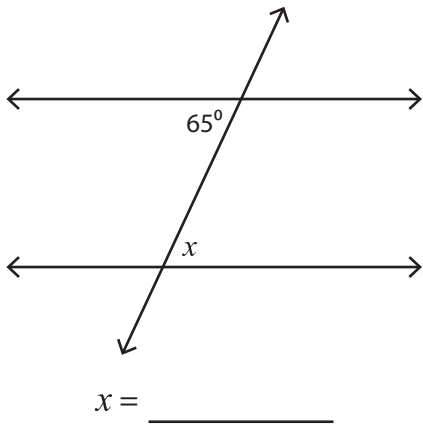

2)

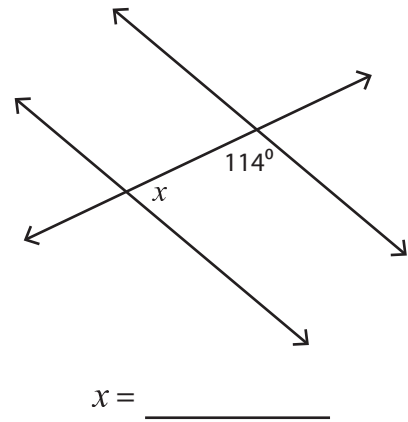

3)

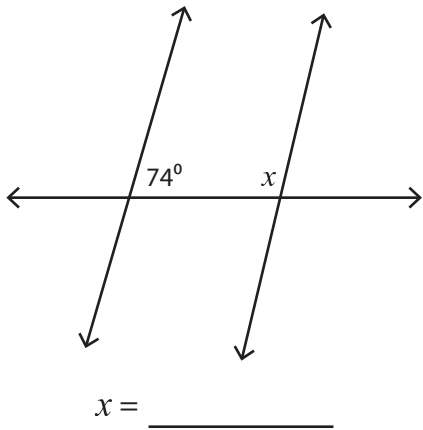

4)

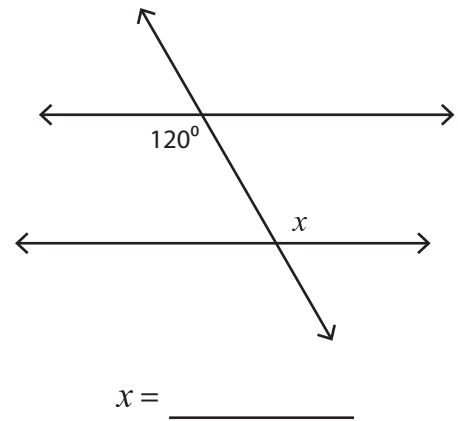

5)

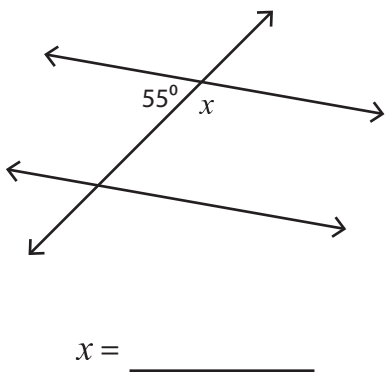

6)

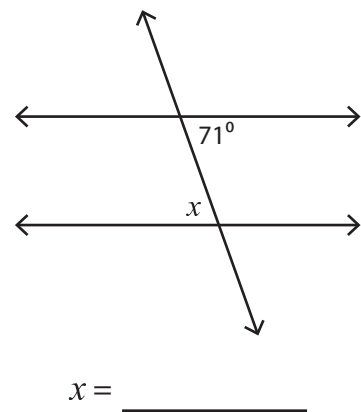

7)

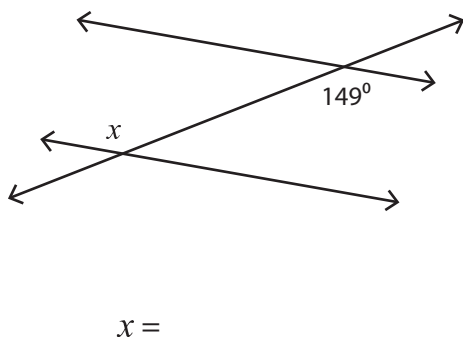

8)

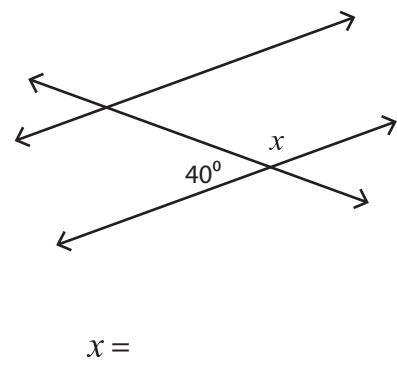

Angle Pairs - Transversal

MS1

Find the value of x .

1)

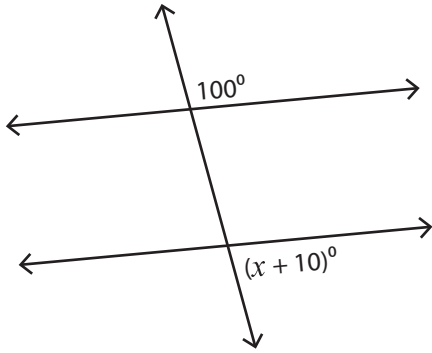

$x =$ _____

2)

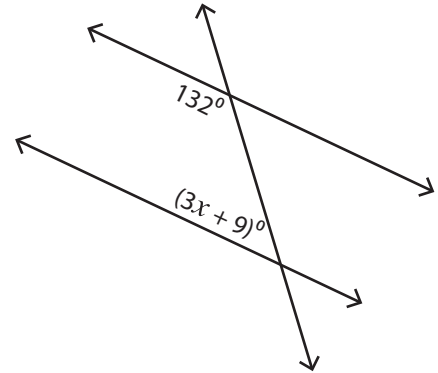

$x =$ _____

3)

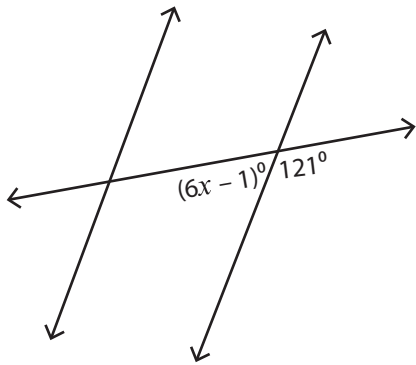

$x =$ _____

4)

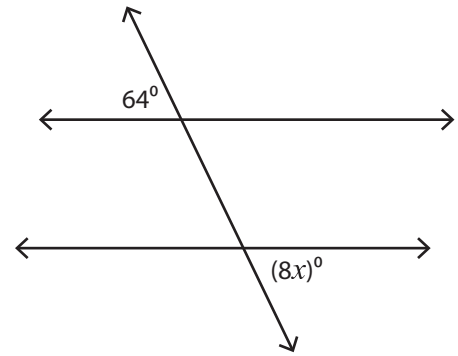

$x =$ _____

5)

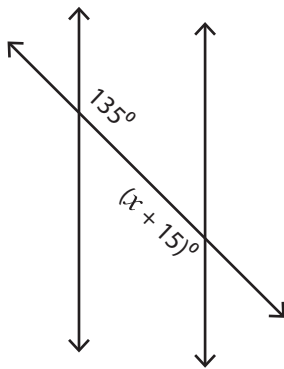

$x =$ _____

6)

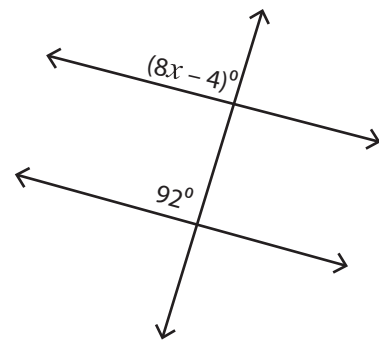

$x =$ _____

7)

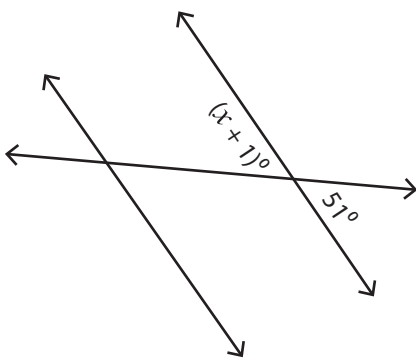

$x =$ _____

8)

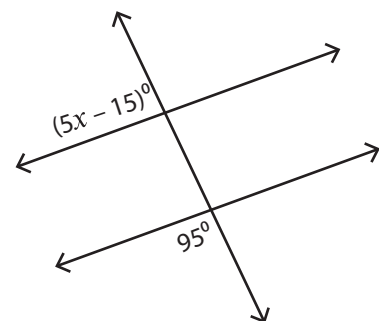

$x =$ _____