



Inspection Report

Truin Huntley and Daniel Carroll Huntley

Property Address:
12615 Concord Hall Dr
Alpharetta GA 30005



Inspector: Mike Gonzalez

Residential Inspector of America
3276 Buford Drive, Ste. 104-306
Buford, GA 30519
www.residentialinspector.com
770.476.4963

Table of Contents

<u>Cover Page.....</u>	<u>1</u>
<u>Table of Contents.....</u>	<u>2</u>
<u>Intro Page.....</u>	<u>3</u>
<u>Summary.....</u>	<u>4</u>
<u>1 Exterior.....</u>	<u>9</u>
<u>2 Garage.....</u>	<u>15</u>
<u>3 Structural Components.....</u>	<u>16</u>
<u>4 Roofing.....</u>	<u>17</u>
<u>5 Insulation and Ventilation.....</u>	<u>20</u>
<u>6 Heating / Central Air Conditioning.....</u>	<u>22</u>
<u>7 Electrical System.....</u>	<u>25</u>
<u>8 Plumbing System.....</u>	<u>27</u>
<u>9 Interiors.....</u>	<u>30</u>
<u>10 Built-In Kitchen Appliances.....</u>	<u>33</u>

Date: 1/24/2020	Time: 01:00:00 PM	Report ID: 012420GL572
Property: 12615 Concord Hall Dr Alpharetta GA 30005	Customer: Truin Huntley and Daniel Carroll Huntley	Real Estate Professional: Kristine Hoogacker Independent

All complete RIA home inspections come with these FREE services for home buyers:

5 Year Platinum Roof Leak Warranty 90 Day Structural/Mechanical Warranty

90 Day Mold Warranty 90 Day Main Sewer/Water Line Warranty

Concierge Service for Utility Set up 120 Day Radon Warranty (with test)

And FREE *RecallChek* on appliances for life! Click [HERE](#) to find out more.

REPORT VIDEOS

You are currently viewing a PDF version of this report. Your report may contain videos that you can view in the HTML version of this report by clicking [HERE](#).

IMPORTANT INFORMATION ABOUT THIS INSPECTION

RIA's home inspections are completed in accordance with the American Society of Home Inspectors Standards of Practice (ASHI), your RIA Inspection Agreement, and other RIA Terms & Conditions that are viewable by clicking [HERE](#) or by requesting an emailed copy. Please be sure that you fully read and understand these items. If an item is not listed in this report as "Inspected", then it is not part of this inspection and you should have the item further evaluated prior to your closing.

INSPECTED: The condition of the item at the time of inspection was evaluated and any necessary comments will be made in this report.

NOT INSPECTED: The item was not inspected for reasons noted in this report. If concerns exist regarding "Not Inspected" items, further evaluation is recommended.

REPAIR/REPLACE: The item is in need of repair, replacement, further evaluation by a specialist, or is of concern to the inspector.

NOT PRESENT: The item is not present in this home.

Standards of Practice:

ASHI American Society of Home Inspectors

In Attendance:

Customer

Type of building:

Single Family (2 story)

Approximate age of building:

Over 30 Years

Temperature:

Below 45

Weather:

Light Rain

Inspector:

Mike Gonzalez

Summary



Customer

Truin Huntley and Daniel Carroll Huntley

Address

12615 Concord Hall Dr
Alpharetta GA 30005

All complete RIA home inspections come with these FREE services to protect your investment: 5 Year Platinum Roof Leak Warranty, 90 Day Structural and Mechanical Warranty, 90 Day Mold Warranty, 90 Day Main Sewer and Water Line Warranty, 120 Radon Warranty (with test), Concierge Service, and RecallChek on appliances for life. Click [HERE](#) to find out more. Applies to home buyers only.

RIA's home inspections are completed in accordance with the ASHI Standards of Practice, your RIA Inspection Agreement, and other RIA Terms & Conditions. Click [HERE](#) to view.



This report may contain videos which can be seen by clicking the link on Page 3.

The items listed below are in need of repair, replacement, further evaluation, or are safety issues. All concerns related to items in this summary or throughout this report should be resolved prior to closing. If applicable, RIA can complete a re-inspection of completed repairs, moisture testing on stucco, mold testing, and radon gas testing. Please call our office or click [HERE](#) for more information. If LEFT and RIGHT directions are given in this summary, it is determined by facing the front of the home from the exterior.

1. Exterior



1.1 EXTERIOR SIDING

Repair or Replace

-  (1) Algae growth noted on the vinyl siding on the wall above the garage. It is recommended to have the siding pressure washed.
-  (2) One of the vinyl shutters at the front of the home has fallen off. Repair shutters as needed.

1.2 DOORS (Exterior)

Repair or Replace

-  (1) Recommend to seal the gap between the siding and the threshold of the exterior doors. Seal all miters where the brick mold meets the threshold to ensure that the area is water tight.
-  (2) Recommend to install a pressure treated piece of wood under the metal threshold at the bottom of the garage kitchen door. This will strengthen the threshold to keep it from bending or cracking.





1.3 WINDOWS

Repair or Replace

-  The glazing between glass panes are failing at the garage window due to age. This is common on single pane windows and the glazing compound is ready to be replaced to prevent windows from leaking and becoming drafty.



1.4 DECKS, STOOPS, STEPS, PORCHES, PATIO/ COVER AND RAILINGS

Repair or Replace

-  (1) Guardrails are loose and there are missing spindles on the rear deck and need additional bracing and/or fasteners to reduce the amount of movement on the rails. See photo(s) for location. Repair as needed.
-  (2) Limited visual of framing under deck due to low clearance of deck to the ground. Framing was observed from the edge.
-  (3) The deck framing is attached and not resting on its supports. Fasteners failed in shear withdrawal. Repair is needed by a deck construction professional.
-  (4) Rear decks usually last about 20+ years (depending on weather conditions) before needing replacement. Deck is nearing the end of its life. Older decks are not built to the codes in use today (flashing, construction, attachments). Based on the current condition of the deck it is recommended that a deck construction professional be consulted to determine the cost and scope of repair or replacement.

1.5 VEGETATION, GRADING, DRAINAGE, DRIVEWAYS, PATIO FLOOR, WALKWAYS AND RETAINING WALLS



Repair or Replace

-  (1) The soil at the rear of home is eroding. Silt travel is occurring and some form of ground cover or landscaping is needed. Recommend a qualified contractor to inspect and perform the necessary repair.
-  (2) The landscape at the left side of home may require a trench or drain if water stands or puddles near the home after heavy rain. Areas should be dry 24 to 48 hours after rainfall. Recommend to monitor and repair as needed. All rain water should drain at least 5 feet away from the home.
-  (3) Have all bushes cut away from the home at least 18"-24". This will discourage insects and water from entering the home.

2. Garage

2.2 GARAGE FLOOR

Repair or Replace

-  (1) Standing water was observed at the front left corner inside the garage. Improve exterior grades extend gutters and monitor as needed.
-  (2) Cracks in garage floor are not wide enough to be considered a structural concern and are due to normal settlement and shrinkage of the concrete. Have patched as needed.

2.3 GARAGE VEHICLE DOOR(S)

Repair or Replace

-  Daylight visible on the bottom of the garage vehicle door. This can be a rodent entry point. Adjust/install the weather stripping in these areas to prevent further entry.

4. Roofing

4.2 SKYLIGHTS, CHIMNEYS AND ROOF PENETRATIONS

Repair or Replace



-  Visible rusting noted on the chimney cap. When rusting is visible on the chimney cap then it is likely that it has become concave and standing water will eventually rust through allowing water to enter into the chase. Have roofing contractor or chimney sweep contractor inspect and make necessary repairs.

4.3 GUTTERS & DOWNSPOUTS

Repair or Replace

-  (1) Recommend to adjust the gutter at the garage and rear of home so that it properly slopes towards the downspout.

Residential Inspector of America

-  (2) Recommend to install a downspout extension to the downspout at the perimeter of the home. All roof water should drain at least 5 feet away from the home.
-  (3) Have all gutters and downspouts cleaned out around the home. Clean gutters are required to maintain water control and drainage.

4.4 WATER ENTRY IN ATTIC



Repair or Replace

-  Active roof leak was observed above the garage by the chimney chase and staining was observed in other areas of the attic. Roofer will need to evaluate roof and ensure that the roof covering is water tight. It is possible that outdoor and weather conditions could change and cause leaks to become active again. See photo(s) for location(s).

5. Insulation and Ventilation

5.1 VENTILATION OF ATTIC AND FOUNDATION AREAS

Repair or Replace

-  (1) A vinyl soffit has been installed without first removing the original plywood soffit creating inadequate ventilation for the attic. If the attic becomes too hot then the shingles may overheat prematurely. Increasing the ventilation to promote/maintain the life expectancy of the roof covering will be beneficial. Recommend to have roofing contractor inspect for further evaluation and make necessary repairs. See photo(s).
-  (2) The rear addition is not adequately vented. Recommend installing box vents for this portion of the home. Consult a roofing professional.

5.2 KITCHEN, BATHROOM AND LAUNDRY ROOM VENTS

Repair or Replace

-  Bath exhausts are venting into the attic. Bathroom vents should be vented outside. No adverse affects found in attic due vents being routed into the attic space.

6. Heating / Central Air Conditioning



6.0 HEATING EQUIPMENT

Repair or Replace

-  Have an HVAC tech service the heating and cooling equipment. Much of an HVAC system is concealed from view during a normal home inspection and our inspection is basic in scope, therefore, an HVAC company should always be consulted to determine if concealed defects or hazards are present. Furthermore, the system manufacturer recommends annual maintenance and servicing in order to keep the system operating properly.

6.6 COOLING AND AIR HANDLER EQUIPMENT

Repair or Replace

-  (1) The A/C was not tested for proper operation due to the outside air temperature being lower than 65 degrees. Testing the unit(s) during colder weather can damage them. Buyer should resolve all concerns prior to closing.
-  (2) Recommend to have the condensate drain lines and/or pump line(s) for the compressors extended out and away from the home. Water should drain at least 5 feet away from the home. This was not required in older homes.
-  (3) The Trane air conditioner is on a 40 amp breaker, but the data plate on the system states a 25 amp maximum. Properly sized breaker in the disconnect should be installed by licensed electrical professional.

7. Electrical System

7.5 OUTLETS & LIGHT FIXTURES

Repair or Replace



-  (1) The light fixture in the rear bedroom closet did not function at the time of inspection. Check bulb, repair of needed.

Residential Inspector of America

-  (2) The receptacle in the rear bedroom closet is loose to the wall. Repair as needed.

7.6 OPERATION OF GFCI & OR AFCI

Repair or Replace

-  (1) GFCI protection is missing for the receptacles under the electrical panel. All garage receptacles should be GFCI protected. Repair as needed.
-  (2) The two deck receptacles are not GFCI protected. All exterior receptacles should be GFCI protected. Repair as needed.
-  (3) Two receptacles on the range side of the kitchen are not GFCI protected. All kitchen receptacles should be GFCI protected. Repair as needed.

7.7 SMOKE DETECTORS

Repair or Replace

-  Recommend updating smoke detectors to meet current safety standards. Typically, there should be at least one smoke detector per level, one in each bedroom and one per hallway. There are different types of smoke detectors: *Ionization* and *Photoelectric*. *The National Fire Association recommends that smoke detectors be replaced every 10 years.*

7.8 CARBON MONOXIDE DETECTORS





Repair or Replace

-  Carbon Monoxide detector(s) could not be located in the home. It is recommended that one be installed according to the manufacturer's instructions. Ideally, there should be at least one per level.

8. Plumbing System

8.2 TUBS, SINKS, TOILETS & SHOWER STALLS

Repair or Replace

-  (1) The sink in the rear addition drained very slowly. Have the drain line checked for a possible clog.
-  (2) The hot and cold for the faucet in the first floor shower are reverse. Hot should be to the left unless marked by the manufacture. Recommend to have plumber inspect and make necessary repairs for safety.
-  (3) The spray head for the master bathtub was leaking at the time of inspection. Have the diverter valve evaluated by licensed plumbing professional.
-  (4) The master bath tub is loose to the floor. Repair as needed.

9. Interiors



9.0 CEILINGS

Repair or Replace

-  Recommend replacing the attic access panels to improve efficiency.

9.2 FLOORS

Repair or Replace

-  (1) Moisture staining was observed on the floor inside the window at the rear addition. This area should be evaluated by a window and deciding professional and repaired as needed.
-  (2) Damage was observed to the threshold between the dining room and rear addition. Have the threshold repaired for safety.

9.3 STEPS, STAIRWAYS, BALCONIES AND RAILINGS

Repair or Replace

-  It is recommended that the guard rails on the interior of the home be updated to today's building requirements with spindles with a 4" separation.

9.4 COUNTERS AND A REPRESENTATIVE NUMBER OF CABINETS

Repair or Replace

 Damage was observed in the cabinet under the kitchen sink. Repair damage as needed.

10. Built-In Kitchen Appliances

10.0 DISHWASHER

Repair or Replace

 The dishwasher is older and will likely need replacement in the near future. Dishwashers have structural, plumbing and electrical components and have a life span of about 10 years. Unit was tested during this inspection, but it is possible that more issues not evident during this inspection may arise in the future. Unit was tested for basic operation.

Prepared Using HomeGauge <http://www.HomeGauge.com> : Licensed To Michael Gonzalez

1. Exterior

Styles & Materials

Siding Material:

Vinyl

Items

1.0 ELEVATION PHOTOS

Comments: Inspected

Elevation photos.



1.0 Item 1(Picture)



1.0 Item 2(Picture)



1.0 Item 3(Picture)



1.0 Item 4(Picture)

1.1 EXTERIOR SIDING

Comments: Repair or Replace

🔧 (1) Algae growth noted on the vinyl siding on the wall above the garage. It is recommended to have the siding pressure washed.

🔧 (2) One of the vinyl shutters at the front of the home has fallen off. Repair shutters as needed.



1.1 Item 1(Picture)

1.2 DOORS (Exterior)

Comments: Repair or Replace

🔧 (1) Recommend to seal the gap between the siding and the threshold of the exterior doors. Seal all miters where the brick mold meets the threshold to ensure that the area is water tight.



1.2 Item 1(Picture)

🔧 (2) Recommend to install a pressure treated piece of wood under the metal threshold at the bottom of the garage kitchen door. This will strengthen the threshold to keep it from bending or cracking.



1.2 Item 2(Picture)

1.3 WINDOWS

Comments: Repair or Replace

🔧 The glazing between glass panes are failing at the garage window due to age. This is common on single pane windows and the glazing compound is ready to be replaced to prevent windows from leaking and becoming drafty.



1.3 Item 1(Picture)

1.4 DECKS, STOOPS, STEPS, PORCHES, PATIO/ COVER AND RAILINGS

Comments: Repair or Replace

🔧 (1) Guardrails are loose and there are missing spindles on the rear deck and need additional bracing and/or fasteners to reduce the amount of movement on the rails. See photo(s) for location. Repair as needed.



1.4 Item 1(Picture)

🔧 (2) Limited visual of framing under deck due to low clearance of deck to the ground. Framing was observed from the edge.

🔧 (3) The deck framing is attached and not resting on its supports. Fasteners failed in shear and withdrawal. Repair is needed by a deck construction professional.

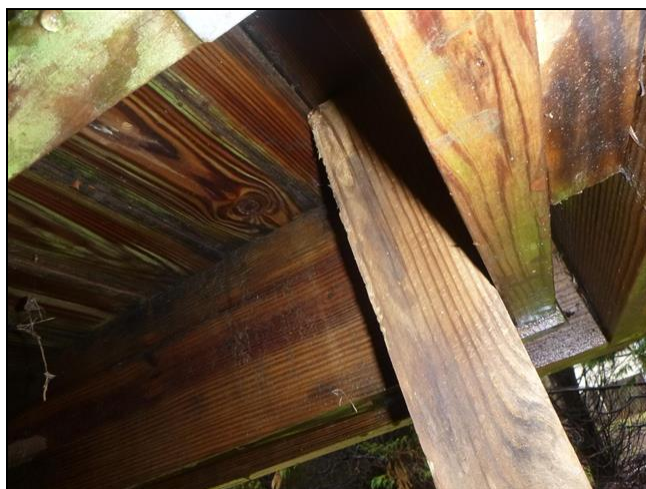

1.4 Item 2(Picture)

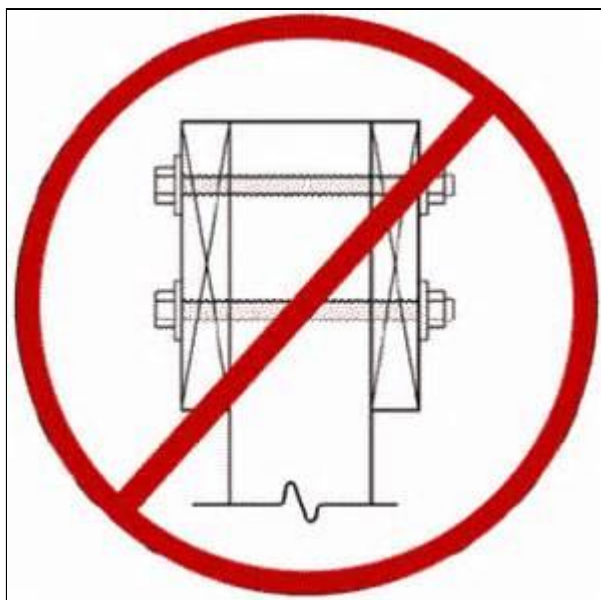

1.4 Item 3(Picture)

🔧 (4) Rear decks usually last about 20+ years (depending on weather conditions) before needing replacement. Deck is nearing the end of its life. Older decks are not built to the codes in use today (fastening, construction, attachments). Based on the current condition of the deck it is recommended that a deck construction professional be consulted to determine the cost and scope of repair or replacement.

1.5 VEGETATION, GRADING, DRAINAGE, DRIVEWAYS, PATIO FLOOR, WALKWAYS AND RETAINING WALLS

Comments: Repair or Replace

🔧 (1) The soil at the rear of home is eroding. Silt travel is occurring and some form of ground cover or landscaping is needed. Recommend a qualified contractor to inspect and perform the necessary repair.



1.5 Item 1(Picture)

🔧 (2) The landscape at the left side of home may require a trench or drain if water stands or puddles near the home after heavy rain. Areas should be dry 24 to 48 hours after rainfall. Recommend to monitor and repair as needed. All rain water should drain at least 5 feet away from the home.



1.5 Item 2(Picture)

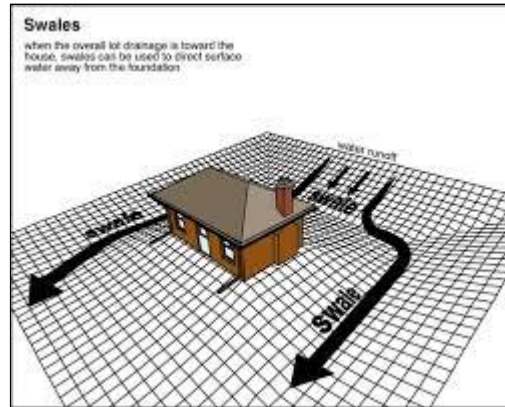

1.5 Item 3(Picture)

🔧 (3) Have all bushes cut away from the home at least 18"-24". This will discourage insects and water from entering the home.



1.5 Item 4(Picture)

1.6 EAVES, SOFFITS AND FASCIAS

Comments: Inspected

1.7 EXTERIOR WOOD TRIM

Comments: Inspected

2. Garage

Items

2.0 GARAGE CEILINGS

Comments: Inspected

2.1 GARAGE WALLS

Comments: Inspected

2.2 GARAGE FLOOR

Comments: Repair or Replace

🔧 (1) Standing water was observed at the front left corner inside the garage. Improve exterior grades extend gutters and monitor as needed.

🔧 (2) Cracks in garage floor are not wide enough to be considered a structural concern and are due to normal settlement and shrinkage of the concrete. Have patched as needed.

2.3 GARAGE VEHICLE DOOR(S)

Comments: Repair or Replace

🔧 Daylight visible on the bottom of the garage vehicle door. This can be a rodent entry point. Adjust/install the weather stripping in these areas to prevent further entry.



2.3 Item 1(Picture)

2.4 GARAGE DOOR VEHICLE OPENER(S)

Comments: Inspected

2.5 OCCUPIANT DOOR FROM THE INSIDE OF THE HOME TO THE GARAGE

Comments: Inspected

3. Structural Components

Styles & Materials

Foundation:

Poured in place concrete slab

Columns or Piers:

Supporting walls

Roof Structure:

2x4 engineered wood trusses 24" on center

OSB Sheathing

Method used to observe attic:

Crawled

Items

3.0 FOUNDATIONS, BASEMENTS AND CRAWLSPACES

Comments: Inspected

3.1 WALLS (Structural)

Comments: Inspected

3.2 COLUMNS OR PIERS

Comments: Inspected

3.3 FLOORS (Structural)

Comments: Inspected

3.4 CEILINGS (structural)

Comments: Inspected

3.5 ROOF STRUCTURE AND ATTIC

Comments: Inspected

4. Roofing

Styles & Materials

Roof Material:

4-Tab architectural fiberglass shingles

Viewed roof material from:

Ground

Items

4.0 ROOF COVERINGS

Comments: Inspected

4.1 FLASHINGS

Comments: Inspected

4.2 SKYLIGHTS, CHIMNEYS AND ROOF PENETRATIONS

Comments: Repair or Replace

🔧 Visible rusting noted on the chimney cap. When rusting is visible on the chimney cap then it is likely that it has become concave and standing water will eventually rust through allowing water to enter into the chase. Have roofing contractor or chimney sweep contractor inspect and make necessary repairs.



4.2 Item 1(Picture)

4.3 GUTTERS & DOWNSPOUTS

Comments: Repair or Replace

🔧 (1) Recommend to adjust the gutter at the garage and rear of home so that it properly slopes towards the downspout.



4.3 Item 1(Picture)



4.3 Item 2(Picture)

🔧 (2) Recommend to install a downspout extension to the downspout at the perimeter of the home. All roof water should drain at least 5 feet away from the home.



4.3 Item 3(Picture)

🔧 (3) Have all gutters and downspouts cleaned out around the home. Clean gutters are required to maintain water control and drainage.



4.3 Item 4(Picture)

4.4 WATER ENTRY IN ATTIC

Comments: Repair or Replace

🔧 Active roof leak was observed above the garage by the chimney chase and staining was observed in other areas of the attic. Roofer will need to evaluate roof and ensure that the roof covering is water tight. It is possible that outdoor and weather conditions could change and cause leaks to become active again. See photo(s) for location(s).



4.4 Item 1(Picture)



4.4 Item 2(Picture)



4.4 Item 3(Picture)

5. Insulation and Ventilation

Styles & Materials

Attic Insulation:

Batt
Fiberglass
R-30 or better

Roof Ventilation:

Gable vents
Ridge vents
Soffit Vents

Items

5.0 INSULATION IN ATTIC

Comments: Inspected

5.1 VENTILATION OF ATTIC AND FOUNDATION AREAS

Comments: Repair or Replace

🔧 (1) A vinyl soffit has been installed without first removing the original plywood soffit creating inadequate ventilation for the attic. If the attic becomes too hot then the shingles may overheat prematurely. Increasing the ventilation to promote/maintain the life expectancy of the roof covering will be beneficial. Recommend to have roofing contractor inspect for further evaluation and make necessary repairs. See photo(s).



5.1 Item 1(Picture)



5.1 Item 2(Picture)

🔧 (2) The rear addition is not adequately vented. Recommend installing box vents for this portion of the home. Consult a roofing professional.



5.1 Item 3(Picture)

5.2 KITCHEN, BATHROOM AND LAUNDRY ROOM VENTS

Comments: Repair or Replace

 Bath exhausts are venting into the attic. Bathroom vents should be vented outside. No adverse affects found in attic due vents being routed into the attic space.

6. Heating / Central Air Conditioning

Styles & Materials

Heating Equipment Type: Forced Air	Heating Equipment Age: 2015 2019	Number of Heat Systems (excluding wood): Two
Heat Temp: The main level heat read 117 degrees. Extra Info : Addition heat read 110°	Operable Fireplaces: One	Cooling Equipment Type: Central forced Air A/C
Cooling Equipment Age: 2015 2019	Number of AC Only Units: Two	A/C Temp: The A/C was not tested at the time of the inspection due to the exterior temperatures.

Items

6.0 HEATING EQUIPMENT

Comments: Repair or Replace

 Have an HVAC tech service the heating and cooling equipment. Much of an HVAC system is concealed from view during a normal home inspection and our inspection is basic in scope, therefore, an HVAC company should always be consulted to determine if concealed defects or hazards are present. Furthermore, the system manufacturer recommends annual maintenance and servicing in order to keep the system operating properly.

6.1 NORMAL OPERATING CONTROLS/ THERMOSTAT

Comments: Inspected

6.2 DISTRIBUTION SYSTEMS (including fans, pumps, ducts and piping, with supports, insulation, air filters, registers, radiators, fan coil units and convectors)

Comments: Inspected

6.3 PRESENCE OF INSTALLED HEAT SOURCE IN EACH ROOM

Comments: Inspected

6.4 CHIMNEYS, FLUES AND VENTS (for fireplaces, gas water heaters or heat systems)

Comments: Inspected

6.5 GAS FIRELOGS AND FIREPLACES

Comments: Inspected

6.6 COOLING AND AIR HANDLER EQUIPMENT

Comments: Repair or Replace

👉 (1) The A/C was not tested for proper operation due to the outside air temperature being lower than 65 degrees. Testing the unit(s) during colder weather can damage them. Buyer should resolve all concerns prior to closing.

👉 (2) Recommend to have the condensate drain lines and/or pump line(s) for the compressors extended out and away from the home. Water should drain at least 5 feet away from the home. This was not required in older homes.



6.6 Item 1(Picture)

👉 (3) The Trane air conditioner is on a 40 amp breaker, but the data plate on the system states a 25 amp maximum. Properly sized breaker in the disconnect should be installed by licensed electrical professional.

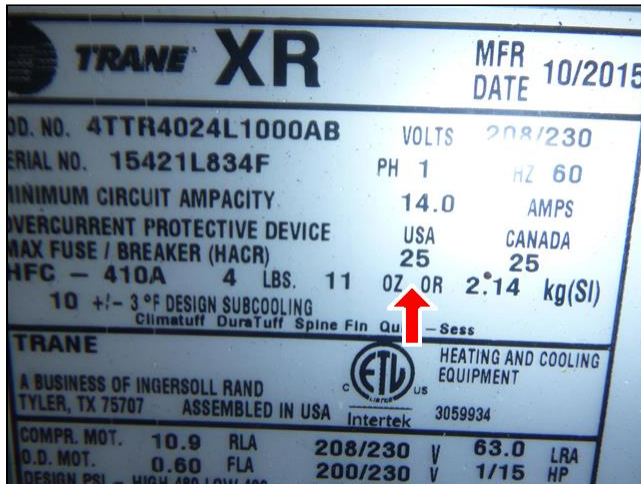

6.6 Item 2(Picture)



6.6 Item 3(Picture)

(4) Photo(s) of A/C unit(s).



6.6 Item 4(Picture)



6.6 Item 5(Picture)



6.6 Item 6(Picture)

6.7 PRESENCE OF INSTALLED COOLING SOURCE IN EACH ROOM

Comments: Inspected

7. Electrical System

Styles & Materials

Panel capacity:

150 AMP

Panel Type:

Circuit breakers

Wiring Methods:

Non-metallic Sheathed Cable

Branch wire 15 and 20 AMP:

Copper

Items

7.0 SERVICE ENTRANCE CONDUCTORS & MAIN DISCONNECT BREAKER

Comments: Inspected

7.1 SERVICE GROUNDING

Comments: Inspected

7.2 PANEL BOX & SUB-PANEL

Comments: Inspected

7.3 LOCATION OF MAIN AND DISTRIBUTION PANELS

Comments: Inspected

The main panel box is located at the garage. However, the main disconnect (shut-off) is outside at meter base panel (for your information).



7.3 Item 1(Picture)

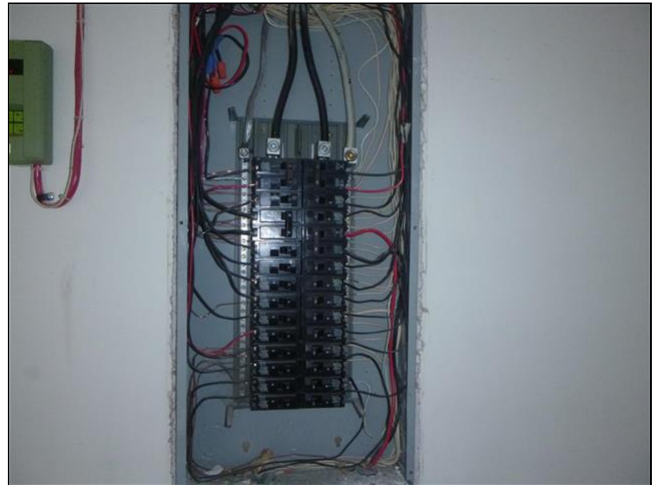

7.3 Item 2(Picture)

7.4 BRANCH CIRCUIT CONDUCTORS, CIRCUIT BREAKERS & WIRING

Comments: Inspected

7.5 OUTLETS & LIGHT FIXTURES

Comments: Repair or Replace

🔧 (1) The light fixture in the rear bedroom closet did not function at the time of inspection. Check bulb, repair of needed.

🔧 (2) The receptacle in the rear bedroom closet is loose to the wall. Repair as needed.



7.5 Item 1(Picture)

7.6 OPERATION OF GFCI & OR AFCI

Comments: Repair or Replace

🔧 (1) GFCI protection is missing for the receptacles under the electrical panel. All garage receptacles should be GFCI protected. Repair as needed.

🔧 (2) The two deck receptacles are not GFCI protected. All exterior receptacles should be GFCI protected. Repair as needed.

🔧 (3) Two receptacles on the range side of the kitchen are not GFCI protected. All kitchen receptacles should be GFCI protected. Repair as needed.

7.7 SMOKE DETECTORS

Comments: Repair or Replace

🔧 Recommend updating smoke detectors to meet current safety standards. Typically, there should be at least one smoke detector per level, one in each bedroom and one per hallway. There are different types of smoke detectors: *Ionization* and *Photoelectric*. *The National Fire Association recommends that smoke detectors be replaced every 10 years.*

7.8 CARBON MONOXIDE DETECTORS

Comments: Repair or Replace

🔧 Carbon Monoxide detector(s) could not be located in the home. It is recommended that one be installed according to the manufacturer's instructions. Ideally, there should be at least one per level.

8. Plumbing System

Styles & Materials

Water Source: Public	Plumbing Water Supply (into home): Copper	Plumbing Water Distribution (inside home): Copper
Plumbing Drain Pipe: PVC	Water Heater Power Source: Gas	Water Heater Capacity: 40 Gallon
Water Heater Location: Garage utility room	Water Heater Age: 2016	

Items

8.0 PLUMBING DRAIN, WASTE AND VENT SYSTEMS

Comments: Inspected

8.1 PLUMBING WATER SUPPLY AND DISTRIBUTION PIPING AND FIXTURES

Comments: Inspected

Annual Maintenance - Recommend to have all exterior water faucets/pipes winterized for the colder months. All pipes that are exposed to the elements or *not* in conditioned space (unfinished/non-insulated basement or crawlspace) should have insulation around them to prevent potential damage.

8.2 TUBS, SINKS, TOILETS & SHOWER STALLS

Comments: Repair or Replace

🔧 (1) The sink in the rear addition drained very slowly. Have the drain line checked for a possible clog.

🔧 (2) The hot and cold for the faucet in the first floor shower are reverse. Hot should be to the left unless marked by the manufacture. Recommend to have plumber inspect and make necessary repairs for safety.

🔧 (3) The spray head for the master bathtub was leaking at the time of inspection. Have the diverter valve evaluated by licensed plumbing professional.

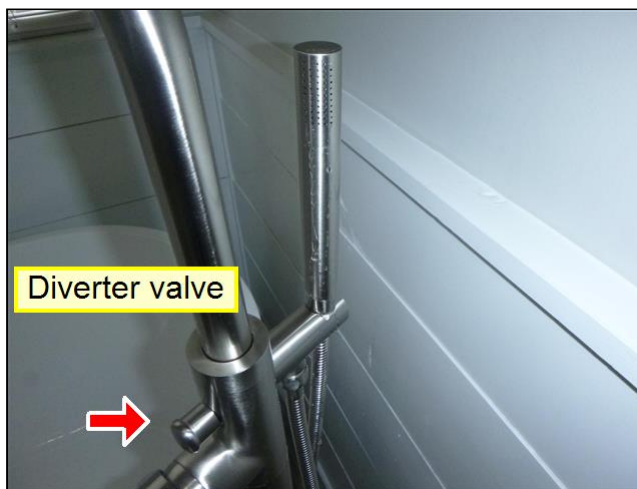

8.2 Item 1(Picture)

🔧 (4) The master bath tub is loose to the floor. Repair as needed.

8.3 WATER HEATER

Comments: Inspected

The water heater is located in the garage storage room. This is for your information.



8.3 Item 1(Picture)

8.4 MAIN WATER SHUT-OFF DEVICE (Describe location)

Comments: Inspected

The main water shut-off is the knob located in the garage. This is for your information. See photo.



8.4 Item 1(Picture)

8.5 MAIN FUEL GAS SHUT OFF

Comments: Inspected

The main gas shut off is located at the meter on the side of the home.



8.5 Item 1(Picture)

8.6 SEWAGE EJECTOR PUMP

Comments: Inspected

9. Interiors

Items

9.0 CEILINGS

Comments: Repair or Replace

🔧 Recommend replacing the attic access panels to improve efficiency.



9.0 Item 1(Picture)

9.1 WALLS

Comments: Inspected

9.2 FLOORS

Comments: Repair or Replace

🔧 (1) Moisture staining was observed on the floor inside the window at the rear addition. This area should be evaluated by a window and deciding professional and repaired as needed.

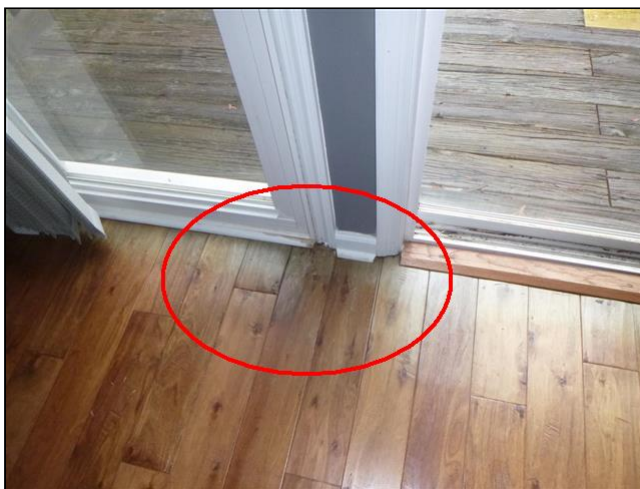

9.2 Item 1(Picture)

🔧 (2) Damage was observed to the threshold between the dining room and rear addition. Have the threshold repaired for safety.



9.2 Item 2(Picture)

9.3 STEPS, STAIRWAYS, BALCONIES AND RAILINGS

Comments: Repair or Replace

🔧 It is recommended that the guard rails on the interior of the home be updated to today's building requirements with spindles with a 4" separation.



9.3 Item 1(Picture)

9.4 COUNTERS AND A REPRESENTATIVE NUMBER OF CABINETS

Comments: Repair or Replace

 Damage was observed in the cabinet under the kitchen sink. Repair damage as needed.



9.4 Item 1(Picture)

9.5 INTERIOR DOORS

Comments: Inspected

9.6 WINDOWS

Comments: Inspected

9.7 BATHROOMS

Comments: Inspected

10. Built-In Kitchen Appliances

Items

10.0 DISHWASHER

Comments: Repair or Replace

 The dishwasher is older and will likely need replacement in the near future. Dishwashers have structural, plumbing and electrical components and have a life span of about 10 years. Unit was tested during this inspection, but it is possible that more issues not evident during this inspection may arise in the future. Unit was tested for basic operation.

10.1 RANGES/OVENS/COOKTOPS

Comments: Inspected

10.2 VENT HOOD/DOWN DRAFT

Comments: Inspected

10.3 GARBAGE DISPOSAL

Comments: Inspected

10.4 MICROWAVE

Comments: Not Present